

Low Phase Noise C band HBT VCO

GaAs Monolithic Microwave IC

Description

The CHV1206a98F is a low phase noise C band HBT voltage controlled oscillator that integrates negative resistor, varactors and buffer amplifiers. It provides an excellent phase noise of 100dBc/Hz at 100kHz offset.

It is designed for a wide range of applications, from space to commercial communication systems.

The circuit is fully integrated on InGaP HBT process: 2µm emitter length, via holes through the substrate and high Q passive elements.

It is available in chip form.

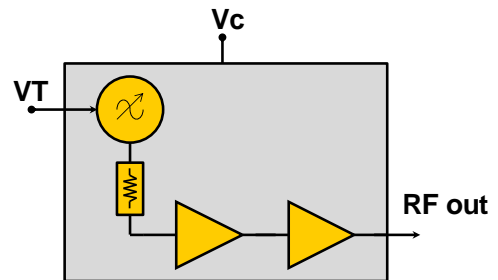

Main Features

- C-band VCO + C buffers
- Fully integrated VCO (no need for external resonator)
- Low phase noise
- High frequency stability
- On chip self-biased devices
- Available in bare die
- Chip size: 2.7x2.7x0.1mm

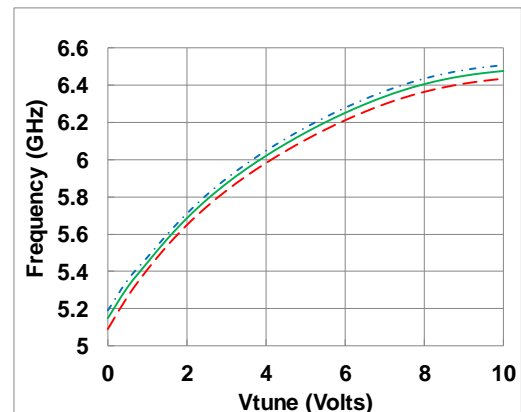

Main Electrical Characteristics

Tamb.= +25°C

Symbol	Parameter	Min	Typ	Max	Unit
F_out	Output frequency range on RF_out port	5.35		6.1	GHz
P_out	Output power on RF_out port		8.5		dBm
PN_100	SSB Phase Noise @ F_out @ 100KHz offset		100		dBc/Hz

Electrical Characteristics

Tamb.= +25°C, Vd = +3V

Symbol	Parameter	Min	Typ	Max	Unit
F_out	Output frequency range	5.35		6.1	GHz
V_Tune	Voltage Tuning range	0		10	V
	Tuning sensitivity	110		275	MHz/V
	Frequency drift rate		0.9		MHz/°C
H1	Harmonics 1/2 F_out rejection		58		dBc
H3	Harmonics 3/2 F_out rejection		56		dBc
H4	Harmonics 2 F_out rejection		28		dBc
PN_10	SSB Phase Noise given @ F_out @ 10 kHz		-78		dBc/Hz
PN_100	SSB Phase Noise given @ F_out @ 100 kHz		-100		dBc/Hz
	Output (RF_Out) Return loss		12		dB
	Pulling into 2:1 VSWR for all phases		0.3		MHz
	Pushing vs Vc		13		MHz/V
P_out	Output Power on RF_out port		8.5		dBm
	Output power variation vs Tuning Voltage		1.2		dB
Vc	Positive supply voltage		3	3.5	V
I_Vc	Positive supply current		75		mA

These values are representative of measurements on board that are made with bonding wires at the RF port.

A bonding wire of typically 0.3nH will improve the matching at the accesses.

Absolute Maximum Ratings ⁽¹⁾

Tamb.= +25°C

Symbol	Parameter	Values	Unit
VT	Tuning voltage	15	V
Vd	Drain bias voltage	4	V
Id	Drain bias current	110	mA
Tj	Junction temperature	175	°C
Ta	Operating temperature range	-55 to +125	°C
Tstg	Storage temperature range	-55 to +150	°C

⁽¹⁾ Operation of this device above anyone of these parameters may cause permanent damage.

Typical Bias Conditions

Tamb.= +25°C

Symbol	Pad N°	Parameter	Values	Unit
Vc	VC	Positive voltage supply	3	V
VT	VT	Tuning Voltage	0 to 10	V

Typical Measurements on Boards

Temperature = -20, +25, +85°C, Vd = +3.0V, Id = 75mA

Output frequency versus Vtune

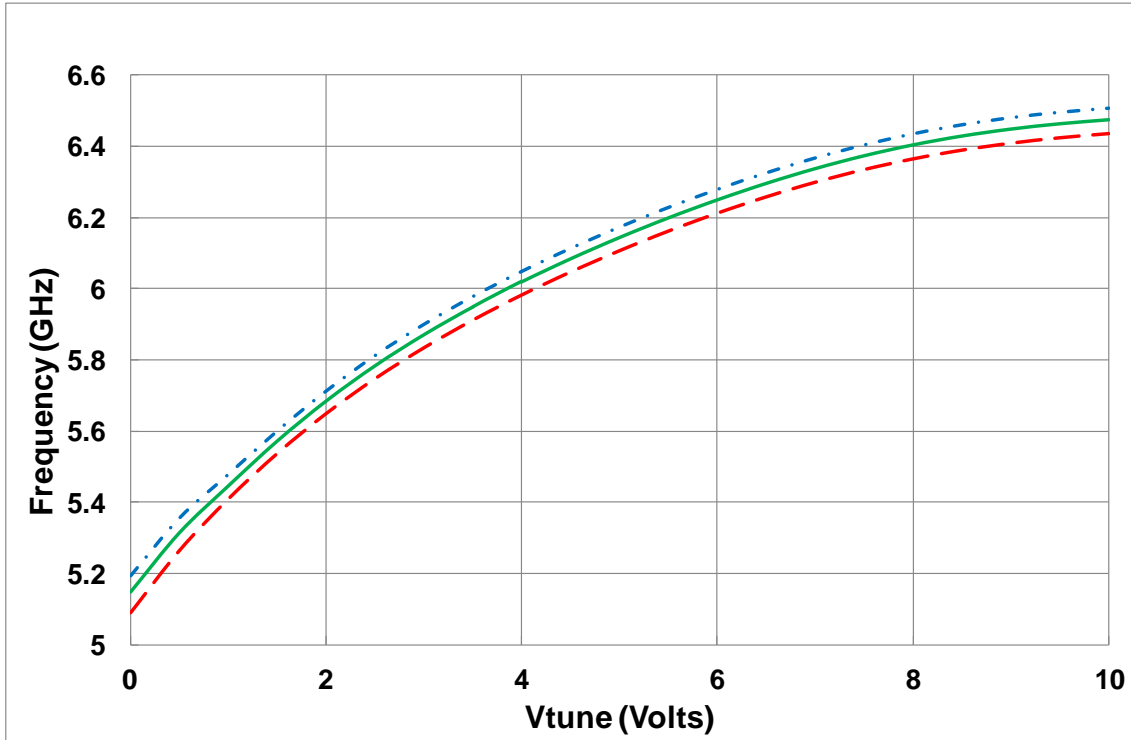

Sensitivity versus Vtune

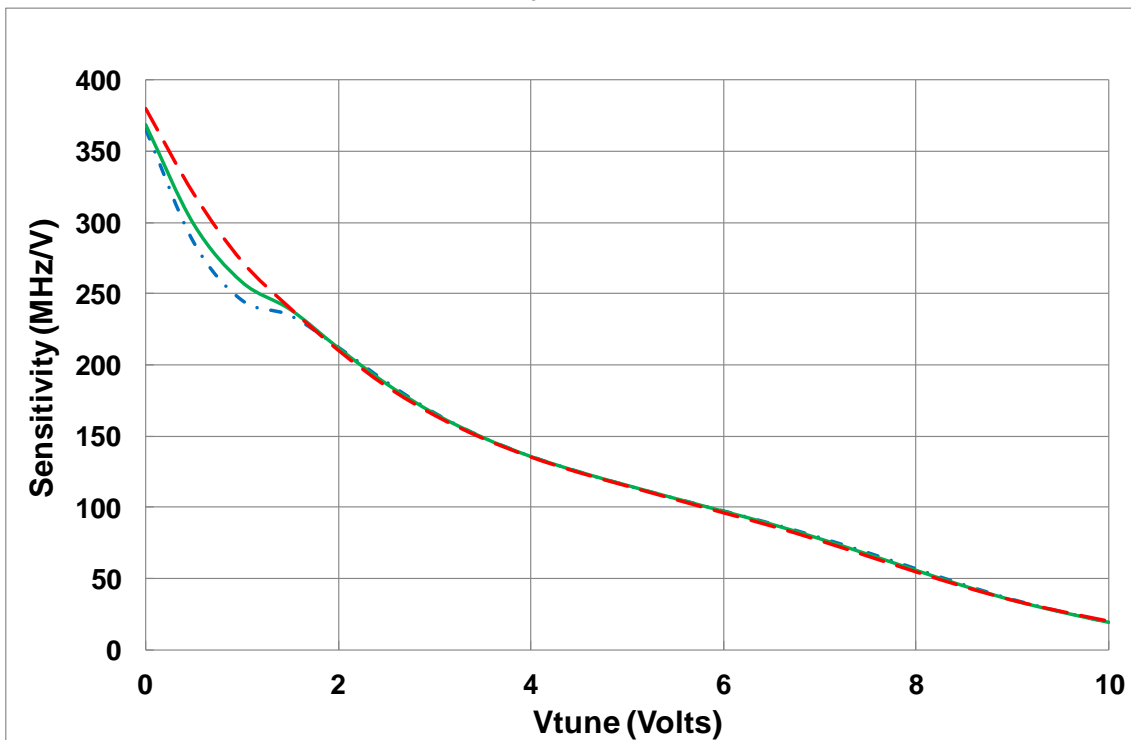

Typical Measurements on Boards

Temperature = -20, +25, +85°C Vd = +3.0V, Id = 75mA

Output power versus frequency

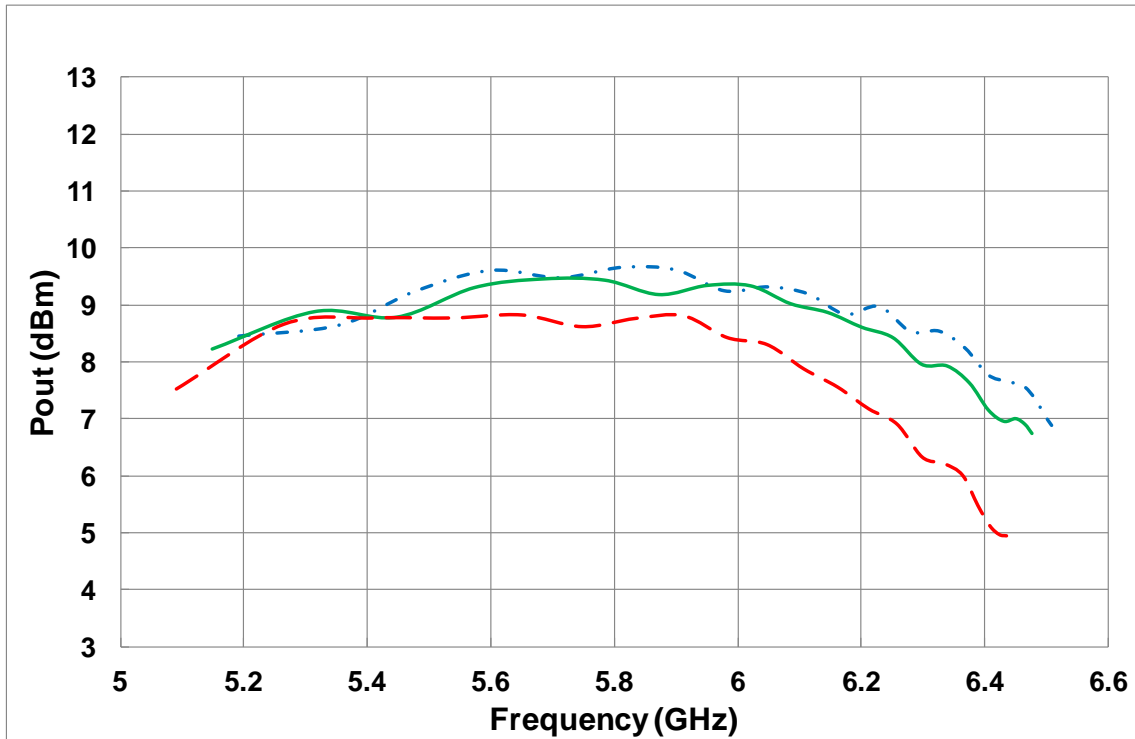

Positive current versus frequency

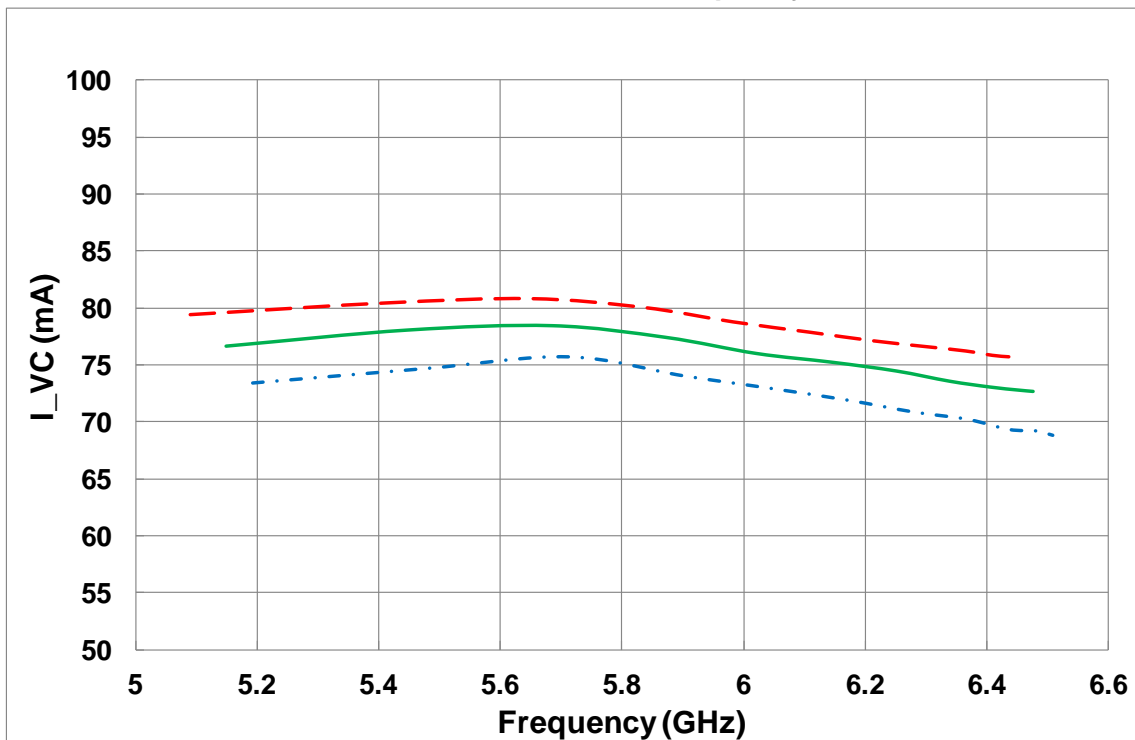

Typical Measurements on Boards

Temperature = -20, +25, +85°C, Vd = +3.0V, Id = 75mA

Phase Noise @ 10kHz versus frequency

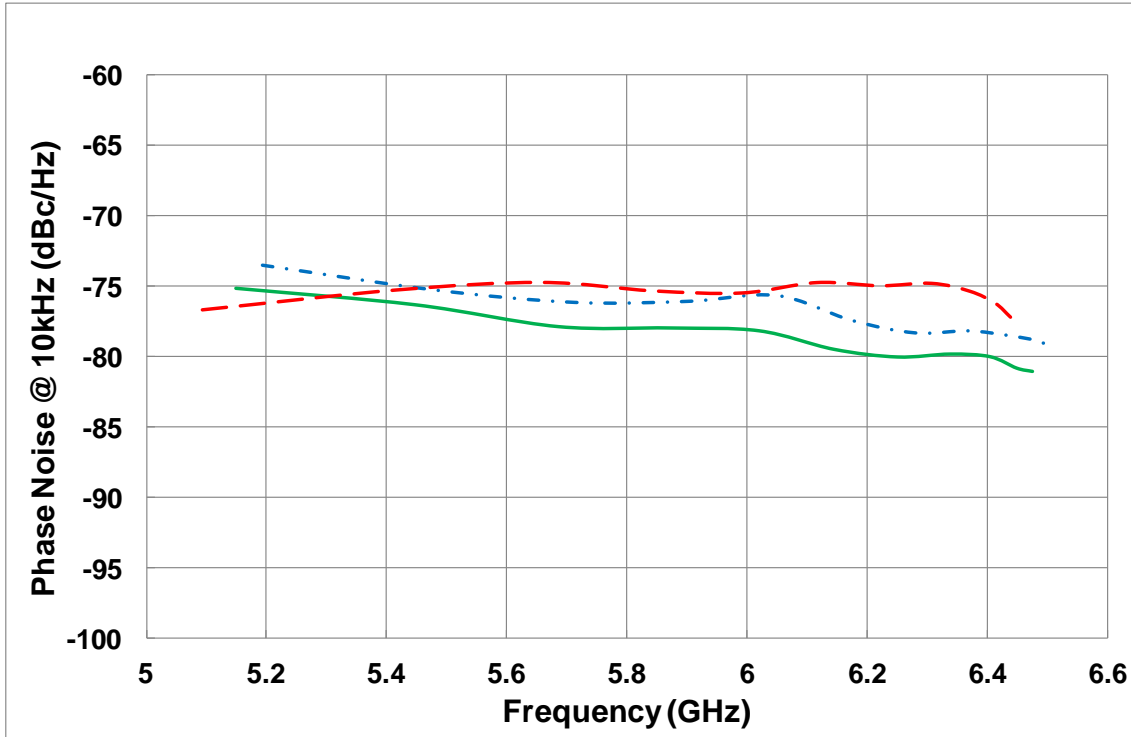

Phase Noise @ 100kHz versus frequency

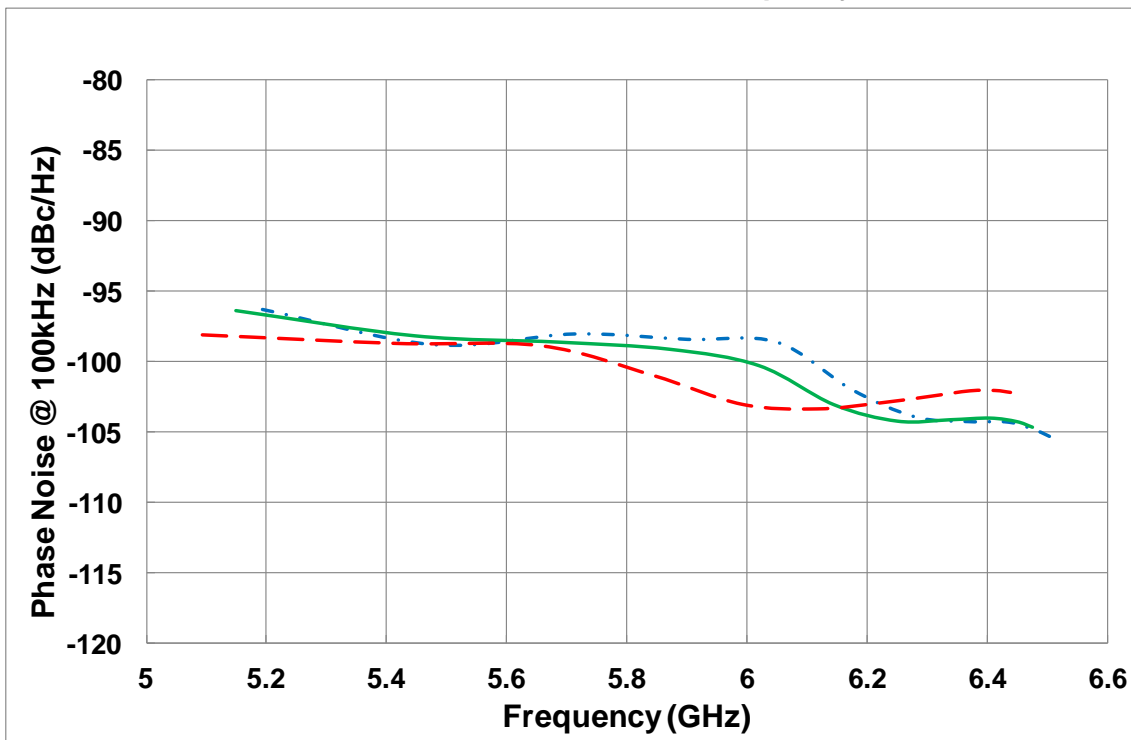

Mechanical data

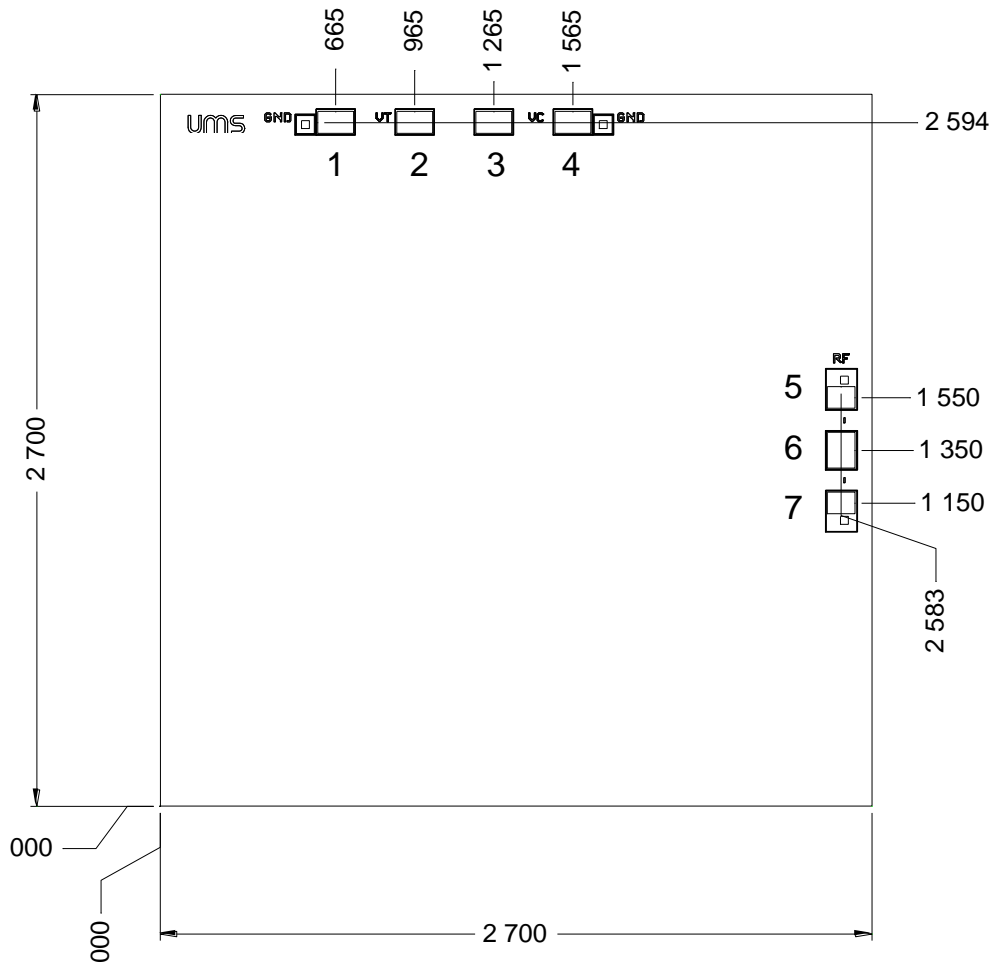

UNITS : μm
Tol : $\pm 35\mu\text{m}$

All dimensions are in micrometers
 Chip size = 2700 x 2700
 Chip thickness = $100\mu\text{m} \pm 10\mu\text{m}$
 RF pad = $110 \times 200\mu\text{m}^2$
 DC pads = $100 \times 100\mu\text{m}^2$
 Chip width and length are given with a tolerance of $\pm 35\mu\text{m}$

PAD Number	Name	Description
6	RF OUT	Output RF port
1, 4, 5, 7	GND	Ground (NC)
2	VT	Varactor Tuning voltage
3	VC	Positive supply voltage

Recommended assembly plan

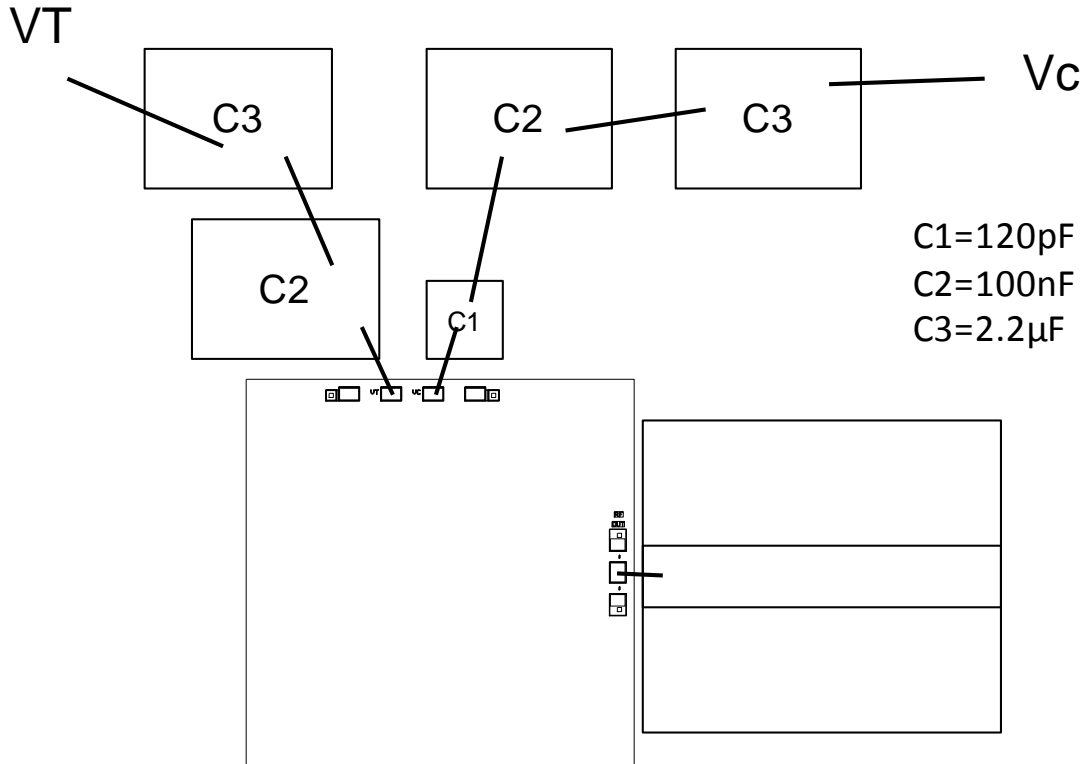

Note: 25µm diameter gold wire wedge bonding is to be preferred.

Recommended circuit bonding table

Label	Type	Decoupling	Comment
RF OUT	RF	Not required	VCO output port
VC	Vc	120pF & 100nF & 2.2µF	Collector Supply
VT	VT	100nF & 2.2µF	Varactor Supply

Evaluation mother board

- Based on typically Ro4003 / 8mils or equivalent.
- Decoupling capacitors of 120nF, 100nF $\pm 10\%$ and 2.2 μ F $\pm 10\%$ are recommended for all DC accesses.

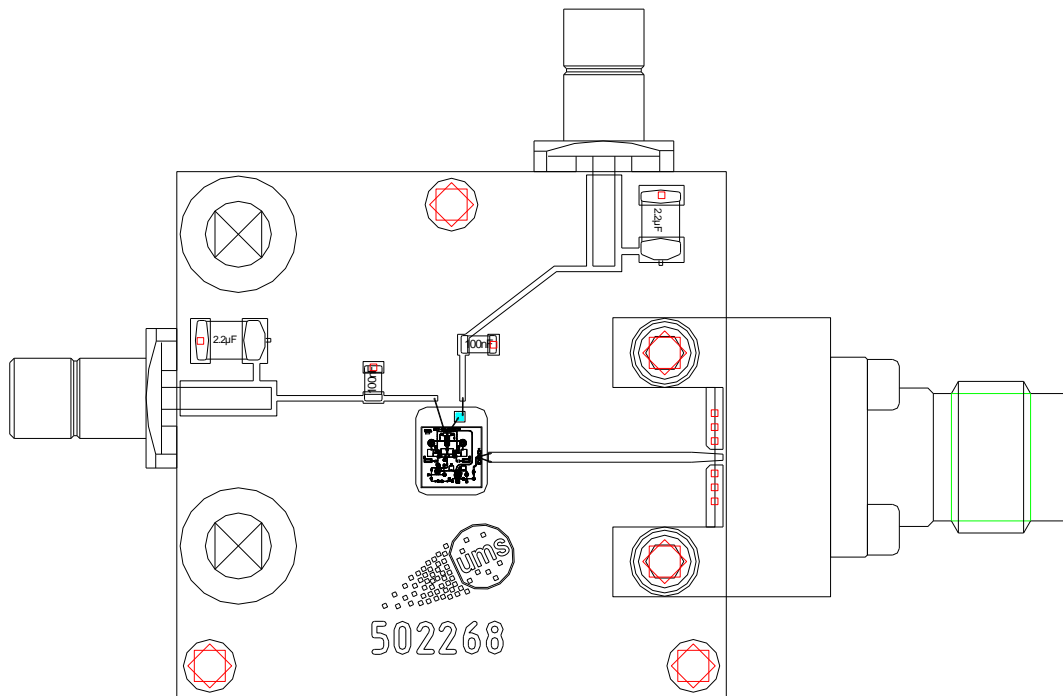

Recommended ESD management

Refer to the application note AN0020 available at <http://www.ums-gaas.com> for ESD sensitivity and handling recommendations for the UMS products.

Recommended environmental management

UMS products are compliant with the regulation in particular with the directives RoHS N°2011/65 and REACH N°1907/2006. More environmental data are available in the application note AN0019 also available at <http://www.ums-gaas.com>.

Ordering Information

Chip form:

CHV1206a98F/00

Information furnished is believed to be accurate and reliable. However **United Monolithic Semiconductors S.A.S.** assumes no responsibility for the consequences of use of such information nor for any infringement of patents or other rights of third parties which may result from its use. No license is granted by implication or otherwise under any patent or patent rights of **United Monolithic Semiconductors S.A.S.** Specifications mentioned in this publication are subject to change without notice. This publication supersedes and replaces all information previously supplied. **United Monolithic Semiconductors S.A.S.** products are not authorised for use as critical components in life support devices or systems without express written approval from **United Monolithic Semiconductors S.A.S.**