



COAXIAL SOLID-STATE

High Power Signal Source

RFS-2G42G51K0+

50 Ω 1000 W 2.4 to 2.5 GHz

THE BIG DEAL

- High output power, 1000W
- 2.4 to 2.5GHz ISM band
- Suitable for CW and pulsed signals
- High gain, 53 dB typical
- High ruggedness
- Built-in monitoring and protection for temperature, current, forward, and reflected power
- High Power 7/16" connector located on the backside of the unit for RF power delivery
- Includes signal generation and control
- User-friendly, integrated touchscreen interface
- USB, RS232, and Modbus TCP compatible
- Optional EtherCAT interface available
- Can operate as a stand-alone amplifier
- Integrated low-voltage power supply
- Water cooled (no moving fans inside)
- Compact 2U 19" rackmount kit



Generic photo used for illustration purposes only

APPLICATIONS

The RFS-2G42G51K0+ module can be used stand-alone or as a building block in any single or multi-channel system for high-power RF Energy applications such as:

- Materials processing
- Food processing (heating, tempering, and pasteurization)
- Microwave-assisted chemistry
- Plasma generation
- Plasma surface treatment
- Disinfection/Sterilization
- Chemistry
- Semiconductor RF generators

PRODUCT OVERVIEW

The RFS-2G42G51K0+ is a new generation solid-state connectorized rack-mount high-power amplifier with an integrated signal source, capable of supporting both CW and pulsed applications. The unit can be used in a wide range of industrial, scientific, and medical applications in the 2400-2500 MHz ISM band. The compact water-cooled system is built around four Mini-Circuits ZHL-2425-250X+ 250W pallets. The amplifier features built-in protection for temperature, current, forward power, and reverse power. USB, Ethernet, EtherCAT, and RS-485 interfaces are available. A Windows-based GUI provides access to the signal/PWM source as well as monitoring functions. A front-panel touchscreen shows the amplifier status and allows the user to configure and control the device. Internal AC to DC power supplies provide the power for the unit.

The high-power signal source (or amplifier when configured as such) has internal shutdown circuitry and integrated protection functions for added reliability under difficult operating conditions, making it virtually impossible to damage. The basic high-power signal source can be controlled externally through a user-friendly USB interface to monitor forward and reflected power to support dynamic load analysis, temperature monitoring, current monitoring, shutdown alarms, enable/disable the signal source/amplifier, and resetting protection alarms.





COAXIAL SOLID-STATE

High Power Signal Source

RFS-2G42G51K0+

50 Ω 1000 W 2.4 to 2.5 GHz

KEY FEATURES

Features	Advantages
High CW Power	Supports high-power applications for a wide range of industrial, scientific, and medical applications in the 2400 – 2500 MHz ISM frequency band. Power can be regulated accurately from 1W up to 1kW @+25C.
High Gain	When operated as a standalone amplifier, the typical gain is 56dB. The RFS-2G42G51K0+ can be driven to full output power with commercially available integrated signal generators.
High Efficiency	The RFS-2G42G51K0+ uses high-efficiency state-of-the-art LDMOS technology. This combined with adaptive frequency control enables maximum conversion efficiency in the application.
Built-in protection	The RFS-2G42G51K0+ has built-in monitoring and protection for temperature, voltage, current, forward power, reverse power, and internal shutdown circuitry for added reliability under difficult operating conditions. When the prestored limits shown in the protection limits table are exceeded the signal source/amplifier will shut down.
Built-in signal generation	Versatile and flexible small signal RF generator specifically designed to control RF Energy applications in the 2400 - 2500 MHz band.
Ruggedness	The RFS-2G42G51K0+ has excellent reverse isolation and ruggedness with onboard circulators. Reverse power is monitored, and the signal source/amplifiers are shut down when the reverse power exceeds the prestored limits shown in the protection limits table.
Forward & Reverse Power Detection	The RFS-2G42G51K0+ features integrated couplers and detectors for Forward (FWD) and Reflected (REFL) power detection. FWD and REFL power detection supports reproducible RF power measurements as well as dynamic load analysis and can be used to control or shut off the signal source/amplifier by using internal monitoring or an external controller.
Easy interfacing	Easy access to the RFS-2G42G51K0+ through USB or UART interface, enabling dynamic ISM applications with either single or multiple modules to be controlled. The front panel touchscreen interface provides easy access to all the basic functions and operating modes. Digital inputs and outputs (RS-232, RS-485, USB) permit low-level interfacing to the unit to minimize manual control overhead.
Low Profile 2U 19" Rack	With a small footprint and 19" 2U, lightweight 17kg the modular design is flexible for single or multiple system integration.
Cooling	The RFS-2G42G51K0+ must be water cooled by a continuous flow of water (flow rate 4Liter/min at 10PSI) through the DN6 Snap-on water connector hookups available on the module back panel. The DN6 hose-type connectors have a valve inside that shuts the water flow when it is disconnected.
AC Supply Voltage	The RFS-2G42G51K0+ is powered by a single-phase 185-265V 50-60Hz AC Supply rated for 20A.
GUI	Module supported by a dedicated GUI Accessible through the front panel touch screen interface or external Windows PC through front panel USB connection. Supports user-designed application-level software. A comprehensive programming manual for the RF generator is provided.





COAXIAL SOLID-STATE

High Power Signal Source

RFS-2G42G51K0+

50 Ω 1000 W 2.4 to 2.5 GHz

GENERAL ELECTRICAL SPECIFICATIONS AT $T_{WATER} = +20^{\circ}\text{C}$ (FLOW RATE 4 L/MIN), 50Ω SYSTEM

Parameter	Symbol	Conditions	Min.	Typ.	Max.	Units
Frequency Range	f		2400	—	2500	MHz
Saturated Output Power	P_{SAT}	f=2400 MHz to 2500 MHz	950	1000		Watts
			59.8	60		dBm
AC Supply Frequency			47	50-60	63	Hz
AC Supply Voltage	V_{AC}	f=2400 MHz to 2500 MHz	185	200-240	264	V
AC Supply Current	I_{AC}	f=2400 MHz to 2500 MHz @0dB Atten. setting and 60dBm P_{OUT}	—	10	16	A

HIGH POWER SIGNAL SOURCE ELECTRICAL SPECIFICATIONS AT $T_{WATER} = +20^{\circ}\text{C}$ (FLOW RATE 4 L/MIN), 50Ω SYSTEM

Parameter	Symbol	Conditions	Min.	Typ.	Max.	Units
Frequency Resolution	f_{RES}	f=2400 MHz to 2500 MHz	—	1	—	MHz
Output Power Control Range	P_{OUT_CTRL}	f=2400 MHz to 2500 MHz		30		dB
Output Power Control Resolution	P_{OUT_RES}	f=2400 MHz to 2500 MHz	—	0.1	—	dB
Output Power Meas. Resolution	$P_{OUT_MEAS_RES}$	f=2400 MHz to 2500 MHz	—	0.2	—	dB
Phase Range	θ	f=2400 MHz to 2500 MHz	—	360	—	Deg
Phase Resolution	θ_{RES}	f=2400 MHz to 2500 MHz		1		Deg
PWM Duty Cycle ⁴	DC_{PWM}	f=2400 MHz to 2500 MHz	1	—	99	%
PWM Frequency ⁴	PWM	f=2400 MHz to 2500 MHz	1	—	19.5	kHz

STAND-ALONE HIGH POWER AMPLIFIER ELECTRICAL SPECIFICATIONS AT $T_{WATER} = +20^{\circ}\text{C}$ (FLOW RATE 4 L/MIN), 50Ω SYSTEM

Parameter	Symbol	Conditions	Min.	Typ.	Max.	Units
Input Power	P_{IN}	f=2400 MHz to 2500 MHz @59.8dBm P_{OUT}	—	6.3	15	dBm
Power Gain	G_P	f=2400 MHz to 2500 MHz @ 57dBm P_{OUT}	—	53.5	—	dB
Power Gain Flatness	G_{FLAT}	f=2400 MHz to 2500 MHz @ 57dBm P_{OUT}	—	—	±1	dB
Input VSWR	I_{VSWR}	f=2400 MHz to 2500 MHz	—	1.5	2.5	:1

PROTECTION LIMITS

Parameter	Symbol	Min.	Max.	Units
Temperature Sense ³	T_{sense}	0	65	°C
Reverse Power	P_{REV}	—	800	Watts
		—	59.0	dBm

ABSOLUTE MAXIMUM RATINGS²

Parameter	Ratings
Operating Temperature ³	0°C to +65°C
Storage Temperature	-20°C to +85°C
Input RF Power	+13.5 dBm
Reverse Power at RF output port	800 W
	59.0 dBm

- To ensure accurate power readings (and therefore accurate power output), the minimum value of the duty cycle changes along with the PWM frequency. See the PWM section for more details.
- RFS-2G42G51K0+ may operate up to these maximum ratings limits with no damage, permanent damage may occur if any of these limits are exceeded.
- This is the sensed temperature (T_{sense}) shown on the front panel or read through the remote interface from the RFS-2G42G51K0+. This temperature is the max sensed temperature of the four internal ZHL-2G42G5- 250X+ amplifiers. The Maximum recommended Water temperature at a flow rate of 4L/min at 1KW output power is 50°C.
- $DC_{PWM}(\text{min}) = f_{PWM} * \text{tpulse}(\text{min})$; $\text{tpulse}(\text{min}) = 50\mu\text{s}$.





COAXIAL SOLID-STATE

High Power Signal Source

RFS-2G42G51K0+

50 Ω 1000 W 2.4 to 2.5 GHz

TYPICAL PERFORMANCE DATA IN POWER AMPLIFIER MODE $T_{WATER} = +20^{\circ}C$ (FLOW RATE 4 L/MIN), 50Ω SYSTEM



The RFS-2G42G51K0 is set to amplifier mode in the GUI. This is the AM-AM curve as a result of an external CW input.

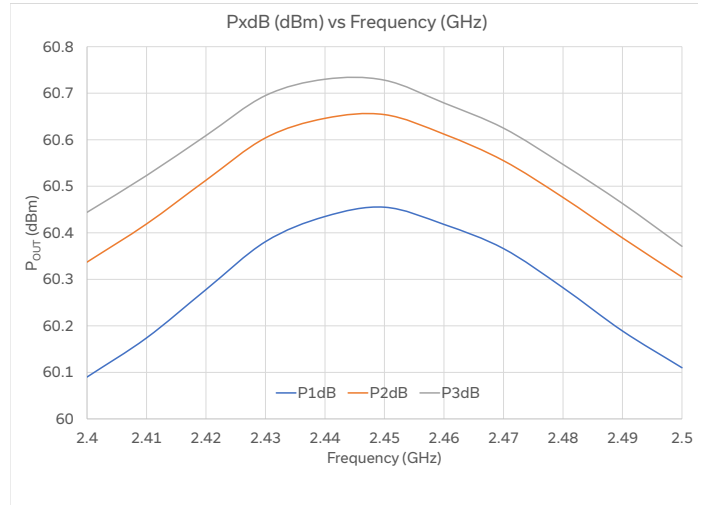

The RFS-2G42G51K0 is set to amplifier mode in the GUI. This is the output power at a compression point referenced to the maximum gain recorded for the given frequency

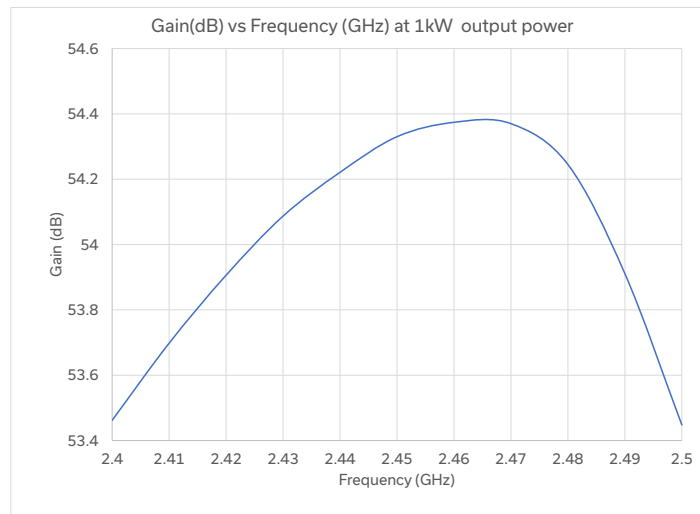

The RFS-2G42G51K0 is set to amplifier mode in the GUI. This is the graph of the gain at a fixed output power of 1KW.



COAXIAL SOLID-STATE

High Power Signal Source

RFS-2G42G51K0+

50 Ω 1000 W 2.4 to 2.5 GHz

TYPICAL PERFORMANCE DATA IN AUTO GAIN MODE $T_{WATER} = +20^{\circ}C$ (FLOW RATE 4 L/MIN), 50Ω SYSTEM



The RFS-2G42G51K0 is set to Normal Mode in the GUI. This is the error recorded in dB of the power measured by an external power meter to the power that was requested on the GUI front panel.

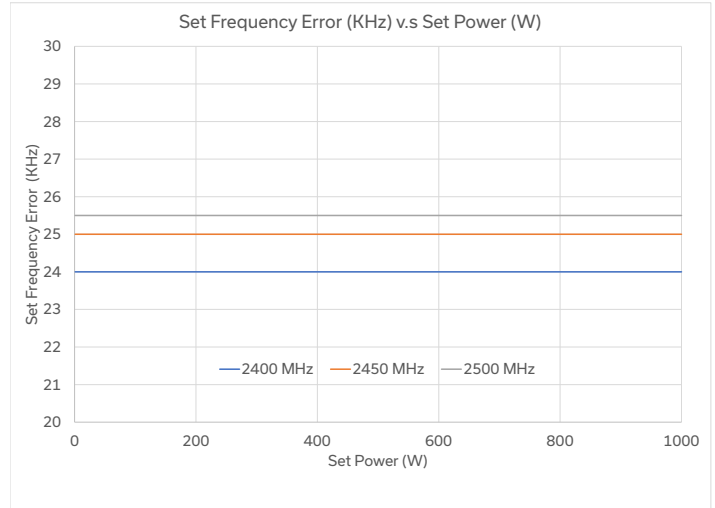

The RFS-2G42G51K0 is set to Normal Mode in the GUI. This is the error recorded in kHz of the Frequency measured by an external spectrum analyzer to the frequency that was requested on the GUI front panel.

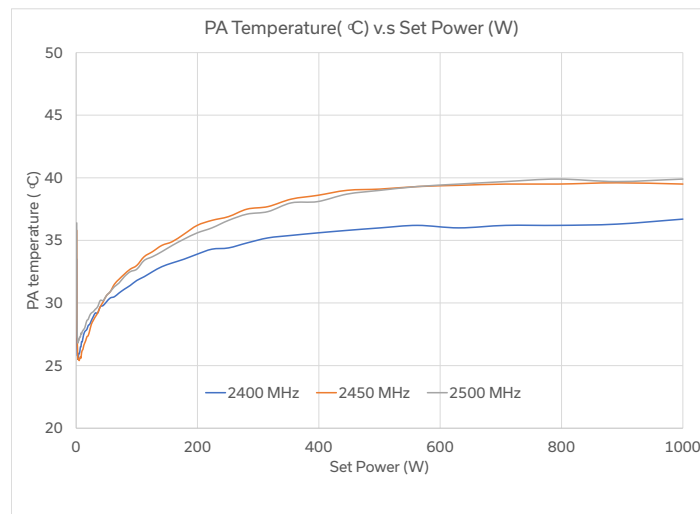

The RFS-2G42G51K0 is set to Normal Mode in the GUI. This is the maximum temperature recorded on the internal power amplifiers. Each power set point is dwelled approximately 2 seconds for the power measurement. The water temperature was set to 24°C with a flow rate of 4L/min



COAXIAL SOLID-STATE

High Power Signal Source

RFS-2G42G51K0+

Mini-Circuits

50 Ω 1000 W 2.4 to 2.5 GHz

TYPICAL PERFORMANCE DATA ACROSS FREQUENCY IN FEED FORWARD MODE $T_{WATER} = +20^{\circ}C$ (FLOW RATE 4 L/MIN), 50Ω SYSTEM

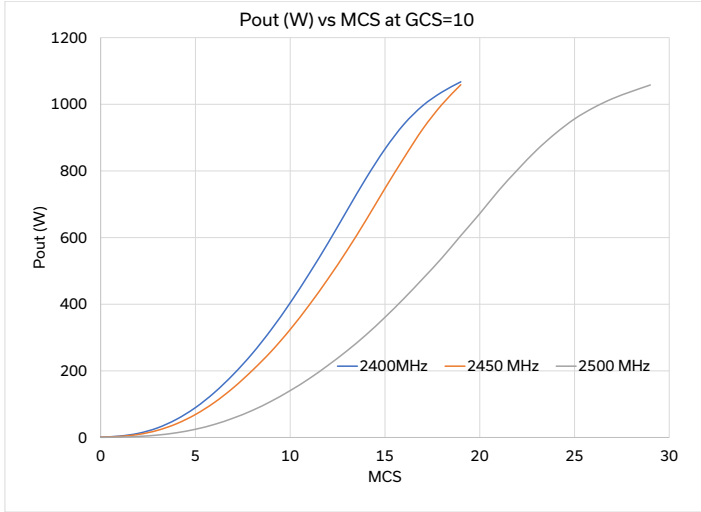

The RFS-2G42G51K0 is set to FeedForward mode in the GUI. The GCS value is set to 10dB and the MCS value is varied until 1KW is achieved. GCS is a coarse attenuator value and the MCS setting is a higher resolution output of an RF modulator

The RFS-2G42G51K0 is set to FeedForward mode in the GUI. The GCS value is set to 15dB and the MCS value is varied until 1KW is achieved. GCS is a coarse attenuator value and the MCS setting is a higher resolution output of an RF modulator

TYPICAL PERFORMANCE DATA ACROSS FREQUENCY IN FEED FORWARD MODE WITH OUTPUT POWER SET TO 1KW ($T_{WATER} = +20^{\circ}C$, 50Ω SYSTEM)

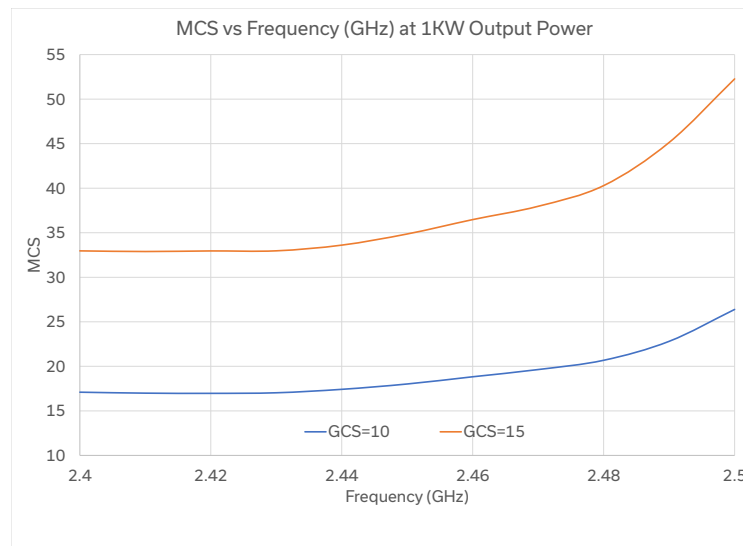

The RFS-2G42G51K0 is set to FeedForward mode in the GUI. This shows the MCS setting required at a given GCS value to get 1KW output



BLOCK DIAGRAM

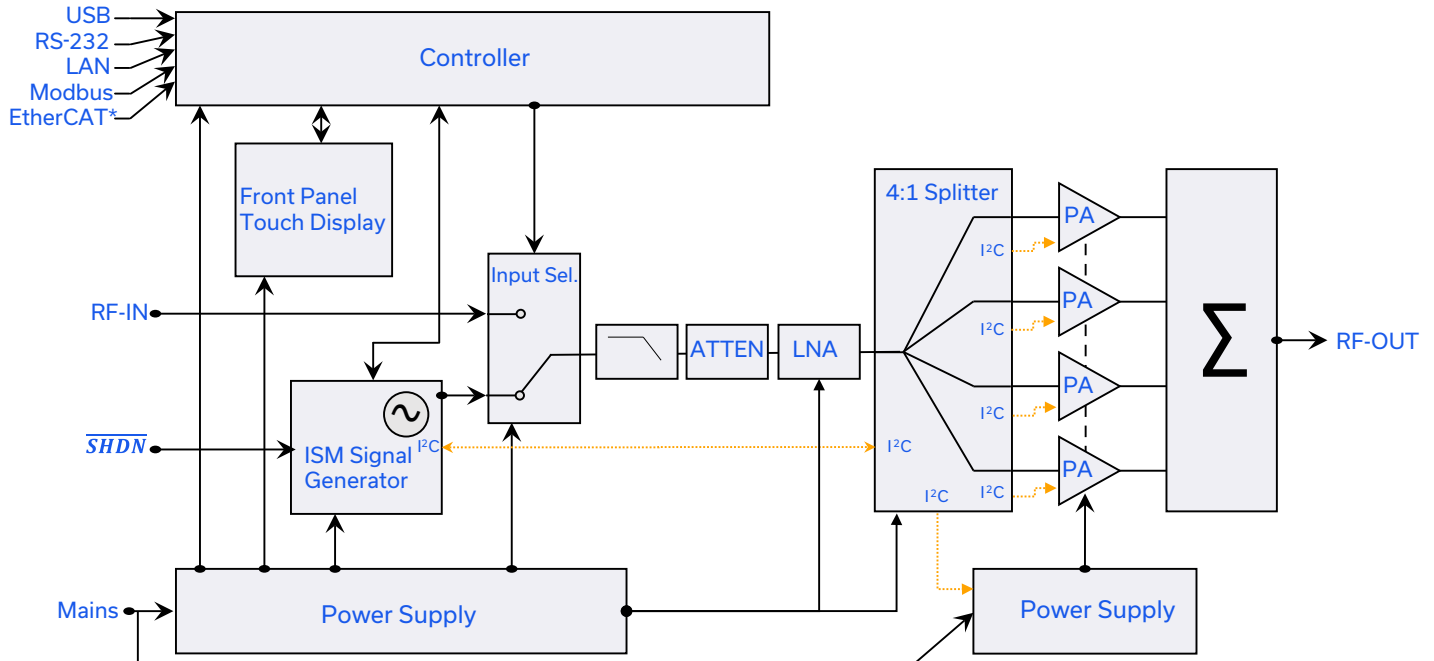

* Optional interfaces available upon request

COOLING REQUIREMENTS

The RFS-2G42G51K0+ must be cooled with a continuous flow of water (flow rate 12 Liter/min at 10PSI) through the DN6 Snap-on water connector hookups available on the module back panel. The DN6 hose-type connectors have a valve inside that shuts the water flow when it is disconnected.

APPLICATION OVERVIEW

The RFS-2G42G51K0+ can operate as a standalone RF power generator or as a stand-alone amplifier. The high-power signal source is ready to deliver RF power to any applicator, i.e., a "device" to contain and/or apply the RF energy. The use of the latest generation solid-state technology guarantees a fully controllable and stable output power along with high efficiency and a long lifetime in a compact module outline. The module has built-in monitoring and protection for temperature, current, forward power, reverse power, and internal shutdown circuitry for added reliability under difficult operating conditions, making it virtually impossible to destroy in single and multi-channel systems due to the integrated circulator and protection functions. When the prestored limits shown in the protection limits table are exceeded, the module will shut down and remain disabled until the conditions return to nominal and an alarm reset command is sent. Users may consult the factory for more in-depth control commands and protection overrides available in advanced operating modes. The RFS-2G42G51K0+ can operate in both CW and PWM modes.



COAXIAL SOLID-STATE

High Power Signal Source

RFS-2G42G51K0+

50 Ω 1000 W 2.4 to 2.5 GHz

FRONT PANEL



FRONT PANEL INTERFACES

Port Name	Interface Type	Description	Connector Type
USB (Front Panel)	Digital I/O Connector	The front panel USB interface for connecting a keyboard, mouse, or Remote Control.	USB-A Female
POWER	Push Button	Switches on and off the voltage to the internal RF power amplifiers	N/A
SCREEN	Touch Display	Front panel touch screen for monitoring and control	N/A

POWER BUTTON FUNCTION/ILLUMINATION

Port Name	Interface Type	Description
No Illumination	ZHL amplifiers off	DC Voltage OFF
Solid White	RF Power on	ZHL DC V ON
Fast Blink (500msec)	RF Power off - error reported	ZHL DC V ON
Slow Blink (1000msec)	Remote command mode (RF could be on or off)	ZHL DC V ON



COAXIAL SOLID-STATE

High Power Signal Source

RFS-2G42G51K0+

50 Ω 1000 W 2.4 to 2.5 GHz

BACK PANEL



BACK PANEL INTERFACES

Port Name	Interface Type	Description	Connector Type
USB (Back-Panel)	Digital I/O Connector	The front panel USB interface for connecting a keyboard, mouse, or Remote Control.	USB-A Female
J1	Digital I/O Connector	Digital I/O for RS-232 and RS-485/422 communication	M12 Female, A Code, 12 pin
J2	Digital I/O Connector	Ethernet	M12 Female, D code, 4 Pin
J3	Digital I/O Connector	Blank	
J4	RF connector	10MHz reference configurable (IN/OUT)	BNC Female
J5	RF connector	Blank	
J6	RF connector	Analog disable RF	BNC Female
RF IN	RF Connector	RF input for use in stand-alone amplifier mode	SMA Female
RF OUT	RF Connector	RF Output 1kW	7/16 Female
WATER IN, WATER OUT	Hydraulic Hose Fitting	Input and Output for water cooling	3/8" Snap-tite H series brass nipple, valved
Line In	AC Power Receptacle	185-264V, 20A, AC Line Input	C20
Line Switch	Rocker Switch	Switch for AC Line In	N/A

J1 PIN OUT

Port Name	Interface Type	Description
1	RS 232	RTS_232
2	RS 232	CTS_232
3	-	Reserved
4	RS 232	TXD_232
5	-	Reserved
6	-	Reserved
7	-	Reserved
8	RS 232	RX_232
9	RS 232	GND
10	RS 232	GND
11	NC	NC
12	NC	NC





COAXIAL SOLID-STATE

High Power Signal Source

RFS-2G42G51K0+

50 Ω 1000 W 2.4 to 2.5 GHz

GRAPHICAL USER INTERFACE (GUI) KEY FEATURES

- Full Control of signal source
- Set Frequency
- Set power
- Configure generator state at power-up
- Track real-time optimum S11 frequency (Digital Locked Loop -DLL)
- Configure CW & Pulse width modulation
- Forward and reflected power tracking in real-time
- Switch between internal and external signal source

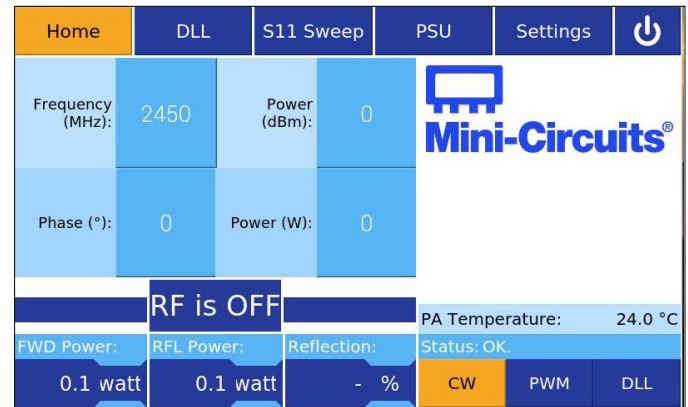

SOFTWARE & DOCUMENTATION DOWNLOAD:

Full software support is provided, including a user-friendly GUI application, a comprehensive application programmer interface (API), and programming instructions for both Windows and Linux environments. The latest version of the full software package can be downloaded from www.minicircuits.com/softwaredownload/RFEnergy-software_download.html.

APPLICATION PROGRAMMING INTERFACE (API) SUPPORT

The application programmer's interface (API) is implemented through a plain-text command language.

REMOTE CONTROL

The RFS-2G42G51K0+ supports USB, RS232, and RS485-based communication. Once the module is connected to a Windows™ or Linux™ computer, the generator will appear as a virtual com-port and be usable as a UART (universal asynchronous receive and transmit interface). The remote command library is extensive and is available in a programming manual that is found on the Mini-Circuits website under the product dashboard.

SIGNAL SOURCE

When the RFS-2G42G51K0+ is powered ON, the GUI will open and the default configuration will be as a signal source with the input select switch set to the internal VCO, VCO off, Freq. 2450MHz, the internal attenuator set to 31.75dB, and PA Enable OFF. Through the Graphical USER Interface (GUI) application the frequency and output power can be set, an S11 sweep can be performed to find the frequency with the minimum reflected power from the applicator, and the DLL function can be used to locate and track the minimum reflected power point. Further support documentation and application notes can be found on the Mini-Circuits website under the product dashboard.

10 MHZ REFERENCE

The 10MHz reference is configurable to be either input or output. In either condition, the voltages are recommended to be in the range of 0.6-2.5 VPP when all components are connected. If the unit falls out of this range the Modulator can fail to operate correctly.

STAND-ALONE POWER AMPLIFIER

The module can be configured as a stand-alone power amplifier using the front panel or remote commands which sets the input select switch to the external RF input and enables the PA. Amplifier status is shown on the front panel and can be read using the commands described in the Programming Manual.





COAXIAL SOLID-STATE

High Power Signal Source

RFS-2G42G51K0+

Mini-Circuits

50 Ω 1000 W 2.4 to 2.5 GHz

OUTLINE DRAWING

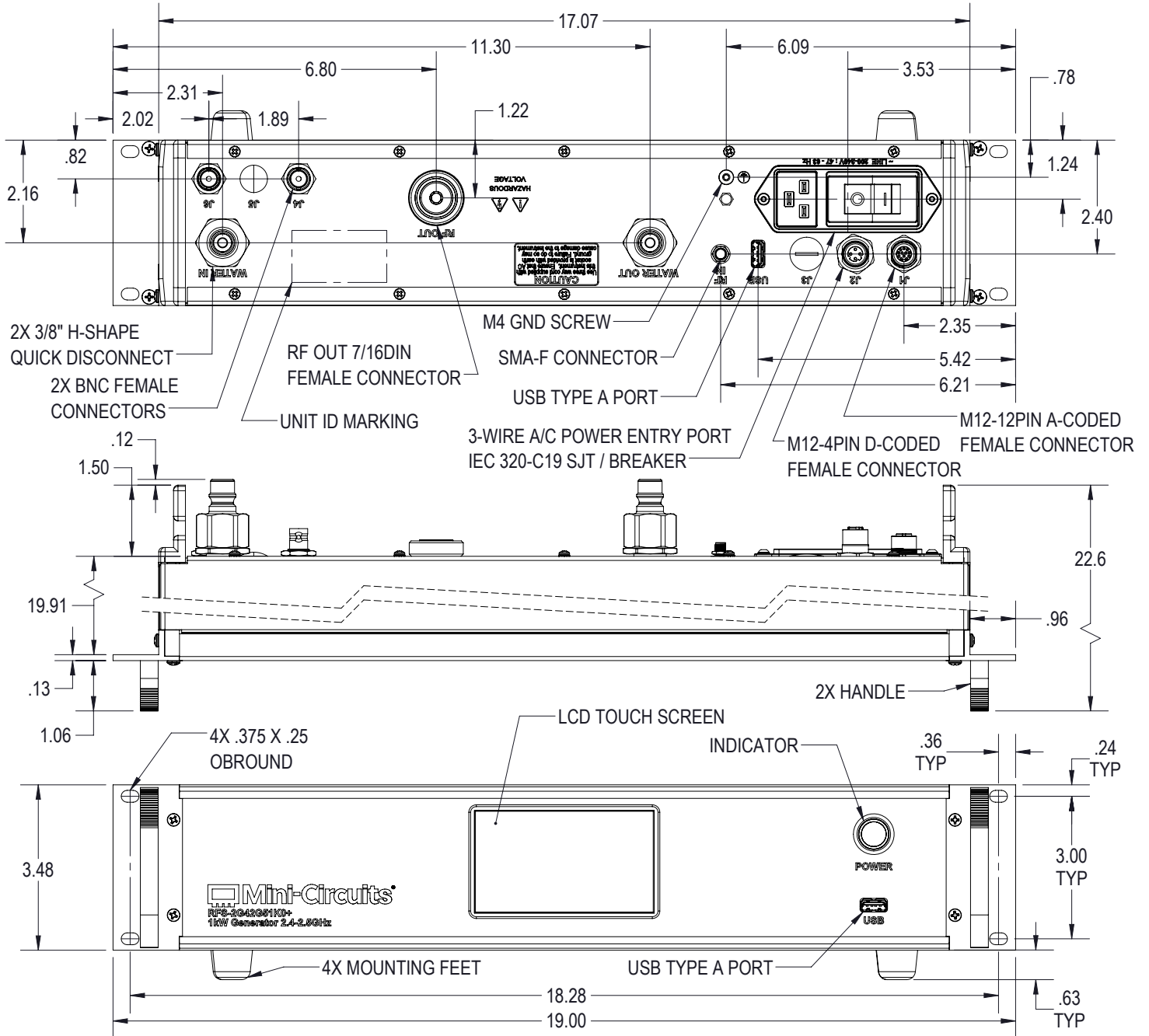

WEIGHT: 17.01 KG

DIMENSIONS ARE IN INCHES. TOLERANCES: 2 PL. ±0.03 INCH, 3 PL. ±0.015 INCH









COAXIAL SOLID-STATE

High Power Signal Source

RFS-2G42G51K0+





50 Ω 1000 W 2.4 to 2.5 GHz

INCLUDED ACCESSORIES (SELECT AT CHECK OUT)

Product Image	Part Number	Description	Quantity
	B47-0131-1	10.00' (3.05m) Power Cord Black NEMA L6-20P To IEC 320-C19 SJT	1*
	B47-0182	EU-Power Cord, C19 to CEE7/7 Male Plug Heavy-Duty, 16A, 250V, 14 AWG, 10 ft. (3 m)	1*
	B47-0184	Israel-Power Cord, C19 to SI32 Male Plug Heavy-Duty, 16A, 250V, 14 AWG, 10 ft. (3 m)	1*
	B47-0185	China-Power Cord, C19 to GB2099 Male Plug Heavy-Duty, 16A, 250V, 14 AWG, 10 ft. (3 m)	1*

* Cable Plug Style can be selected at checkout. Only one of the above-listed options will be included with the order

RECOMMENDED ACCESSORIES

Port Name	Mate Part Number	Manufacturer	Description	Connector Type
Power Cable	70620NC	Grainger	Locking Connector: L6-20R, 20 A, 250V AC, 2 Poles, Black/White, Screw Terminals, L6-20	
Water IN / Water OUT	BVHC6-6M	SNAP-TITE	Hydraulic Quick Connect Hose Coupling: 3/8 in Coupling Size, Brass, 3/8"-18 Thread Size	
J1	1430145	Phoenix Contact	Sensor Cables/Actuator Cables SAC-12P- 5 0-35T FS SH SCO	
J2	TRG506-T4T-05M	L-COM	M12 Female, D code, 4 Pin	





COAXIAL SOLID-STATE

High Power Signal Source

RFS-2G42G51K0+

50 Ω 1000 W 2.4 to 2.5 GHz

ADDITIONAL INFORMATION IS AVAILABLE ON OUR DASHBOARD.

Performance Data & Graphs	Data Graphs
RoHS Status	Compliant
Environmental Ratings	ENV23T33
Export Information	ECCN# EAR99

ORDERING INFORMATION

Model No. Links	RFS-2G42G51K0+
Product Marking	RFS-2G42G51K0+
Case Style	VU3555
Connector	MCX to SMA-Female



Mini-Circuits

COAXIAL SOLID-STATE

High Power Signal Source

RFS-2G42G51K0+

50 Ω 1000 W 2.4 to 2.5 GHz

SAFETY INSTRUCTIONS.

WARNING: FAILURE TO FOLLOW THESE INSTRUCTIONS MAY RESULT IN BODILY INJURY, DEATH, OR PROPERTY DAMAGE.

For your own safety, this section provides instructions for avoiding potential dangers when using this product.

QUALIFIED PERSONNEL

This product should be operated by qualified personnel only. Qualified personnel are individuals who are familiar with the operation of the product and the hazards involved with such operation.

DAMAGED OR MISSING HARDWARE

Do not operate the product if there is physical damage or hardware is missing.

MAXIMUM RATINGS

The maximum ratings in this data sheet should never be exceeded. Stress above one or more maximum ratings may cause permanent damage to the product and may permanently and irreversibly affect the quality and reliability of the product, which may increase the risk of bodily injury, death, or property damage.

HAZARDOUS RF VOLTAGES

The RF voltages inside the product and on the center pin of the RF output connector can be hazardous. Contact with the internal components of the product or the center pin of the RF output connector may lead to burns or electrical shock. Disconnect power before removing the protective cover from the product. Note that removing the protective cover from the product will void the express warranty specified in Mini-Circuits Standard Terms.

To reduce the risks presented by these hazards:

1. never operate the product without its protective cover,
2. always connect the RF output connector to a load before the power source is applied to the product, and
3. always place the product in a non-operating condition before disconnecting or connecting the load to the RF output connector.

COOLING

RF Power amplifiers always need proper cooling. Failure to properly cool the product may increase the risk of bodily injury, death, or damage to property or the product.

Some products contain water cooling systems to help cool down the product. If this data sheet indicates that the product contains a water cooling system, proper waterflow as specified in this data sheet is required to keep the temperature of the product within the temperature range that is specified in this data sheet.

Some products also contain built-in protection circuitry designed to shut-off the amplifier at excessive high temperatures or at other excessive operating conditions. Even if this data sheet indicates that the product contains protective circuitry, such protective circuitry is not a substitute for proper handling in accordance with these instructions. Accordingly, do not rely on the protective circuitry to prevent injury or damage to property or the product.

MAINTENANCE CAUTION

Maintenance or repair of the product must only be performed by qualified personnel when the product is in a non-operating condition and disconnected from its power source. Note that performance of maintenance or repairs to the product will void the express warranty specified in Mini-Circuits Standard Terms.

ENVIRONMENTAL CONDITIONS

Unless otherwise stated in this data sheet, this product is designed to be operated under the environmental conditions set forth in this data sheet, as well as the following conditions:

- Indoor use only
- Temperature of 5°C to 40°C (non-condensing)

WARNING SIGNS

In addition to being qualified before operating the product, pay attention to all warning signs and danger symbols. Failure to heed warnings signs and danger symbols, or to follow their associated instructions, may result in bodily injury, death, or property damage.

NOTES

- A. Performance and quality attributes and conditions not expressly stated in this specification document are intended to be excluded and do not form a part of this specification document.
- B. Electrical specifications and performance data contained in this specification document are based on Mini-Circuit's applicable established test performance criteria and measurement instructions.
- C. The parts covered by this specification document are subject to Mini-Circuits standard limited warranty and terms and conditions (collectively, "Standard Terms"); Purchasers of this part are entitled to the rights and benefits contained therein. For a full statement of the standard terms and the exclusive rights and remedies thereunder, please visit Mini-Circuits' website at www.minicircuits.com/terms/viewterm.html

