

## Dual Precision, 17 MHz, Low Noise, CMOS Input Amplifier

Check for Samples: [SM73307](#)

### FEATURES

- Unless Otherwise Noted, Typical Values at  $V_S = 5V$ .
- Renewable Energy Grade
- Input Offset Voltage  $\pm 150 \mu V$  (max)
- Input Bias Current 100 fA
- Input Voltage Noise  $5.8 \text{ nV}/\sqrt{\text{Hz}}$
- Gain Bandwidth Product 17 MHz
- Supply Current 1.30 mA
- Supply Voltage Range 1.8V to 5.5V
- THD+N @  $f = 1 \text{ kHz}$  0.001%
- Operating Temperature Range  $-40^\circ\text{C}$  to  $125^\circ\text{C}$
- Rail-to-rail Output Swing
- 8-Pin VSSOP Package

### APPLICATIONS

- Photovoltaic Electronics
- Active Filters and Buffers
- Sensor Interface Applications
- Transimpedance Amplifiers
- Automotive

### DESCRIPTION

The SM73307 is a dual, low noise, low offset, CMOS input, rail-to-rail output precision amplifier with a high gain bandwidth product. The SM73307 is ideal for a variety of instrumentation applications including solar photovoltaic.

Utilizing a CMOS input stage, the SM73307 achieves an input bias current of 100 fA, an input referred voltage noise of  $5.8 \text{ nV}/\sqrt{\text{Hz}}$ , and an input offset voltage of less than  $\pm 150 \mu V$ . These features make the SM73307 a superior choice for precision applications.

Consuming only 1.30 mA of supply current per channel, the SM73307 offers a high gain bandwidth product of 17 MHz, enabling accurate amplification at high closed loop gains.

The SM73307 has a supply voltage range of 1.8V to 5.5V, which makes it an ideal choice for portable low power applications with low supply voltage requirements.

The SM73307 is built with TI's advanced VIP50 process technology and is offered in an 8-pin VSSOP package.

The SM73307 incorporates enhanced manufacturing and support processes for the photovoltaic and automotive market, including defect detection methodologies. Reliability qualification is compliant with the requirements and temperature grades defined in the Renewable Energy Grade and AEC-Q100 standards.



Please be aware that an important notice concerning availability, standard warranty, and use in critical applications of Texas Instruments semiconductor products and disclaimers thereto appears at the end of this data sheet.

All trademarks are the property of their respective owners.



These devices have limited built-in ESD protection. The leads should be shorted together or the device placed in conductive foam during storage or handling to prevent electrostatic damage to the MOS gates.

### Absolute Maximum Ratings<sup>(1)(2)</sup>

ESD Tolerance <sup>(3)</sup>	Human Body Model	2000V
	Machine Model	200V
	Charge-Device Model	1000V
$V_{IN}$ Differential		±0.3V
Supply Voltage ( $V_S = V^+ - V^-$ )		6.0V
Voltage on Input/Output Pins		$V^+ +0.3V, V^- -0.3V$
Storage Temperature Range		-65°C to 150°C
Junction Temperature <sup>(4)</sup>		+150°C
Soldering Information	Infrared or Convection (20 sec)	235°C
	Wave Soldering Lead Temp. (10 sec)	260°C

- (1) Absolute Maximum Ratings indicate limits beyond which damage to the device may occur. Operating Ratings indicate conditions for which the device is intended to be functional. For specifications and the test conditions, see the Electrical Characteristics Tables.
- (2) If Military/Aerospace specified devices are required, please contact the Texas Instruments Sales Office/ Distributors for availability and specifications.
- (3) Human Body Model, applicable std. MIL-STD-883, Method 3015.7. Machine Model, applicable std. JESD22-A115-A (ESD MM std. of JEDEC) Field-Induced Charge-Device Model, applicable std. JESD22-C101-C (ESD FICDM std. of JEDEC).
- (4) The maximum power dissipation is a function of  $T_{J(MAX)}$ ,  $\theta_{JA}$ . The maximum allowable power dissipation at any ambient temperature is  $P_D = (T_{J(MAX)} - T_A)/\theta_{JA}$ . All numbers apply for packages soldered directly onto a PC Board.

### Operating Ratings<sup>(1)</sup>

Temperature Range <sup>(2)</sup>		-40°C to 125°C
Supply Voltage ( $V_S = V^+ - V^-$ )	$0^\circ\text{C} \leq T_A \leq 125^\circ\text{C}$	1.8V to 5.5V
	$-40^\circ\text{C} \leq T_A \leq 125^\circ\text{C}$	2.0V to 5.5V
Package Thermal Resistance ( $\theta_{JA}$ <sup>(2)</sup> )	8-Pin VSSOP	236°C/W

- (1) Absolute Maximum Ratings indicate limits beyond which damage to the device may occur. Operating Ratings indicate conditions for which the device is intended to be functional. For specifications and the test conditions, see the Electrical Characteristics Tables.
- (2) The maximum power dissipation is a function of  $T_{J(MAX)}$ ,  $\theta_{JA}$ . The maximum allowable power dissipation at any ambient temperature is  $P_D = (T_{J(MAX)} - T_A)/\theta_{JA}$ . All numbers apply for packages soldered directly onto a PC Board.

## 2.5V Electrical Characteristics

Unless otherwise specified, all limits are specified for  $T_A = 25^\circ\text{C}$ ,  $V^+ = 2.5V$ ,  $V^- = 0V$ ,  $V_O = V_{CM} = V^+/2$ . **Boldface** limits apply at the temperature extremes.

Symbol	Parameter	Conditions	Min <sup>(1)</sup>	Typ <sup>(2)</sup>	Max <sup>(1)</sup>	Units	
$V_{OS}$	Input Offset Voltage	$-20^\circ\text{C} \leq T_A \leq 85^\circ\text{C}$		±20	±180 <b>±330</b>	µV	
		$-40^\circ\text{C} \leq T_A \leq 125^\circ\text{C}$		±20	±180 <b>±430</b>		
TC $V_{OS}$	Input Offset Voltage Temperature Drift <sup>(3)(4)</sup>			-1.75	±4	µV/°C	
$I_B$	Input Bias Current	$V_{CM} = 1.0V$ <sup>(5)(4)</sup>	$-40^\circ\text{C} \leq T_A \leq 85^\circ\text{C}$		0.05	1 <b>25</b>	pA
			$-40^\circ\text{C} \leq T_A \leq 125^\circ\text{C}$		0.05	1 <b>100</b>	

- (1) Limits are 100% production tested at 25°C. Limits over the operating temperature range are specified through correlations using the Statistical Quality Control (SQC) method.
- (2) Typical values represent the most likely parametric norm as determined at the time of characterization. Actual typical values may vary over time and will also depend on the application and configuration.
- (3) Offset voltage average drift is determined by dividing the change in  $V_{OS}$  at the temperature extremes by the total temperature change.
- (4) This parameter is specified by design and/or characterization and is not tested in production.
- (5) Positive current corresponds to current flowing into the device.

## 2.5V Electrical Characteristics (continued)

Unless otherwise specified, all limits are specified for  $T_A = 25^\circ\text{C}$ ,  $V^+ = 2.5\text{V}$ ,  $V^- = 0\text{V}$ ,  $V_O = V_{CM} = V^+/2$ . **Boldface** limits apply at the temperature extremes.

Symbol	Parameter	Conditions	Min <sup>(1)</sup>	Typ <sup>(2)</sup>	Max <sup>(1)</sup>	Units
$I_{OS}$	Input Offset Current	$V_{CM} = 1\text{V}^{(4)}$		0.006	<b>0.5</b> <b>50</b>	$\mu\text{A}$
CMRR	Common Mode Rejection Ratio	$0\text{V} \leq V_{CM} \leq 1.4\text{V}$	<b>83</b> <b>80</b>	100		dB
PSRR	Power Supply Rejection Ratio	$2.0\text{V} \leq V^+ \leq 5.5\text{V}$ $V^- = 0\text{V}$ , $V_{CM} = 0$	<b>85</b> <b>80</b>	100		dB
		$1.8\text{V} \leq V^+ \leq 5.5\text{V}$ $V^- = 0\text{V}$ , $V_{CM} = 0$	85	98		
CMVR	Common Mode Voltage Range	CMRR $\geq 80$ dB CMRR $\geq 78$ dB	-0.3 <b>-0.3</b>		1.5 <b>1.5</b>	V
$A_{VOL}$	Open Loop Voltage Gain	$V_O = 0.15$ to $2.2\text{V}$ $R_L = 2\text{ k}\Omega$ to $V^+/2$	<b>84</b> <b>80</b>	92		dB
		$V_O = 0.15$ to $2.2\text{V}$ $R_L = 10\text{ k}\Omega$ to $V^+/2$	90 <b>86</b>	95		
$V_{OUT}$	Output Voltage Swing High	$R_L = 2\text{ k}\Omega$ to $V^+/2$		25	70 <b>77</b>	mV from either rail
		$R_L = 10\text{ k}\Omega$ to $V^+/2$		20	60 <b>66</b>	
	Output Voltage Swing Low	$R_L = 2\text{ k}\Omega$ to $V^+/2$		30	70 <b>73</b>	
		$R_L = 10\text{ k}\Omega$ to $V^+/2$		15	60 <b>62</b>	
$I_{OUT}$	Output Current	Sourcing to $V^-$ $V_{IN} = 200\text{ mV}^{(6)}$	<b>36</b> <b>30</b>	52		mA
		Sinking to $V^+$ $V_{IN} = -200\text{ mV}^{(6)}$	7.5 <b>5.0</b>	15		
$I_S$	Supply Current	Per Channel		1.10	1.50 <b>1.85</b>	mA
SR	Slew Rate	$A_V = +1$ , Rising (10% to 90%)		8.3		$\text{V}/\mu\text{s}$
		$A_V = +1$ , Falling (90% to 10%)		10.3		
GBW	Gain Bandwidth			14		MHz
$e_n$	Input Referred Voltage Noise Density	$f = 400\text{ Hz}$		6.8		$\text{nV}/\sqrt{\text{Hz}}$
		$f = 1\text{ kHz}$		5.8		
$i_n$	Input Referred Current Noise Density	$f = 1\text{ kHz}$		0.01		$\text{pA}/\sqrt{\text{Hz}}$
THD+N	Total Harmonic Distortion + Noise	$f = 1\text{ kHz}$ , $A_V = 1$ , $R_L = 100\text{ k}\Omega$ $V_O = 0.9 V_{PP}$		0.003		%
		$f = 1\text{ kHz}$ , $A_V = 1$ , $R_L = 600\Omega$ $V_O = 0.9 V_{PP}$		0.004		

(6) The short circuit test is a momentary open loop test.

## 5V Electrical Characteristics

Unless otherwise specified, all limits are specified for  $T_A = 25^\circ\text{C}$ ,  $V^+ = 5\text{V}$ ,  $V^- = 0\text{V}$ ,  $V_{\text{CM}} = V^+/2$ . **Boldface** limits apply at the temperature extremes.

Symbol	Parameter	Conditions	Min <sup>(1)</sup>	Typ <sup>(2)</sup>	Max <sup>(1)</sup>	Units
$V_{\text{OS}}$	Input Offset Voltage	$-20^\circ\text{C} \leq T_A \leq 85^\circ\text{C}$		$\pm 10$	$\pm 150$ <b><math>\pm 300</math></b>	$\mu\text{V}$
		$-40^\circ\text{C} \leq T_A \leq 125^\circ\text{C}$		$\pm 10$	$\pm 150$ <b><math>\pm 400</math></b>	
$\text{TC } V_{\text{OS}}$	Input Offset Voltage Temperature Drift <sup>(3)(4)</sup>			-1.75	$\pm 4$	$\mu\text{V}/^\circ\text{C}$
$I_{\text{B}}$	Input Bias Current	$V_{\text{CM}} = 2.0\text{V}^{(5)(4)}$	$-40^\circ\text{C} \leq T_A \leq 85^\circ\text{C}$	0.1	1 <b>25</b>	$\text{pA}$
			$-40^\circ\text{C} \leq T_A \leq 125^\circ\text{C}$	0.1	1 <b>100</b>	
$I_{\text{OS}}$	Input Offset Current	$V_{\text{CM}} = 2.0\text{V}^{(4)}$		0.01	0.5 <b>50</b>	$\text{pA}$
CMRR	Common Mode Rejection Ratio	$0\text{V} \leq V_{\text{CM}} \leq 3.7\text{V}$	85 <b>82</b>	100		$\text{dB}$
PSRR	Power Supply Rejection Ratio	$2.0\text{V} \leq V^+ \leq 5.5\text{V}$ $V^- = 0\text{V}$ , $V_{\text{CM}} = 0$	85 <b>80</b>	100		$\text{dB}$
		$1.8\text{V} \leq V^+ \leq 5.5\text{V}$ $V^- = 0\text{V}$ , $V_{\text{CM}} = 0$	85	98		
CMVR	Common Mode Voltage Range	CMRR $\geq 80\text{ dB}$ CMRR $\geq 78\text{ dB}$	-0.3 <b>-0.3</b>		4 <b>4</b>	$\text{V}$
$A_{\text{VOL}}$	Open Loop Voltage Gain	$V_{\text{O}} = 0.3\text{ to }4.7\text{V}$ $R_{\text{L}} = 2\text{ k}\Omega\text{ to }V^+/2$	84 <b>80</b>	90		$\text{dB}$
		$V_{\text{O}} = 0.3\text{ to }4.7\text{V}$ $R_{\text{L}} = 10\text{ k}\Omega\text{ to }V^+/2$	90 <b>86</b>	95		
$V_{\text{OUT}}$	Output Voltage Swing High	$R_{\text{L}} = 2\text{ k}\Omega\text{ to }V^+/2$		32	70 <b>77</b>	mV from either rail
		$R_{\text{L}} = 10\text{ k}\Omega\text{ to }V^+/2$		22	60 <b>66</b>	
	Output Voltage Swing Low	$R_{\text{L}} = 2\text{ k}\Omega\text{ to }V^+/2$		45	75 <b>78</b>	
		$R_{\text{L}} = 10\text{ k}\Omega\text{ to }V^+/2$		20	60 <b>62</b>	
$I_{\text{OUT}}$	Output Current	Sourcing to $V^-$ $V_{\text{IN}} = 200\text{ mV}^{(6)}$	46 <b>38</b>	66		$\text{mA}$
		Sinking to $V^+$ $V_{\text{IN}} = -200\text{ mV}^{(6)}$	10.5 <b>6.5</b>	23		
$I_{\text{S}}$	Supply Current	(per channel)		1.30	1.70 <b>2.05</b>	$\text{mA}$

- (1) Limits are 100% production tested at  $25^\circ\text{C}$ . Limits over the operating temperature range are specified through correlations using the Statistical Quality Control (SQC) method.
- (2) Typical values represent the most likely parametric norm as determined at the time of characterization. Actual typical values may vary over time and will also depend on the application and configuration.
- (3) Offset voltage average drift is determined by dividing the change in  $V_{\text{OS}}$  at the temperature extremes by the total temperature change.
- (4) This parameter is specified by design and/or characterization and is not tested in production.
- (5) Positive current corresponds to current flowing into the device.
- (6) The short circuit test is a momentary open loop test.

### 5V Electrical Characteristics (continued)

Unless otherwise specified, all limits are specified for  $T_A = 25^\circ\text{C}$ ,  $V^+ = 5\text{V}$ ,  $V^- = 0\text{V}$ ,  $V_{\text{CM}} = V^+/2$ . **Boldface** limits apply at the temperature extremes.

Symbol	Parameter	Conditions	Min <sup>(1)</sup>	Typ <sup>(2)</sup>	Max <sup>(1)</sup>	Units
SR	Slew Rate	$A_V = +1$ , Rising (10% to 90%)	6.0	9.5		$\text{V}/\mu\text{s}$
		$A_V = +1$ , Falling (90% to 10%)	7.5	11.5		
GBW	Gain Bandwidth			17		MHz
$e_n$	Input Referred Voltage Noise Density	$f = 400\text{ Hz}$		7.0		$\text{nV}/\sqrt{\text{Hz}}$
		$f = 1\text{ kHz}$		5.8		
$i_n$	Input Referred Current Noise Density	$f = 1\text{ kHz}$		0.01		$\text{pA}/\sqrt{\text{Hz}}$
THD+N	Total Harmonic Distortion + Noise	$f = 1\text{ kHz}$ , $A_V = 1$ , $R_L = 100\text{ k}\Omega$ $V_O = 4\text{ V}_{\text{PP}}$		0.001		%
		$f = 1\text{ kHz}$ , $A_V = 1$ , $R_L = 600\Omega$ $V_O = 4\text{ V}_{\text{PP}}$		0.004		

### Connection Diagram

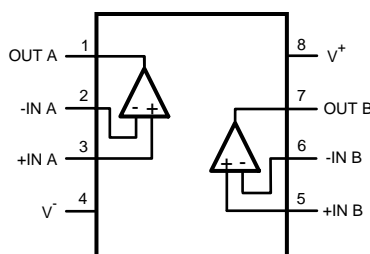

**Figure 1. 8-Pin VSSOP – Top View**  
**See Package Number DGK**

### Typical Performance Characteristics

Unless otherwise noted:  $T_A = 25^\circ\text{C}$ ,  $V_S = 5\text{V}$ ,  $V_{CM} = V_S/2$ .

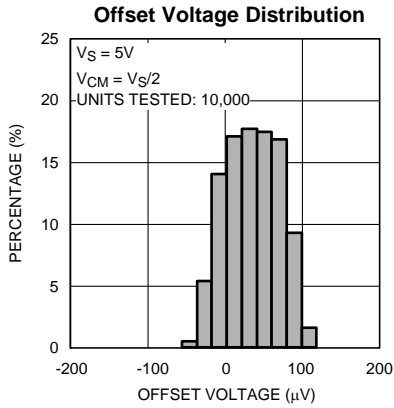

Figure 2.

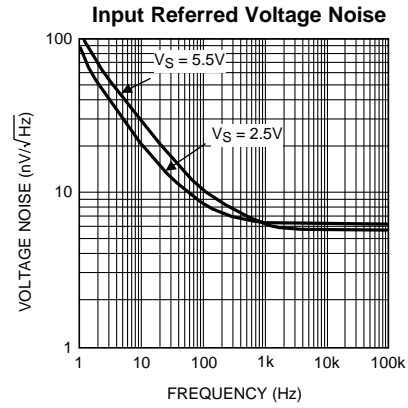

Figure 3.

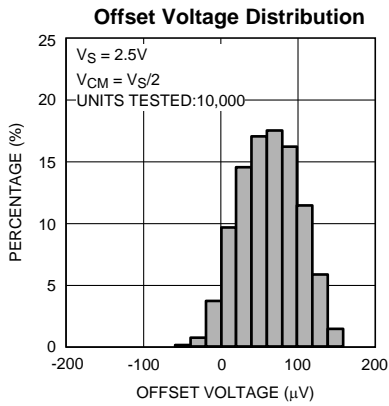

Figure 4.

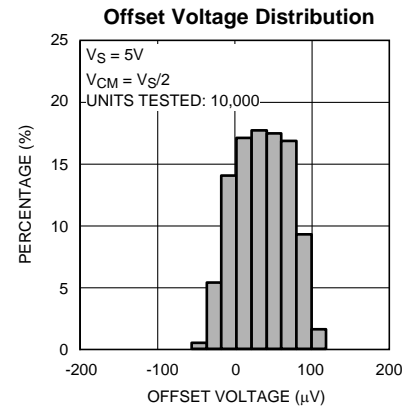

Figure 5.

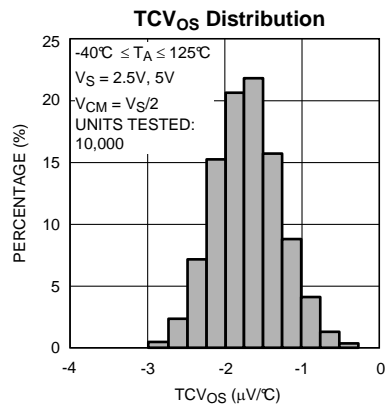

Figure 6.

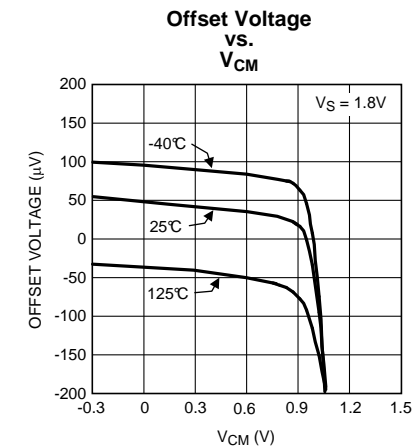

Figure 7.

**Typical Performance Characteristics (continued)**

Unless otherwise noted:  $T_A = 25^\circ\text{C}$ ,  $V_S = 5\text{V}$ ,  $V_{CM} = V_S/2$ .

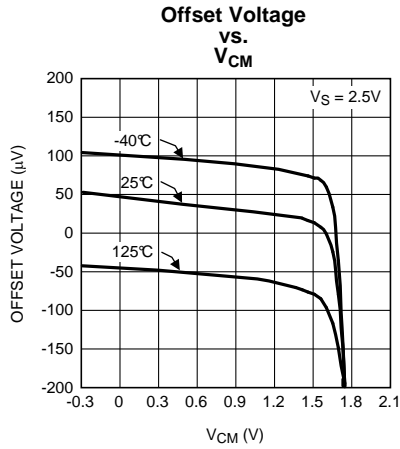

Figure 8.

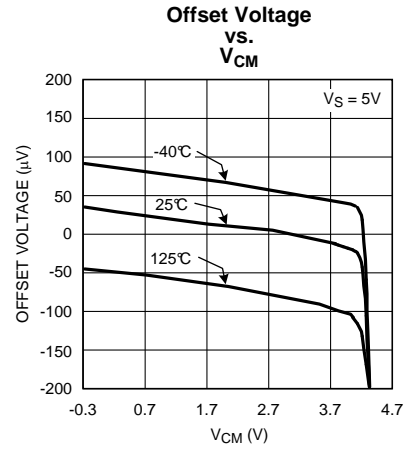

Figure 9.

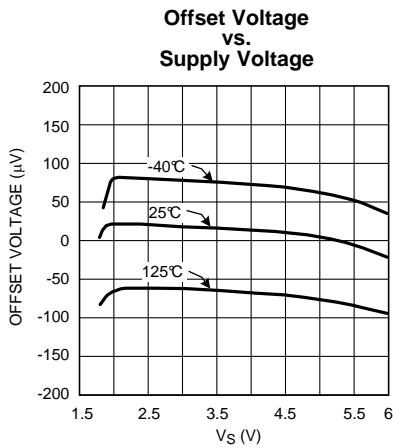

Figure 10.

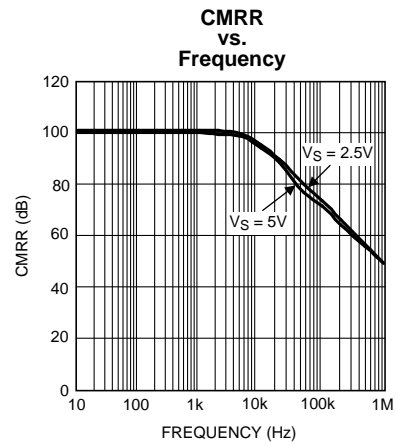

Figure 11.

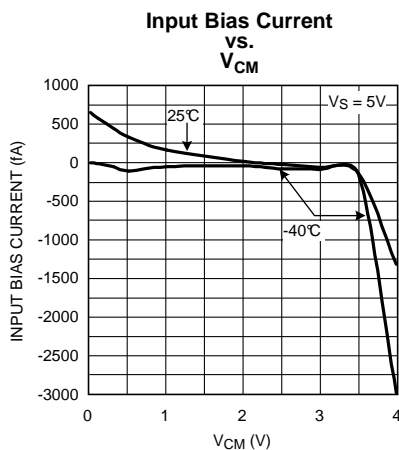

Figure 12.

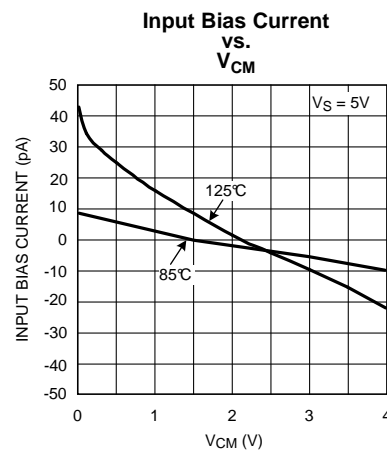

Figure 13.

**Typical Performance Characteristics (continued)**

Unless otherwise noted:  $T_A = 25^\circ\text{C}$ ,  $V_S = 5\text{V}$ ,  $V_{CM} = V_S/2$ .

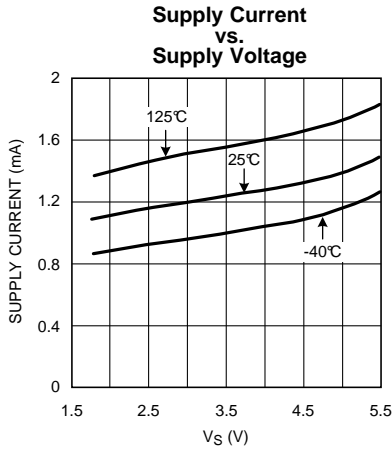

Figure 14.

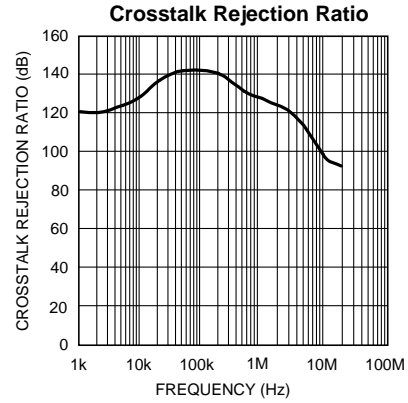

Figure 15.

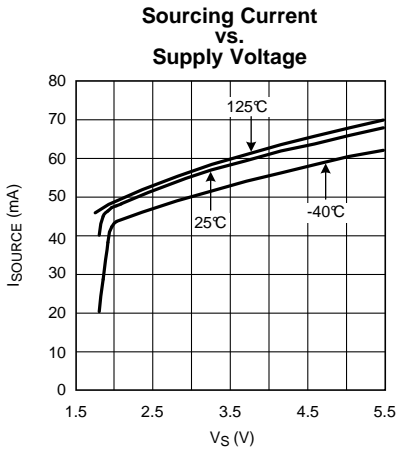

Figure 16.

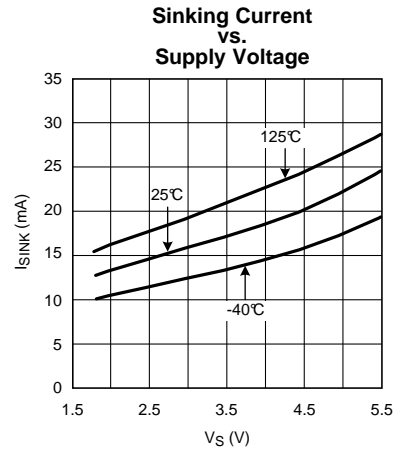

Figure 17.

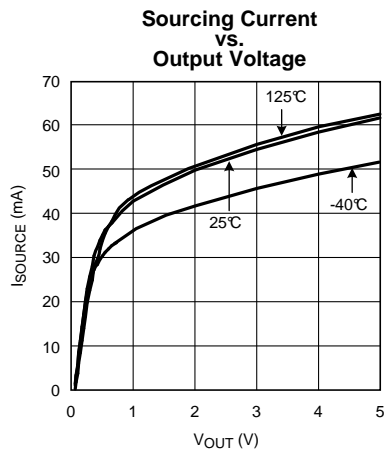

Figure 18.

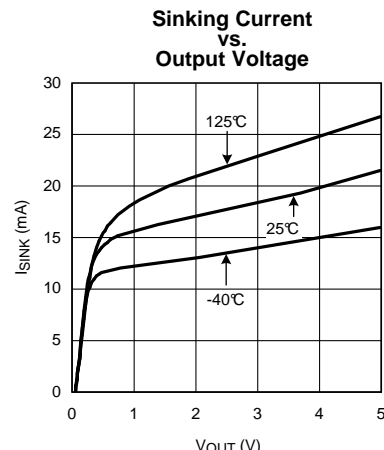

Figure 19.



**Typical Performance Characteristics (continued)**

Unless otherwise noted:  $T_A = 25^\circ\text{C}$ ,  $V_S = 5\text{V}$ ,  $V_{CM} = V_S/2$ .

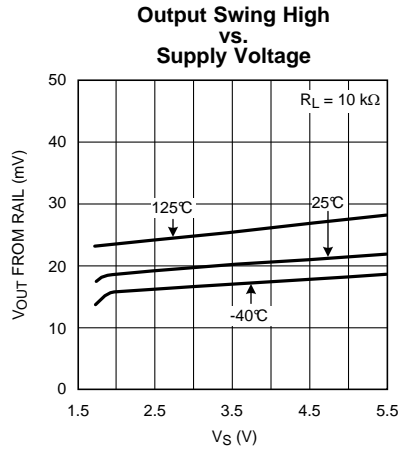

Figure 20.

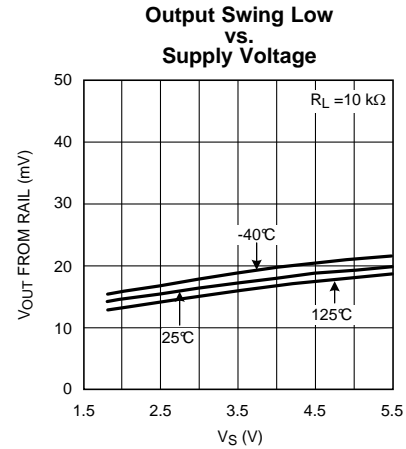

Figure 21.

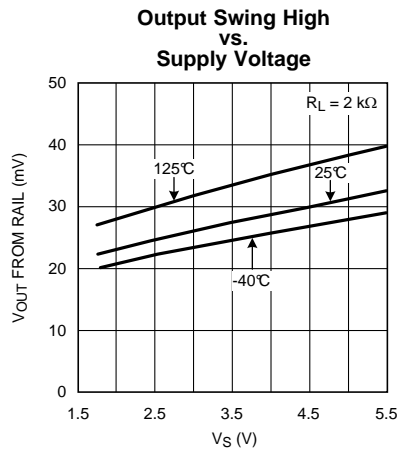

Figure 22.

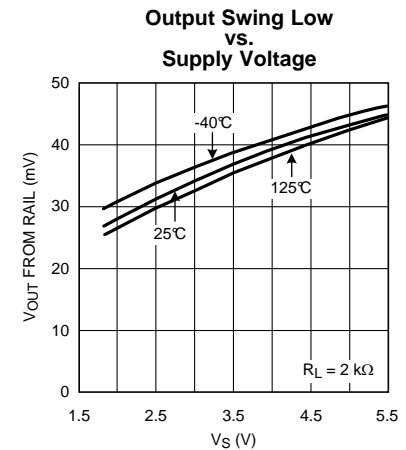

Figure 23.

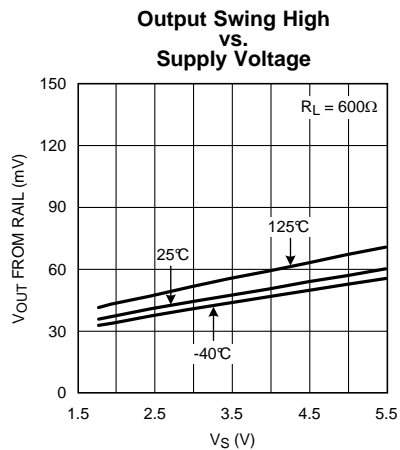

Figure 24.

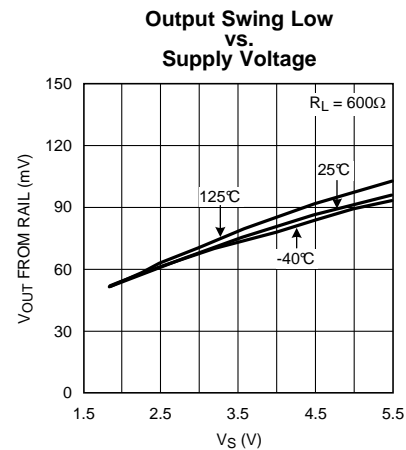

Figure 25.

Typical Performance Characteristics (continued)

Unless otherwise noted:  $T_A = 25^\circ\text{C}$ ,  $V_S = 5\text{V}$ ,  $V_{CM} = V_S/2$ .

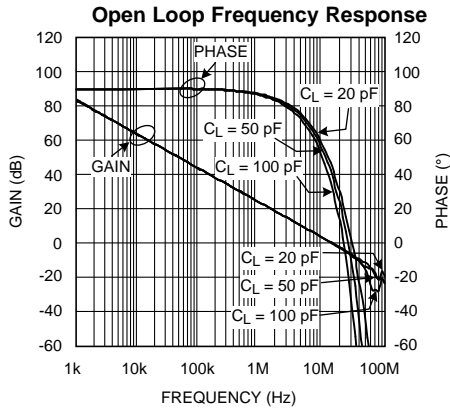

Figure 26.

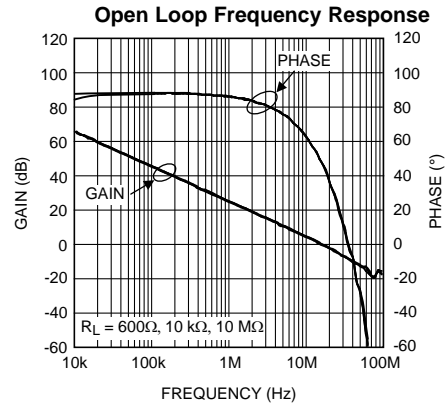

Figure 27.

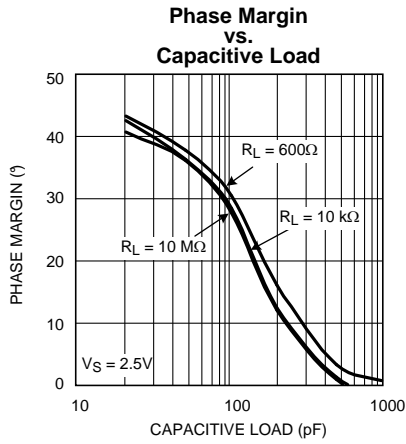

Figure 28.

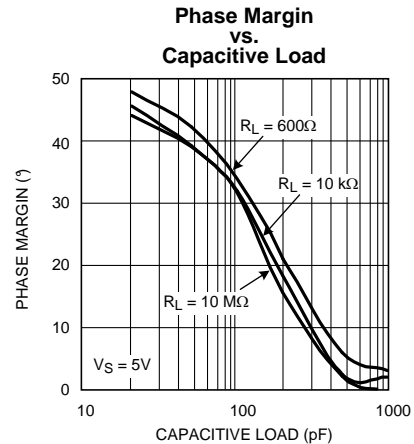

Figure 29.

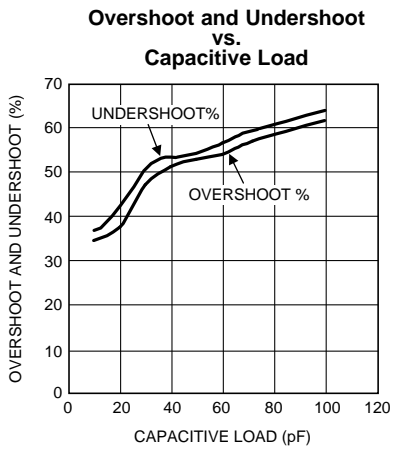

Figure 30.

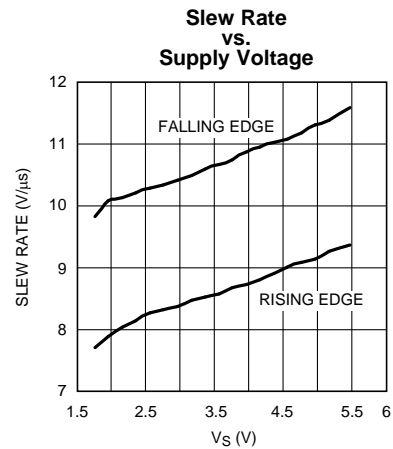
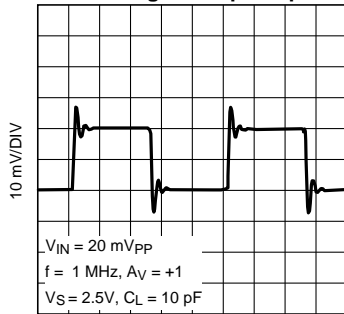

Figure 31.

**Typical Performance Characteristics (continued)**

Unless otherwise noted:  $T_A = 25^\circ\text{C}$ ,  $V_S = 5\text{V}$ ,  $V_{CM} = V_S/2$ .

**Small Signal Step Response**



200 ns/DIV

**Figure 32.**

**Large Signal Step Response**

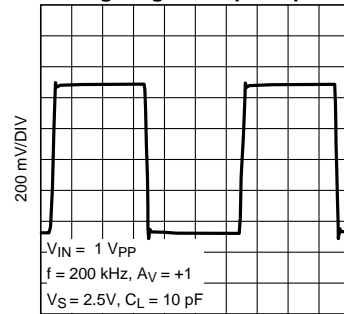

800 ns/DIV

**Figure 33.**

**Small Signal Step Response**

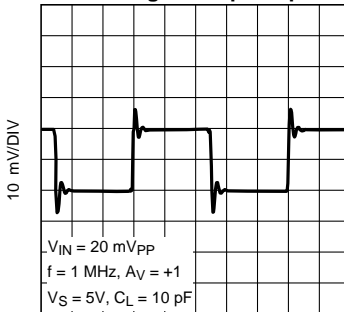

200 ns/DIV

**Figure 34.**

**Large Signal Step Response**

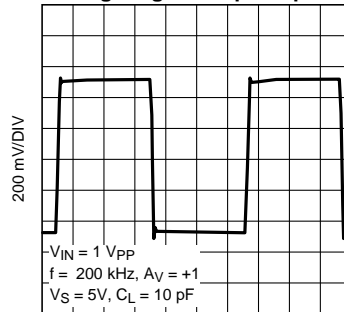

800 ns/DIV

**Figure 35.**

**THD+N vs. Output Voltage**

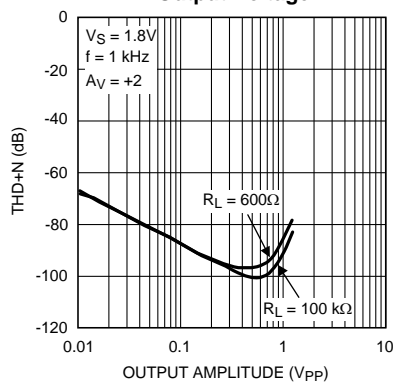

**Figure 36.**

**THD+N vs. Output Voltage**

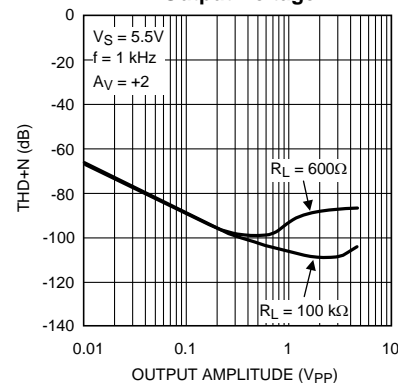

**Figure 37.**

**Typical Performance Characteristics (continued)**

Unless otherwise noted:  $T_A = 25^\circ\text{C}$ ,  $V_S = 5\text{V}$ ,  $V_{CM} = V_S/2$ .

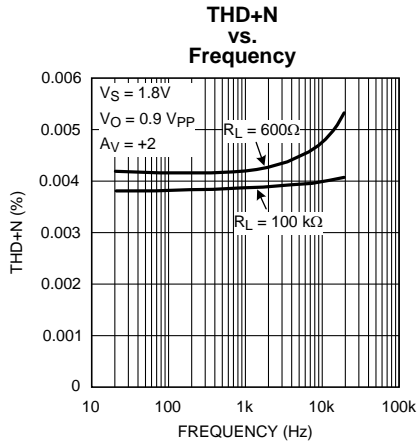

Figure 38.

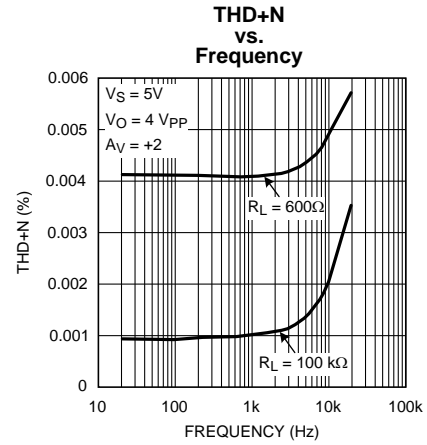

Figure 39.

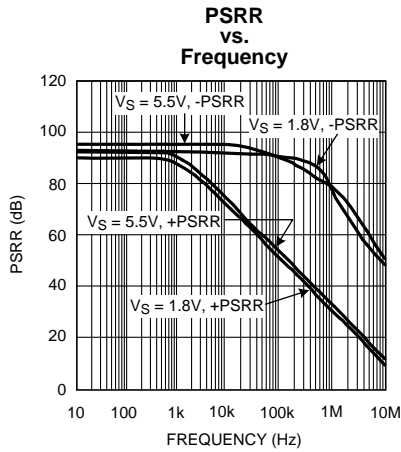

Figure 40.

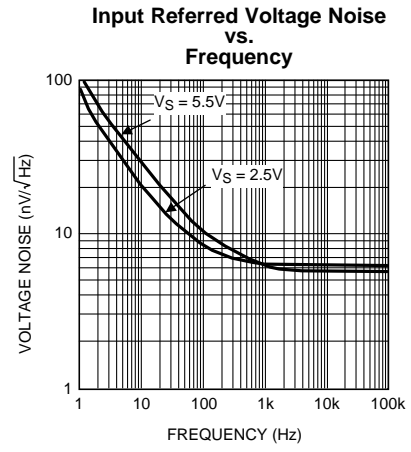

Figure 41.

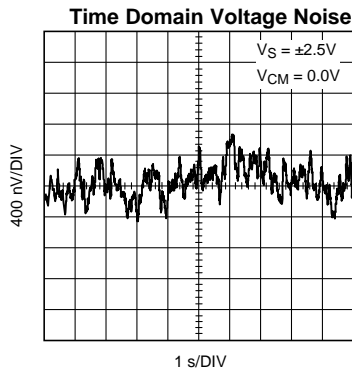

Figure 42.

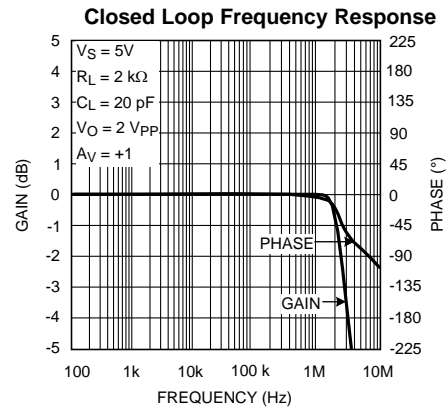
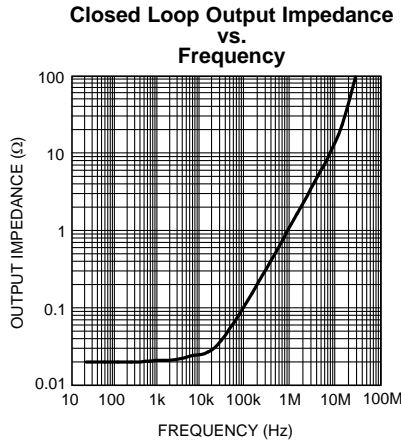

Figure 43.

**Typical Performance Characteristics (continued)**

Unless otherwise noted:  $T_A = 25^\circ\text{C}$ ,  $V_S = 5\text{V}$ ,  $V_{CM} = V_S/2$ .



**Figure 44.**

## APPLICATION INFORMATION

The SM73307 is a dual, low noise, low offset, rail-to-rail output precision amplifier with a wide gain bandwidth product of 17 MHz and low supply current. The wide bandwidth makes the SM73307 an ideal choice for wide-band amplification in photovoltaic and portable applications.

The SM73307 is superior for sensor applications. The very low input referred voltage noise of only  $5.8 \text{ nV}/\sqrt{\text{Hz}}$  at 1 kHz and very low input referred current noise of only  $10 \text{ fA}/\sqrt{\text{Hz}}$  mean more signal fidelity and higher signal-to-noise ratio.

The SM73307 has a supply voltage range of 1.8V to 5.5V over a wide temperature range of  $0^\circ\text{C}$  to  $125^\circ\text{C}$ . This is optimal for low voltage commercial applications. For applications where the ambient temperature might be less than  $0^\circ\text{C}$ , the SM73307 is fully operational at supply voltages of 2.0V to 5.5V over the temperature range of  $-40^\circ\text{C}$  to  $125^\circ\text{C}$ .

The outputs of the SM73307 swing within 25 mV of either rail providing maximum dynamic range in applications requiring low supply voltage. The input common mode range of the SM73307 extends to 300 mV below ground. This feature enables users to utilize this device in single supply applications.

The use of a very innovative feedback topology has enhanced the current drive capability of the SM73307, resulting in sourcing currents of as much as 47 mA with a supply voltage of only 1.8V.

The SM73307 is offered in an 8-pin VSSOP package. This small package is an ideal solution for applications requiring minimum PC board footprint.

### CAPACITIVE LOAD

The unity gain follower is the most sensitive configuration to capacitive loading. The combination of a capacitive load placed directly on the output of an amplifier along with the output impedance of the amplifier creates a phase lag which in turn reduces the phase margin of the amplifier. If phase margin is significantly reduced, the response will be either under-damped or the amplifier will oscillate.

The SM73307 can directly drive capacitive loads of up to 120 pF without oscillating. To drive heavier capacitive loads, an isolation resistor,  $R_{\text{ISO}}$  as shown in [Figure 45](#), should be used. This resistor and  $C_L$  form a pole and hence delay the phase lag or increase the phase margin of the overall system. The larger the value of  $R_{\text{ISO}}$ , the more stable the output voltage will be. However, larger values of  $R_{\text{ISO}}$  result in reduced output swing and reduced output current drive.

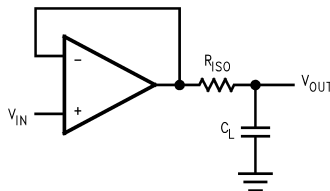

**Figure 45. Isolating Capacitive Load**

### INPUT CAPACITANCE

CMOS input stages inherently have low input bias current and higher input referred voltage noise. The SM73307 enhances this performance by having the low input bias current of only 50 fA, as well as, a very low input referred voltage noise of  $5.8 \text{ nV}/\sqrt{\text{Hz}}$ . In order to achieve this a larger input stage has been used. This larger input stage increases the input capacitance of the SM73307. [Figure 46](#) shows typical input common mode capacitance of the SM73307.

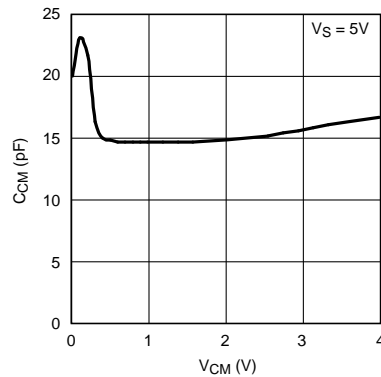

**Figure 46. Input Common Mode Capacitance**

This input capacitance will interact with other impedances, such as gain and feedback resistors which are seen on the inputs of the amplifier, to form a pole. This pole will have little or no effect on the output of the amplifier at low frequencies and under DC conditions, but will play a bigger role as the frequency increases. At higher frequencies, the presence of this pole will decrease phase margin and also cause gain peaking. In order to compensate for the input capacitance, care must be taken in choosing feedback resistors. In addition to being selective in picking values for the feedback resistor, a capacitor can be added to the feedback path to increase stability.

The DC gain of the circuit shown in [Figure 47](#) is simply  $-R_2/R_1$ .

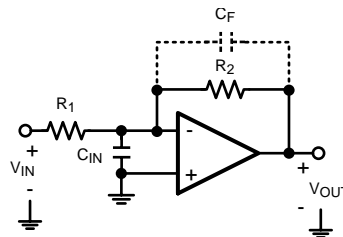

$$A_V = - \frac{V_{OUT}}{V_{IN}} = - \frac{R_2}{R_1}$$

**Figure 47. Compensating for Input Capacitance**

For the time being, ignore  $C_F$ . The AC gain of the circuit in [Figure 47](#) can be calculated as follows:

$$\frac{V_{OUT}}{V_{IN}}(s) = \frac{-R_2/R_1}{\left[ 1 + \frac{s}{\left( \frac{A_0 R_1}{R_1 + R_2} \right)} + \frac{s^2}{\left( \frac{A_0}{C_{IN} R_2} \right)} \right]} \quad (1)$$

This equation is rearranged to find the location of the two poles:

$$P_{1,2} = \frac{-1}{2C_{IN}} \left[ \frac{1}{R_1} + \frac{1}{R_2} \pm \sqrt{\left( \frac{1}{R_1} + \frac{1}{R_2} \right)^2 - \frac{4 A_0 C_{IN}}{R_2}} \right] \quad (2)$$

As shown in [Equation 2](#), as the values of  $R_1$  and  $R_2$  are increased, the magnitude of the poles are reduced, which in turn decreases the bandwidth of the amplifier. [Figure 48](#) shows the frequency response with different value resistors for  $R_1$  and  $R_2$ . Whenever possible, it is best to choose smaller feedback resistors.

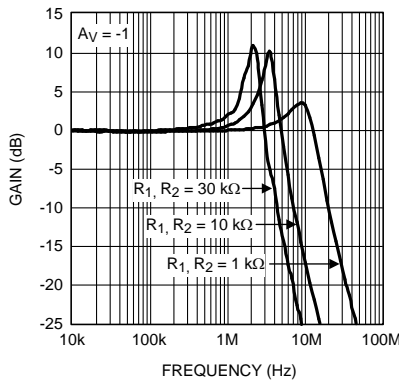

**Figure 48. Closed Loop Frequency Response**

As mentioned before, adding a capacitor to the feedback path will decrease the peaking. This is because  $C_F$  will form yet another pole in the system and will prevent pairs of poles, or complex conjugates from forming. It is the presence of pairs of poles that cause the peaking of gain. Figure 49 shows the frequency response of the schematic presented in Figure 47 with different values of  $C_F$ . As can be seen, using a small value capacitor significantly reduces or eliminates the peaking.

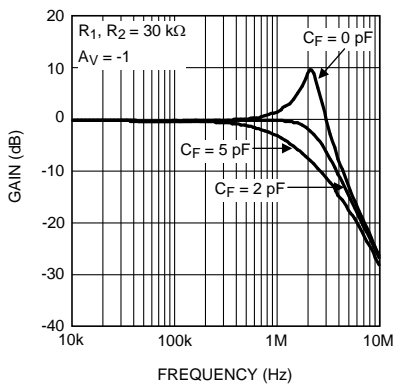

**Figure 49. Closed Loop Frequency Response**

## TRANSIMPEDANCE AMPLIFIER

In many applications the signal of interest is a very small amount of current that needs to be detected. Current that is transmitted through a photodiode is a good example. Barcode scanners, light meters, fiber optic receivers, and industrial sensors are some typical applications utilizing photodiodes for current detection. This current needs to be amplified before it can be further processed. This amplification is performed using a current-to-voltage converter configuration or transimpedance amplifier. The signal of interest is fed to the inverting input of an op amp with a feedback resistor in the current path. The voltage at the output of this amplifier will be equal to the negative of the input current times the value of the feedback resistor. Figure 50 shows a transimpedance amplifier configuration.  $C_D$  represents the photodiode parasitic capacitance and  $C_{CM}$  denotes the common-mode capacitance of the amplifier. The presence of all of these capacitances at higher frequencies might lead to less stable topologies at higher frequencies. Care must be taken when designing a transimpedance amplifier to prevent the circuit from oscillating.

With a wide gain bandwidth product, low input bias current and low input voltage and current noise, the SM73307 is ideal for wideband transimpedance applications.



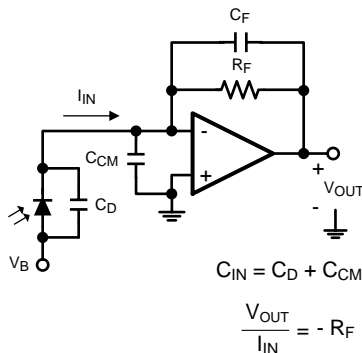
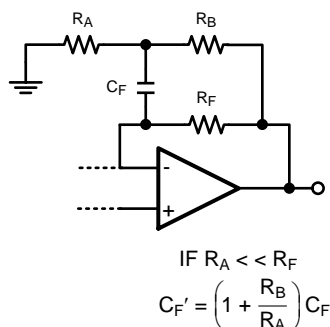

**Figure 50. Transimpedance Amplifier**

A feedback capacitance  $C_F$  is usually added in parallel with  $R_F$  to maintain circuit stability and to control the frequency response. To achieve a maximally flat, 2<sup>nd</sup> order response,  $R_F$  and  $C_F$  should be chosen by using Equation 3:

$$C_F = \sqrt{\frac{C_{IN}}{GBWP * 2 \pi R_F}} \quad (3)$$

Calculating  $C_F$  from Equation 3 can sometimes result in capacitor values which are less than 2 pF. This is especially the case for high speed applications. In these instances, it is often more practical to use the circuit shown in Figure 51 in order to allow more sensible choices for  $C_F$ . The new feedback capacitor,  $C_F'$ , is  $(1 + R_B/R_A) C_F$ . This relationship holds as long as  $R_A \ll R_F$ .

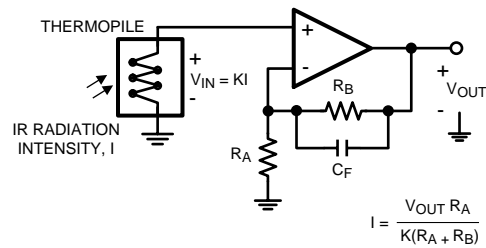

**Figure 51. Modified Transimpedance Amplifier**

## SENSOR INTERFACE

The SM73307 has a low input bias current and low input referred noise, which makes it an ideal choice for sensor interfaces such as thermopiles, Infra Red (IR) thermometry, thermocouple amplifiers, and pH electrode buffers.

Thermopiles generate voltage in response to receiving radiation. These voltages are often only a few microvolts. As a result, the operational amplifier used for this application needs to have low offset voltage, low input voltage noise, and low input bias current. Figure 52 shows a thermopile application where the sensor detects radiation from a distance and generates a voltage that is proportional to the intensity of the radiation. The two resistors,  $R_A$  and  $R_B$ , are selected to provide high gain to amplify this signal, while  $C_F$  removes the high frequency noise.

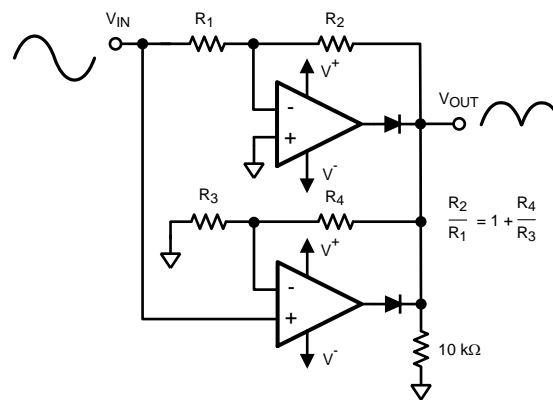

**Figure 52. Thermopile Sensor Interface**

## PRECISION RECTIFIER

Rectifiers are electrical circuits used for converting AC signals to DC signals. [Figure 53](#) shows a full-wave precision rectifier. Each operational amplifier used in this circuit has a diode on its output. This means for the diodes to conduct, the output of the amplifier needs to be positive with respect to ground. If  $V_{IN}$  is in its positive half cycle then only the output of the bottom amplifier will be positive. As a result, the diode on the output of the bottom amplifier will conduct and the signal will show at the output of the circuit. If  $V_{IN}$  is in its negative half cycle then the output of the top amplifier will be positive, resulting in the diode on the output of the top amplifier conducting and delivering the signal from the amplifier's output to the circuit's output.

For  $R_2/R_1 \geq 2$ , the resistor values can be found by using the equation shown in [Figure 53](#). If  $R_2/R_1 = 1$ , then  $R_3$  should be left open, no resistor needed, and  $R_4$  should simply be shorted.



**Figure 53. Precision Rectifier**

---

**REVISION HISTORY**

<b>Changes from Revision A (April 2013) to Revision B</b>	<b>Page</b>
<hr/> <ul style="list-style-type: none"><li>• Changed layout of National Data Sheet to TI format .....</li></ul>	<hr/> <b>18</b>

**PACKAGING INFORMATION**

Orderable Device	Status (1)	Package Type	Package Drawing	Pins	Package Qty	Eco Plan (2)	Lead finish/ Ball material (6)	MSL Peak Temp (3)	Op Temp (°C)	Device Marking (4/5)	Samples
SM73307MM/NOPB	ACTIVE	VSSOP	DGK	8	1000	RoHS & Green	SN	Level-1-260C-UNLIM	-40 to 125	S307	<a href="#">Samples</a>
SM73307MME/NOPB	ACTIVE	VSSOP	DGK	8	250	RoHS & Green	SN	Level-1-260C-UNLIM	-40 to 125	S307	<a href="#">Samples</a>
SM73307MMX/NOPB	ACTIVE	VSSOP	DGK	8	3500	RoHS & Green	SN	Level-1-260C-UNLIM	-40 to 125	S307	<a href="#">Samples</a>

(1) The marketing status values are defined as follows:

**ACTIVE:** Product device recommended for new designs.

**LIFEBUY:** TI has announced that the device will be discontinued, and a lifetime-buy period is in effect.

**NRND:** Not recommended for new designs. Device is in production to support existing customers, but TI does not recommend using this part in a new design.

**PREVIEW:** Device has been announced but is not in production. Samples may or may not be available.

**OBSELETE:** TI has discontinued the production of the device.

(2) **RoHS:** TI defines "RoHS" to mean semiconductor products that are compliant with the current EU RoHS requirements for all 10 RoHS substances, including the requirement that RoHS substance do not exceed 0.1% by weight in homogeneous materials. Where designed to be soldered at high temperatures, "RoHS" products are suitable for use in specified lead-free processes. TI may reference these types of products as "Pb-Free".

**RoHS Exempt:** TI defines "RoHS Exempt" to mean products that contain lead but are compliant with EU RoHS pursuant to a specific EU RoHS exemption.

**Green:** TI defines "Green" to mean the content of Chlorine (Cl) and Bromine (Br) based flame retardants meet JS709B low halogen requirements of <=1000ppm threshold. Antimony trioxide based flame retardants must also meet the <=1000ppm threshold requirement.

(3) MSL, Peak Temp. - The Moisture Sensitivity Level rating according to the JEDEC industry standard classifications, and peak solder temperature.

(4) There may be additional marking, which relates to the logo, the lot trace code information, or the environmental category on the device.

(5) Multiple Device Markings will be inside parentheses. Only one Device Marking contained in parentheses and separated by a "~" will appear on a device. If a line is indented then it is a continuation of the previous line and the two combined represent the entire Device Marking for that device.

(6) Lead finish/Ball material - Orderable Devices may have multiple material finish options. Finish options are separated by a vertical ruled line. Lead finish/Ball material values may wrap to two lines if the finish value exceeds the maximum column width.

**Important Information and Disclaimer:**The information provided on this page represents TI's knowledge and belief as of the date that it is provided. TI bases its knowledge and belief on information provided by third parties, and makes no representation or warranty as to the accuracy of such information. Efforts are underway to better integrate information from third parties. TI has taken and continues to take reasonable steps to provide representative and accurate information but may not have conducted destructive testing or chemical analysis on incoming materials and chemicals. TI and TI suppliers consider certain information to be proprietary, and thus CAS numbers and other limited information may not be available for release.

In no event shall TI's liability arising out of such information exceed the total purchase price of the TI part(s) at issue in this document sold by TI to Customer on an annual basis.

**TAPE AND REEL INFORMATION**

**QUADRANT ASSIGNMENTS FOR PIN 1 ORIENTATION IN TAPE**

\*All dimensions are nominal

Device	Package Type	Package Drawing	Pins	SPQ	Reel Diameter (mm)	Reel Width W1 (mm)	A0 (mm)	B0 (mm)	K0 (mm)	P1 (mm)	W (mm)	Pin1 Quadrant
SM73307MM/NOPB	VSSOP	DGK	8	1000	178.0	12.4	5.3	3.4	1.4	8.0	12.0	Q1
SM73307MME/NOPB	VSSOP	DGK	8	250	178.0	12.4	5.3	3.4	1.4	8.0	12.0	Q1
SM73307MMX/NOPB	VSSOP	DGK	8	3500	330.0	12.4	5.3	3.4	1.4	8.0	12.0	Q1

**TAPE AND REEL BOX DIMENSIONS**

\*All dimensions are nominal

Device	Package Type	Package Drawing	Pins	SPQ	Length (mm)	Width (mm)	Height (mm)
SM73307MM/NOPB	VSSOP	DGK	8	1000	210.0	185.0	35.0
SM73307MME/NOPB	VSSOP	DGK	8	250	210.0	185.0	35.0
SM73307MMX/NOPB	VSSOP	DGK	8	3500	367.0	367.0	35.0

DGK (S-PDSO-G8)

PLASTIC SMALL-OUTLINE PACKAGE



- NOTES:
- A. All linear dimensions are in millimeters.
  - B. This drawing is subject to change without notice.
  - C. Body length does not include mold flash, protrusions, or gate burrs. Mold flash, protrusions, or gate burrs shall not exceed 0.15 per end.
  - D. Body width does not include interlead flash. Interlead flash shall not exceed 0.50 per side.
  - E. Falls within JEDEC MO-187 variation AA, except interlead flash.





- NOTES:
- A. All linear dimensions are in millimeters.
  - B. This drawing is subject to change without notice.
  - C. Publication IPC-7351 is recommended for alternate designs.
  - D. Laser cutting apertures with trapezoidal walls and also rounding corners will offer better paste release. Customers should contact their board assembly site for stencil design recommendations. Refer to IPC-7525 for other stencil recommendations.
  - E. Customers should contact their board fabrication site for solder mask tolerances between and around signal pads.

## IMPORTANT NOTICE AND DISCLAIMER

TI PROVIDES TECHNICAL AND RELIABILITY DATA (INCLUDING DATASHEETS), DESIGN RESOURCES (INCLUDING REFERENCE DESIGNS), APPLICATION OR OTHER DESIGN ADVICE, WEB TOOLS, SAFETY INFORMATION, AND OTHER RESOURCES "AS IS" AND WITH ALL FAULTS, AND DISCLAIMS ALL WARRANTIES, EXPRESS AND IMPLIED, INCLUDING WITHOUT LIMITATION ANY IMPLIED WARRANTIES OF MERCHANTABILITY, FITNESS FOR A PARTICULAR PURPOSE OR NON-INFRINGEMENT OF THIRD PARTY INTELLECTUAL PROPERTY RIGHTS.

These resources are intended for skilled developers designing with TI products. You are solely responsible for (1) selecting the appropriate TI products for your application, (2) designing, validating and testing your application, and (3) ensuring your application meets applicable standards, and any other safety, security, or other requirements. These resources are subject to change without notice. TI grants you permission to use these resources only for development of an application that uses the TI products described in the resource. Other reproduction and display of these resources is prohibited. No license is granted to any other TI intellectual property right or to any third party intellectual property right. TI disclaims responsibility for, and you will fully indemnify TI and its representatives against, any claims, damages, costs, losses, and liabilities arising out of your use of these resources.

TI's products are provided subject to TI's Terms of Sale ([www.ti.com/legal/termsofsale.html](http://www.ti.com/legal/termsofsale.html)) or other applicable terms available either on [ti.com](http://ti.com) or provided in conjunction with such TI products. TI's provision of these resources does not expand or otherwise alter TI's applicable warranties or warranty disclaimers for TI products.

Mailing Address: Texas Instruments, Post Office Box 655303, Dallas, Texas 75265  
Copyright © 2020, Texas Instruments Incorporated