

FEATURES

- 200°C temperature span
- Accuracy better than $\pm 2\%$ of full scale
- Linearity better than $\pm 1\%$ of full scale
- Temperature coefficient of 22.5 mV/°C
- Output proportional to temperature $\times V+$
- Single-supply operation
- Reverse voltage protection
- Minimal self-heating
- High level, low impedance output

APPLICATIONS

- HVAC systems
- System temperature compensation
- Board level temperature sensing
- Electronic thermostats

MARKETS

- Industrial process control
- Instrumentation
- Automotive

GENERAL DESCRIPTION

The AD22100 is a monolithic temperature sensor with on-chip signal conditioning. It can be operated over the temperature range -50°C to $+150^{\circ}\text{C}$, making it ideal for use in numerous HVAC, instrumentation, and automotive applications.

The signal conditioning eliminates the need for any trimming, buffering, or linearization circuitry, greatly simplifying the system design and reducing the overall system cost.

The output voltage is proportional to the temperature \times the supply voltage (ratiometric). The output swings from 0.25 V at -50°C to 4.75 V at $+150^{\circ}\text{C}$ using a single $+5.0$ V supply.

Due to its ratiometric nature, the AD22100 offers a cost-effective solution when interfacing to an analog-to-digital converter. This is accomplished by using the ADC's $+5$ V power supply as a reference to both the ADC and the AD22100 eliminating the need for and cost of a precision reference (see Figure 2).

FUNCTIONAL BLOCK DIAGRAM

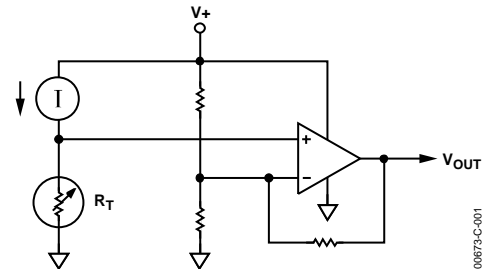

Figure 1.

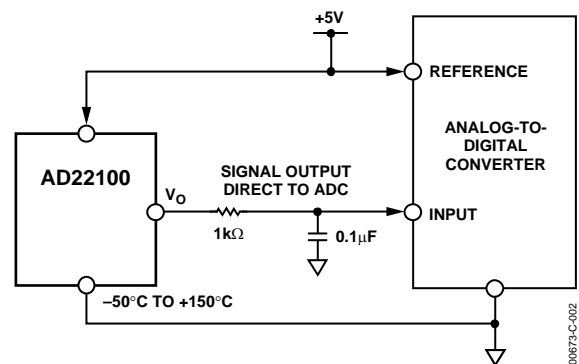

Figure 2. Application Circuit

Rev. D

Information furnished by Analog Devices is believed to be accurate and reliable. However, no responsibility is assumed by Analog Devices for its use, nor for any infringements of patents or other rights of third parties that may result from its use. Specifications subject to change without notice. No license is granted by implication or otherwise under any patent or patent rights of Analog Devices. Trademarks and registered trademarks are the property of their respective owners.

TABLE OF CONTENTS

| | | | |
|---|---|---|----|
| Specifications..... | 3 | Output Stage Considerations..... | 7 |
| Chip Specifications..... | 3 | Ratiometricity Considerations | 8 |
| Absolute Maximum Ratings..... | 4 | Mounting Considerations | 8 |
| ESD Caution..... | 4 | Thermal Environment Effects | 8 |
| Pin Configurations and Function Descriptions | 5 | Microprocessor A/D Interface Issues | 9 |
| Typical Performance Characteristics | 6 | Use with a Precision Reference as the Supply Voltage..... | 9 |
| Theory of Operation | 7 | Outline Dimensions | 10 |
| Absolute Accuracy and Nonlinearity Specifications | 7 | Ordering Guide | 11 |

REVISION HISTORY

7/04—Data Sheet Changed from Rev. C to Rev. D

| | |
|--|----|
| Change to AD22100K Specifications..... | 3 |
| Updated Outline Dimensions | 10 |
| Changes to Ordering Guide | 11 |

6/04—Data Sheet Changed from Rev. B to Rev. C

| | |
|--|-----------|
| Changes to Format | Universal |
| Changes to Specifications | 3 |
| Changes to Chip Specifications | 3 |
| Changes to Ratiometricity Considerations Section | 8 |
| Changes to Ordering Guide | 10 |
| Updated Outline Dimensions | 10 |

12/94—Data Sheet Changed from Rev. A to Rev. B

SPECIFICATIONS

$T_A = 25^\circ\text{C}$ and $V_+ = 4\text{ V}$ to 6.5 V , unless otherwise noted.

Table 1.

| Parameter | AD22100K | | | AD22100A | | | AD22100S | | | Unit |
|---|--|-------|------|----------|-------|------|----------|-------|------|-------------------|
| | Min | Typ | Max | Min | Typ | Max | Min | Typ | Max | |
| TRANSFER FUNCTION | $V_{\text{OUT}} = (V_+/5\text{ V}) \times [1.375\text{ V} + (22.5\text{ mV}/^\circ\text{C}) \times T_A]$ | | | | | | | | | V |
| TEMPERATURE COEFFICIENT | $(V_+/5\text{ V}) \times 22.5$ | | | | | | | | | mV/°C |
| TOTAL ERROR | | | | | | | | | | |
| Initial Error | | | | | | | | | | |
| $T_A = 25^\circ\text{C}$ | | ±0.5 | ±2.0 | | ±1.0 | ±2.0 | | ±1.0 | ±2.0 | °C |
| Error Overtemperature | | | | | | | | | | |
| $T_A = T_{\text{MIN}}$ | | ±0.75 | ±2.0 | | ±2.0 | ±3.7 | | ±3.0 | ±4.0 | °C |
| $T_A = T_{\text{MAX}}$ | | ±0.75 | ±2.0 | | ±2.0 | ±3.0 | | ±3.0 | ±4.0 | °C |
| Nonlinearity | | | | | | | | | | |
| $T_A = T_{\text{MAX}}$ to T_{MIN} | | | 0.5 | | | 0.5 | | | 1.0 | % FS ¹ |
| OUTPUT CHARACTERISTICS | | | | | | | | | | |
| Nominal Output Voltage | | | | | | | | | | |
| $V_+ = 5.0\text{ V}$, $T_A = 0^\circ\text{C}$ | | 1.375 | | | | | | | | V |
| $V_+ = 5.0\text{ V}$, $T_A = +100^\circ\text{C}$ | | 3.625 | | | | | | | | V |
| $V_+ = 5.0\text{ V}$, $T_A = -40^\circ\text{C}$ | | | | | 0.475 | | | | | V |
| $V_+ = 5.0\text{ V}$, $T_A = +85^\circ\text{C}$ | | | | | 3.288 | | | | | V |
| $V_+ = 5.0\text{ V}$, $T_A = -50^\circ\text{C}$ | | | | | | | | 0.250 | | V |
| $V_+ = 5.0\text{ V}$, $T_A = +150^\circ\text{C}$ | | | | | | | | 4.750 | | V |
| POWER SUPPLY | | | | | | | | | | |
| Operating Voltage | 4.0 | 5.0 | 6.5 | 4.0 | 5.0 | 6.5 | 4.0 | 5.0 | 6.5 | V |
| Quiescent Current | | 500 | 650 | | 500 | 650 | | 500 | 650 | μA |
| TEMPERATURE RANGE | | | | | | | | | | |
| Guaranteed Temperature Range | 0 | | +100 | -40 | | +85 | -50 | | +150 | °C |
| Operating Temperature Range | -50 | | +150 | -50 | | +150 | -50 | | +150 | °C |
| PACKAGE | | | | | | | | | | |
| | | TO-92 | | | TO-92 | | | TO-92 | | |
| | | SOIC | | | SOIC | | | SOIC | | |

¹ FS (full scale) is defined as the operating temperature range -50°C to $+150^\circ\text{C}$. The listed maximum specification limit applies to the guaranteed temperature range. For example, the AD22100K has a nonlinearity of $(0.5\%) \times (200^\circ\text{C}) = 1^\circ\text{C}$ over the guaranteed temperature range of 0°C to $+100^\circ\text{C}$.

CHIP SPECIFICATIONS

$T_A = 25^\circ\text{C}$ and $V_+ = 5.0\text{ V}$, unless otherwise noted.

Table 2.

| Parameter | Min | Typ | Max | Unit |
|------------------------------|--|-------|------|-------|
| TRANSFER FUNCTION | $V_{\text{OUT}} = (V_+/5\text{ V}) \times [1.375\text{ V} + (22.5\text{ mV}/^\circ\text{C}) \times T_A]$ | | | V |
| TEMPERATURE COEFFICIENT | $(V_+/5\text{ V}) \times 22.5$ | | | mV/°C |
| OUTPUT CHARACTERISTICS | | | | |
| Error | | | | |
| $T_A = 25^\circ\text{C}$ | | ±0.5 | ±2.0 | °C |
| Nominal Output Voltage | | | | |
| $T_A = 25^\circ\text{C}$ | | 1.938 | | V |
| POWER SUPPLY | | | | |
| Operating Voltage | 4.0 | 5.0 | 6.5 | V |
| Quiescent Current | | 500 | 650 | μA |
| TEMPERATURE RANGE | | | | |
| Guaranteed Temperature Range | | +25 | | °C |
| Operating Temperature Range | -50 | | +150 | °C |

ABSOLUTE MAXIMUM RATINGS

Table 3.

| Parameter | Rating |
|--|-----------------|
| Supply Voltage | 10 V |
| Reversed Continuous Supply Voltage | -10 V |
| Operating Temperature | -50°C to +150°C |
| Storage Temperature | -65°C to +160°C |
| Output Short Circuit to V+ or Ground | Indefinite |
| Lead Temperature Range (Soldering 10 sec) | 300°C |
| Junction Temperature | 150°C |

Stresses above those listed under Absolute Maximum Ratings may cause permanent damage to the device. This is a stress rating only and functional operation of the device at these or any other conditions above those indicated in the operational section of this specification is not implied. Exposure to absolute maximum rating conditions for extended periods may affect device reliability.

ESD CAUTION

ESD (electrostatic discharge) sensitive device. Electrostatic charges as high as 4000 V readily accumulate on the human body and test equipment and can discharge without detection. Although this product features proprietary ESD protection circuitry, permanent damage may occur on devices subjected to high energy electrostatic discharges. Therefore, proper ESD precautions are recommended to avoid performance degradation or loss of functionality.



PIN CONFIGURATIONS AND FUNCTION DESCRIPTIONS

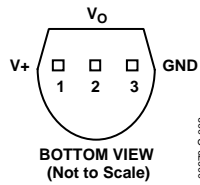

Figure 3. 3-Lead TO-92

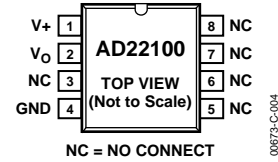

Figure 4. 8-Lead SOIC

Table 4. 3-Lead TO-92 Pin Function Descriptions

| Pin No. | Mnemonic | Description |
|---------|----------------|--------------------------------------|
| 1 | V+ | Power Supply Input. |
| 2 | V _o | Device Output. |
| 3 | GND | Ground Pin Must Be Connected to 0 V. |

Table 5. 8-Lead SOIC Pin Function Descriptions

| Pin No. | Mnemonic | Description |
|---------|----------------|--------------------------------------|
| 1 | V+ | Power Supply Input. |
| 2 | V _o | Device Output. |
| 3 | NC | No Connect. |
| 4 | GND | Ground Pin Must Be Connected to 0 V. |
| 5 | NC | No Connect. |
| 6 | NC | No Connect. |
| 7 | NC | No Connect. |
| 8 | NC | No Connect. |

TYPICAL PERFORMANCE CHARACTERISTICS

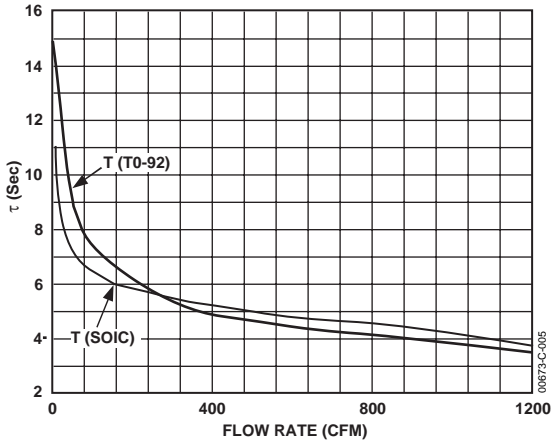

Figure 5. Thermal Response vs. Flow Rate

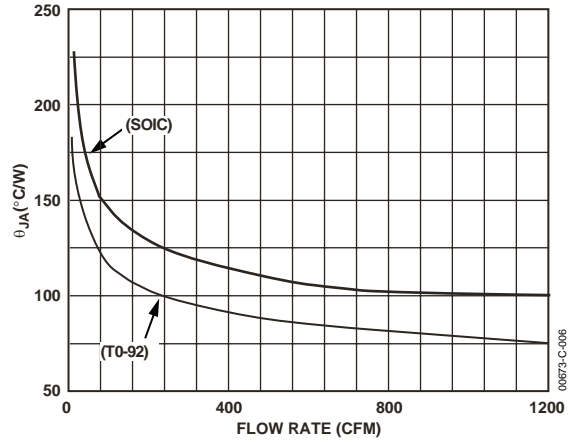

Figure 6. Thermal Resistance vs. Flow Rate

THEORY OF OPERATION

The AD22100 is a ratiometric temperature sensor IC whose output voltage is proportional to its power supply voltage. The heart of the sensor is a proprietary temperature-dependent resistor, similar to an RTD, which is built into the IC. Figure 7 shows a functional block diagram of the AD22100.

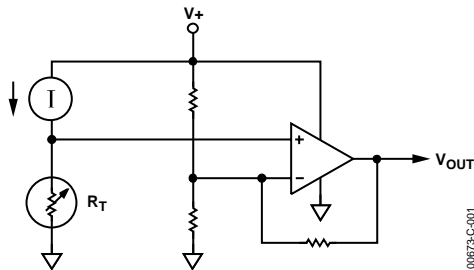

Figure 7. Simplified Block Diagram

The temperature-dependent resistor, labeled R_T , exhibits a change in resistance that is nearly linearly proportional to temperature. This resistor is excited with a current source that is proportional to the power supply voltage. The resulting voltage across R_T is therefore both supply voltage proportional and linearly varying with temperature. The remainder of the AD22100 consists of an op amp signal conditioning block that takes the voltage across R_T and applies the proper gain and offset to achieve the following output voltage function:

$$V_{OUT} = (V+/5 \text{ V}) \times (1.375 \text{ V} + 22.5 \text{ mV}/^\circ\text{C} \times T_A)$$

ABSOLUTE ACCURACY AND NONLINEARITY SPECIFICATIONS

Figure 8 graphically depicts the guaranteed limits of accuracy for the AD22100 and shows the performance of a typical part. As the output is very linear, the major sources of error are offset, for instance error at room temperature, span error, and deviation from the theoretical 22.5 mV/ $^\circ\text{C}$. Demanding applications can achieve improved performance by calibrating these offset and gain errors so that only the residual nonlinearity remains as a significant source of error.

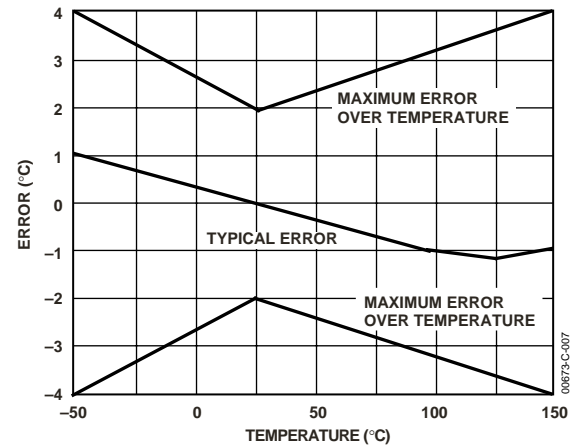

Figure 8. Typical AD22100 Performance

OUTPUT STAGE CONSIDERATIONS

As previously stated, the AD22100 is a voltage output device. A basic understanding of the nature of its output stage is useful for proper application. Note that at the nominal supply voltage of 5.0 V, the output voltage extends from 0.25 V at -50°C to +4.75 V at $+150^\circ\text{C}$. Furthermore, the AD22100 output pin is capable of withstanding an indefinite short circuit to either ground or the power supply. These characteristics are provided by the output stage structure shown in Figure 9.

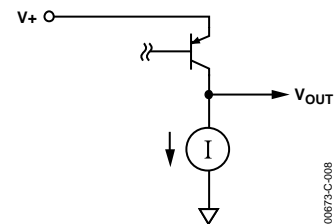

Figure 9. Output Stage Structure

The active portion of the output stage is a PNP transistor, with its emitter connected to the $V+$ supply and its collector connected to the output node. This PNP transistor sources the required amount of output current. A limited pull-down capability is provided by a fixed current sink of about $-80 \mu\text{A}$, with the term fixed referring to a current sink that is fairly insensitive to either supply voltage or output loading conditions. The current sink capability is a function of temperature, increasing its pull-down capability at lower temperatures.

AD22100

Due to its limited current sinking ability, the AD22100 is incapable of driving loads to the V+ power supply and is instead intended to drive grounded loads. A typical value for short-circuit current limit is 7 mA, so devices can reliably source 1 mA or 2 mA. However, for best output voltage accuracy and minimal internal self-heating, output current should be kept below 1 mA. Loads connected to the V+ power supply should be avoided as the current sinking capability of the AD22100 is fairly limited. These considerations are typically not a problem when driving a microcontroller analog-to-digital converter input pin (see the Microprocessor A/D Interface Issues section).

RATIOMETRICITY CONSIDERATIONS

The AD22100 will operate with slightly better accuracy than that listed in the data sheet specifications if the power supply is held constant. This is because the AD22100's output voltage varies with both temperature and supply voltage, with some errors. The ideal transfer function describing output voltage is:

$$(V+/5 V) \times (1.375 V + 22.5 \text{ mV}/^\circ\text{C} \times T_A)$$

The ratiometricity error is defined as the percent change away from the ideal transfer function as the power supply voltage changes within the operating range of 4 V to 6.5 V. For the AD22100, this error is typically less than 1%. A movement from the ideal transfer function by 1% at 25°C, with a supply voltage varying from 5.0 V to 5.50 V, results in a 1.94 mV change in output voltage or 0.08°C error. This error term is greater at higher temperatures because the output (and error term) is directly proportional to temperature. At 150°C, the error in output voltage is 4.75 mV or 0.19°C.

For example, with $V_S = 5.0 \text{ V}$, and $T_A = +25^\circ\text{C}$, the nominal output of the AD22100 will be 1.9375 V. At $V_S = 5.50 \text{ V}$, the nominal output will be 2.1313 V, an increase of 193.75 mV. A proportionality error of 1% is applied to the 193.75 mV, yielding an error term of 1.9375 mV. This error term translates to a variation in output voltage of 2.1293 V to 2.3332 V. A 1.94 mV error at the output is equivalent to about 0.08°C error in accuracy.

If 150°C is substituted for 25°C in the above example, the error term translates to a variation in output voltage of 5.2203 V to 5.2298 V. A 4.75 mV error at the output is equivalent to about 0.19°C error in accuracy.

MOUNTING CONSIDERATIONS

If the AD22100 is thermally attached and properly protected, it can be used in any measuring situation where the maximum range of temperatures encountered is between -50°C and $+150^\circ\text{C}$. Because plastic IC packaging technology is employed, excessive mechanical stress must be avoided when fastening the device with a clamp or screw-on heat tab. Thermally conductive epoxy or glue is recommended for typical mounting conditions. In wet or corrosive environments, an electrically isolated metal or ceramic well should be used to shield the AD22100. Because the part has a voltage output (as opposed to current), it offers modest immunity to leakage errors, such as those caused by condensation at low temperatures.

THERMAL ENVIRONMENT EFFECTS

The thermal environment in which the AD22100 is used determines two performance traits: the effect of self-heating on accuracy and the response time of the sensor to rapid changes in temperature. In the first case, a rise in the IC junction temperature above the ambient temperature is a function of two variables: the power consumption of the AD22100 and the thermal resistance between the chip and the ambient environment θ_{JA} . Self-heating error in °C can be derived by multiplying the power dissipation by θ_{JA} . Because errors of this type can vary widely for surroundings with different heat-sinking capacities, it is necessary to specify θ_{JA} under several conditions. Table 6 shows how the magnitude of self-heating error varies relative to the environment. A typical part will dissipate about 2.2 mW at room temperature with a 5 V supply and negligible output loading. Table 6 indicates a θ_{JA} of 190°C/W in still air, without a heat sink, yielding a temperature rise of 0.4°C. Thermal rise will be considerably less in either moving air or with direct physical connection to a solid (or liquid) body.

Table 6. Thermal Resistance (TO-92)

| Medium | θ_{JA} (°C/W) | t (sec) ¹ |
|-------------------------|----------------------|----------------------|
| Aluminum Block | 60 | 2 |
| Moving Air ² | | |
| Without Heat Sink | 75 | 3.5 |
| Still Air | | |
| Without Heat Sink | 190 | 15 |

Response of the AD22100 output to abrupt changes in ambient temperature can be modeled by a single time constant t exponential function. Figure 10 shows the typical response time plots for a few media of interest.

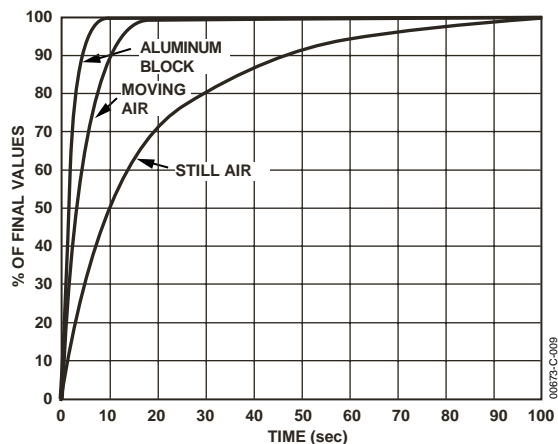

Figure 10. Response Time

The time constant t is dependent on θ_{JA} and the thermal capacities of the chip and the package. Table 6 lists the effective t (time to reach 63.2% of the final value) for a few different media. Copper printed circuit board connections were neglected in the analysis; however, they will sink or conduct heat directly through the AD22100's solder plated copper leads. When faster response is required, a thermally conductive grease or glue between the AD22100 and the surface temperature being measured should be used.

MICROPROCESSOR A/D INTERFACE ISSUES

The AD22100 is especially well suited to providing a low cost temperature measurement capability for microprocessor/microcontroller based systems. Many inexpensive 8-bit microprocessors now offer an onboard 8-bit ADC capability at a modest cost premium. Total cost of ownership then becomes a function of the voltage reference and analog signal conditioning necessary to mate the analog sensor with the microprocessor ADC. The AD22100 can provide an ideal low cost system by eliminating the need for a precision voltage reference and any additional active components. The ratiometric nature of the AD22100 allows the microprocessor to use the same power supply as its ADC reference. Variations of hundreds of millivolts in the supply voltage have little effect as both the AD22100 and the ADC use the supply as their reference. The nominal AD22100 signal range of 0.25 V to 4.75 V (-50°C to $+150^{\circ}\text{C}$) makes good use of the input range of a 0 V to 5 V ADC. A single resistor and capacitor are recommended to provide immunity to the high speed charge dump glitches seen at many microprocessor ADC inputs (see Figure 2).

An 8-bit ADC with a reference of 5 V will have a least significant bit (LSB) size of $5\text{ V}/256 = 19.5\text{ mV}$. This corresponds to a nominal resolution of about 0.87°C .

USE WITH A PRECISION REFERENCE AS THE SUPPLY VOLTAGE

While the ratiometric nature of the AD22100 allows for system operation without a precision voltage reference, it can still be used in such systems. Overall system requirements involving other sensors or signal inputs may dictate the need for a fixed precision ADC reference. The AD22100 can be converted to absolute voltage operation by using a precision reference as the supply voltage. For example, a 5.00 V reference can be used to power the AD22100 directly. Supply current will typically be 500 μA , which is usually within the output capability of the reference. Using a large number of AD22100s may require an additional op amp buffer, as would scaling down a 10.00 V reference that might be found in instrumentation ADCs typically operating from $\pm 15\text{ V}$ supplies.

¹ The time constant t is defined as the time to reach 63.2% of the final temperature change.

² 1200 CFM.

OUTLINE DIMENSIONS

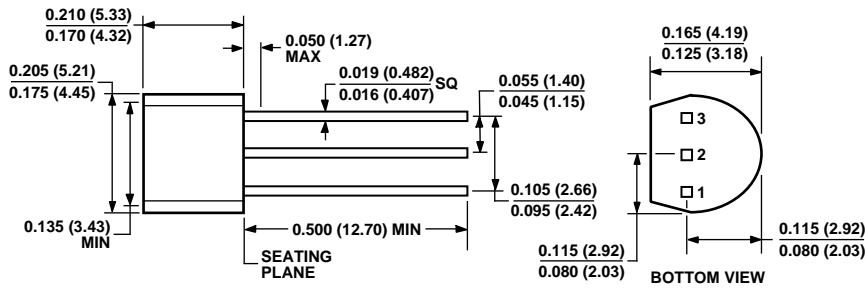

COMPLIANT TO JEDEC STANDARDS TO-226AA
 CONTROLLING DIMENSIONS ARE IN INCHES; MILLIMETER DIMENSIONS
 (IN PARENTHESES) ARE ROUNDED-OFF EQUIVALENTS FOR
 REFERENCE ONLY AND ARE NOT APPROPRIATE FOR USE IN DESIGN

Figure 11. 3-Pin Plastic Header Package [TO-92]
 (T-3)

Dimensions shown in inches and millimeters

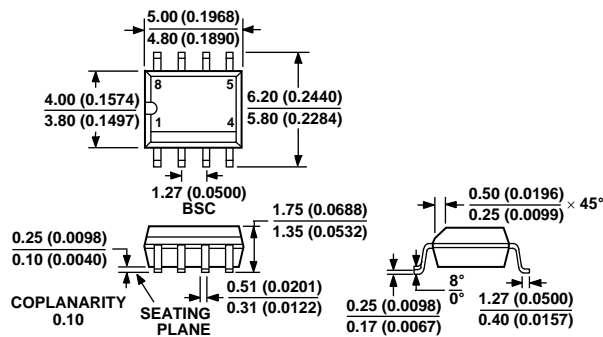

COMPLIANT TO JEDEC STANDARDS MS-012AA
 CONTROLLING DIMENSIONS ARE IN MILLIMETERS; INCH DIMENSIONS
 (IN PARENTHESES) ARE ROUNDED-OFF MILLIMETER EQUIVALENTS FOR
 REFERENCE ONLY AND ARE NOT APPROPRIATE FOR USE IN DESIGN

Figure 12. 8-Lead Standard Small Outline Package [SOIC]
 (R-8)

Dimensions shown in inches and millimeters

ORDERING GUIDE

| Models | Temperature Range | Package Description | Package Outline |
|-------------------------------|--------------------------|--|------------------------|
| AD22100KT | 0°C to +100°C | 3-Pin Plastic Header Package (TO-92) | T-3 |
| AD22100KR | 0°C to +100°C | 8-Lead Standard Small Outline Package (SOIC) | R-8 |
| AD22100KR-REEL7 | 0°C to +100°C | 8-Lead Standard Small Outline Package (SOIC) | R-8 |
| AD22100KRZ ¹ | 0°C to +100°C | 8-Lead Standard Small Outline Package (SOIC) | R-8 |
| AD22100KRZ-REEL7 ¹ | 0°C to +100°C | 8-Lead Standard Small Outline Package (SOIC) | R-8 |
| AD22100AT | -40°C to +85°C | 3-Pin Plastic Header Package (TO-92) | T-3 |
| AD22100AR | -40°C to +85°C | 8-Lead Standard Small Outline Package (SOIC) | R-8 |
| AD22100AR-REEL | -40°C to +85°C | 8-Lead Standard Small Outline Package (SOIC) | R-8 |
| AD22100AR-REEL7 | -40°C to +85°C | 8-Lead Standard Small Outline Package (SOIC) | R-8 |
| AD22100ST | -50°C to +150°C | 3-Pin Plastic Header Package (TO-92) | T-3 |
| AD22100SR | -50°C to +150°C | 8-Lead Standard Small Outline Package (SOIC) | R-8 |
| AD22100SR-REEL7 | -50°C to +150°C | 8-Lead Standard Small Outline Package (SOIC) | R-8 |
| AD22100SRZ ¹ | -50°C to +150°C | 8-Lead Standard Small Outline Package (SOIC) | R-8 |
| AD22100SRZ-REEL7 ¹ | -50°C to +150°C | 8-Lead Standard Small Outline Package (SOIC) | R-8 |
| AD22100KCHIPS | | DIE | |

¹ Z = Pb-free part.

AD22100

NOTES

Mouser Electronics

Authorized Distributor

Click to View Pricing, Inventory, Delivery & Lifecycle Information:

[Analog Devices Inc.:](#)

[AD22100ARZ](#) [AD22100AR](#) [AD22100STZ](#) [AD22100SR-REEL7](#) [AD22100ARZ-RL](#) [AD22100AR-REEL](#)
[AD22100KRZ-REEL7](#) [AD22100AR-REEL7](#) [AD22100SR](#) [AD22100AT](#) [AD22100SRZ-REEL7](#) [AD22100SRZ](#)
[AD22100KTZ](#) [AD22100ARZ-R7](#) [AD22100KT](#) [AD22100ATZ](#) [AD22100KRZ](#)