

ECM40-60



- 40 & 60 Watt Models
- Small Size 2.0"x 4.0"x 1.2"
- Low Leakage Current
- Industrial & Medical Approvals
- Full Load Available Convection Cooled
- Wide Operating Temperature 0 °C to +70 °C
- Level B Conducted Emissions
- EN61000 Compliant
- Universal AC Input 90-264 VAC
- Input Frequency 47-63 & 440 Hz
- Single & Multiple Outputs
- Cover Kits Available
- Mating Connector & Loom Kits Available

Approved for Class I and Class II applications, the ECM range of single and multiple output AC-DC, 40-60 W power supplies from XP feature the world's smallest footprint for units of these ratings. Both are just 2" x 4" (50.8 mm x 101.6 mm) and 1.2" (30.48 mm) high. Furthermore, these high-density power supplies meet EN55032 Level B conducted emissions with maximum leakage currents of 100 μ A at 115 VAC or 200 μ A at 230 VAC. As a result, these switchers are equally suitable for industrial, IT and medical applications, with no price premium for meeting medical requirements.

The ECM40-60 series have single output versions from 5 V to 48 VDC, adjustable by $\pm 10\%$, and dual and triple output versions covering combinations of 3.3 V, 5 V, 12 V, 15 V and 24 V. They are dual-fused for compliance with IEC60601-1 and efficiency is 80-85%, depending upon the model, so minimal excess heat is generated.

The power supplies deliver full power between 0 °C and +50 °C and will operate at up to +70 °C with derating and only 5 CFM of cooling. Comprehensive overvoltage, overload and short circuit protection is built in. Covers, looms and connector kits are available.

Input Characteristics

Characteristic	Minimum	Typical	Maximum	Units	Notes & Conditions
Input Voltage - Operating	90		264	VAC	120-370 VDC
Input Frequency	47	50/60	63	Hz	400 Hz operation available
Input Current - No load			41	mA	230 VAC
Input Current - Full load			1.38	A	90 VAC
Inrush Current			40	A	Cold start at 230 VAC
Power Factor		0.62			230 VAC
Earth Leakage Current			290	μA	264 VAC
Input Protection					T3.15 A/ 250 V internal fuse in line & neutral

All specifications are at nominal input, full resistance load at 25°C unless otherwise stated.

Output Characteristics

Characteristic	Minimum	Typical	Maximum	Units	Notes & Conditions
Output Voltage	5.0		48.0	VDC	See modules table
Initial Set Accuracy			V ¹ : ±1, V ² & V ³ : ±5	%	
Output Voltage Trim	±10			%	V ¹ (V ² will track V ¹ by the same %)
Minimum load	V ¹ : 0.5, V ² : 0.1			A	Not required on single output models
Start Up Delay			1.5	s	90 VAC
Start Up Rise Time			10	ms	
Hold Up Time	16		75	ms	115-230 VAC input
Drift			±0.2	%	
Line Regulation			±0.5	%	90-264 VAC
Load Regulation			±1.0	%	Single output
			V ¹ : ±3, V ² & V ³ : ±5	%	Dual output
Transient Response			4	%	Output voltage recovers to within 1% in less than 500 μs for 50% load change.
Ripple & Noise			1	%pk-pk	20 MHz bandwidth
Overvoltage Protection	115		135	VDC	Recycle input to reset
Overload Protection	110		170	% I _{max}	Auto-recovery
Short Circuit Protection					Trip & restart (hiccup mode)
Temperature Coefficient			0.05	%/°C	

General Specifications

Characteristic	Minimum	Typical	Maximum	Units	Notes & Conditions	
Efficiency	70			%	3.3 & 5 V single output versions	
	80				(at 230 VAC full load)	All other single output versions
	75					Dual output versions
Isolation Voltage		4000		VAC	Input to output	
		1500			Input to ground	
		500			Output to ground	
Switching Frequency		70		kHz	Fixed	
Power Density			6.25	W/In ³	For 60 W version	
Weight		0.33 (150)		lbs (g)		
MTBF		600		kHrs	Mil HDBK 217F	

Environmental

Characteristic	Minimum	Typical	Maximum	Units	Notes & Conditions
Operating Temperature	-0		+70	°C	See derating curves
Storage Temperature	-40		+85	°C	
Cooling		0		CFM	Convection-cooled
Operating Humidity			95	% RH	Non- condensing
Operating Altitude			3000	m	
Shock			30	Gpk	Half sine 6 axis
Vibration			2	G	5-500 Hz 3 axis

Electromagnetic Compatibility & Immunity

Standard	Test Level	Criteria	Notes & Conditions
Emissions	EN55032	Class B Conducted	
	EN55032	Class A Radiated	
	EN60601-1-2	Class B Conducted	
Harmonic Currents	EN61000-3-2		
Voltage Flicker	EN61000-3-3		
ESD Immunity	EN61000-4-2	level 2, performance criteria A	
Radiated Immunity	EN61000-4-3	10 V/m, performance criteria A	
EFT/Burst	EN61000-4-4	level 2, performance criteria A	
Surge	EN61000-4-5	level 3, performance criteria A	
Conducted Immunity	EN61000-4-6	10 Vrms, performance criteria A	
Dips & Interruptions	EN61000-4-11	70% U ^T : performance criteria A	For 10 ms, 100% load
		40% U ^T : performance criteria B	For 100 ms, 100% load
		0% U ^T : performance criteria B	For 5000 ms, 100% load
Dips & Interruptions	EN61000-4-11 (Medical)	70% U _t , performance criteria A	For 500 ms, Medical, 100% load
		40% U _t , performance criteria A	For 100 ms, Medical, 60% load
		0% U _t , performance criteria A	For 10 ms, Medical, 100% load
		0% U _t , performance criteria B	For 5000 ms, Medical, 100% load

Safety Approvals

Safety Agency	Safety Standard	Category
CB Report	IEC60950-1:2005 Ed 2 / IEC62368-1:2014	Information Technology
	Certificate #US/18293 & 18269/UL, IEC60601-1 Ed 3 Including Risk Management	Medical
UL	UL 62368-1 & CAN/CSA C22.2 No. 62368-1-14	Information Technology
	UL File # E146893, ANSI/AAMI ES 60601-1:2005 & CSA C22.2 No. 60601-1:08	Medical
EN	EN62368-1:2014/A11:2017	Information Technology
	TUV Certificate # B12 01 57396 125, EN60601-1:2006	Medical
CE	Meets all applicable directives	
UKCA	Meets all applicable legislation	

Means of Protection		Category
Primary to Secondary	1 x MOPP (Means of Patient Protection) Contact Sales for 2 x MOPP	IEC60601-1 Ed 3
Primary to Earth	1 x MOPP (Means of Patient Protection)	

Equipment Protection Class	Safety Standard	Notes & Conditions
Class I & Class II	IEC60950-1:2005 Ed 2 / IEC62368-1:2014	See safety agency conditions of acceptability for details

Models & Ratings

Max Power	Outputs						Model Number
	V1	Imin/Imax ^③	V2	Imin/Imax	V3	Imin/Imax	
40 W	5.0V	0.0 A / 8.0 A					ECM40US05
	7.0V	0.0 A / 5.7 A					ECM40US07
	9.0V	0.0 A / 4.4 A					ECM40US09
	12.0V	0.0 A / 3.5 A					ECM40US12
	15.0V	0.0 A / 2.7 A					ECM40US15
	18.0V	0.0 A / 2.2 A					ECM40US18
	24.0V	0.0 A / 1.7 A					ECM40US24
	33.0V	0.0 A / 1.2 A					ECM40US33
	48.0V	0.0 A / 0.9 A					ECM40US48
	+5.0V	0.5 A / 6.0 A	+12.0V	0.1 A / 2.0 A			ECM40UD21
	+5.0V	0.5 A / 6.0 A	+15.0V	0.1 A / 1.5 A			ECM40UD22
	+5.0V	0.5 A / 6.0 A	+12.0V	0.1 A / 2.0 A	-12.0V	0.0 A / 0.5 A	ECM40UT31
	+5.0V	0.5 A / 6.0 A	+24.0V	0.1 A / 1.0 A	-12.0V	0.0 A / 0.5 A	ECM40UT32
	+5.0V	0.5 A / 6.0 A	+15.0V	0.1 A / 1.5 A	-15.0V	0.0 A / 0.5 A	ECM40UT33
	+3.3V	0.5 A / 6.0 A	+5.0V	0.1 A / 1.5 A	+12.0V	0.0 A / 0.5 A	ECM40UT34
	+5.0V	0.5 A / 6.0 A	+3.3V	0.1 A / 1.5 A	+12.0V	0.0 A / 0.5 A	ECM40UT35

Max Power	Outputs						Model Number
	V1	Imin/Imax ^③	V2	Imin/Imax	V3	Imin/Imax	
60 W	5.0V	0.0 A / 12.00 A					ECM60US05
	7.0V	0.0 A / 8.60 A					ECM60US07
	9.0V	0.0 A / 6.70 A					ECM60US09
	12.0V	0.0 A / 5.00 A					ECM60US12
	15.0V	0.0 A / 4.00 A					ECM60US15
	18.0V	0.0 A / 3.30 A					ECM60US18
	20.0V	0.0 A / 3.00 A					ECM60US20
	24.0V	0.0 A / 2.50 A					ECM60US24
	28.0V	0.0 A / 2.14 A					ECM60US28
	33.0V	0.0 A / 1.80 A					ECM60US33
	48.0V	0.0 A / 1.25 A					ECM60US48
	+5.0V	0.5 A / 8.00 A	+12.0V	0.1 A / 3.0 A			ECM60UD21
	+5.0V	0.5 A / 8.00 A	+15.0V	0.1 A / 2.5 A			ECM60UD22
	+5.0V	0.5 A / 8.00 A	+12.0V	0.1 A / 3.0 A	-12.0V	0.0 A / 0.5 A	ECM60UT31
	+5.0V	0.5 A / 8.00 A	+24.0V	0.1 A / 1.5 A	-12.0V	0.0 A / 0.5 A	ECM60UT32
	+5.0V	0.5 A / 8.00 A	+15.0V	0.1 A / 2.5 A	-15.0V	0.0 A / 0.5 A	ECM60UT33
	+3.3V	0.5 A / 8.00 A	+5.0V	0.1 A / 1.5 A	+12.0V	0.0 A / 0.5 A	ECM60UT34
	+5.0V	0.5 A / 8.00 A	+3.3V	0.1 A / 1.5 A	+12.0V	0.0 A / 0.5 A	ECM60UT35

Notes

1. V2 will track a change in V1 by the same percentage change in voltage as V1 is trimmed.
2. To receive unit with cover fitted, add suffix '-C' to model number. For Class I operation only.
3. A 120% peak load can be taken for up to 100 ms with a 25% duty cycle. Average load not to exceed maximum power rating.

Thermal Derating Curves

All ECM40 models convection-cooled

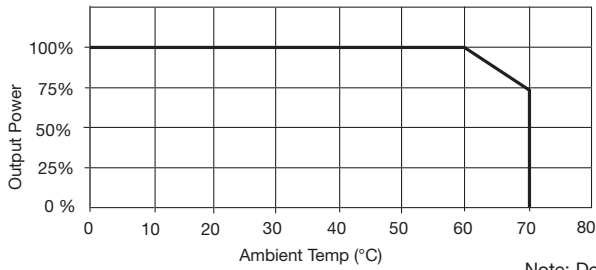

Note: Derate by 10% if cover is fitted

All ECM40 models with 5 CFM

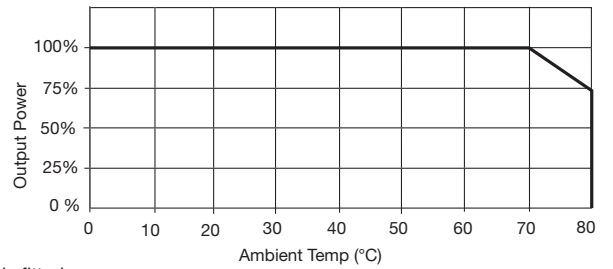

All ECM60 models convection-cooled

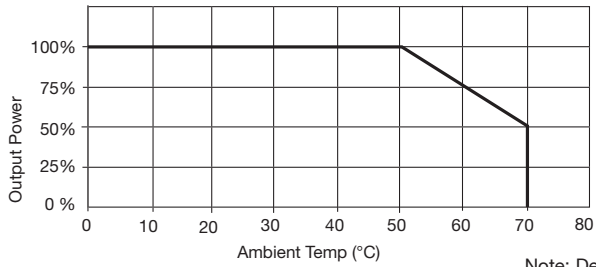

Note: Derate by 10% if cover is fitted

All ECM60 models with 5 CFM

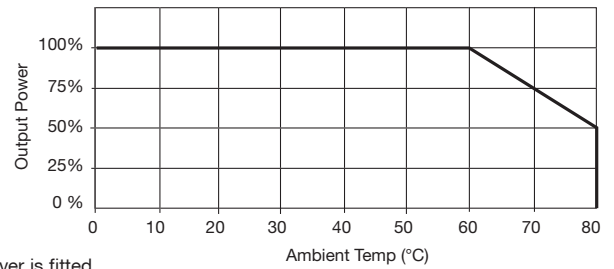

Transient Response

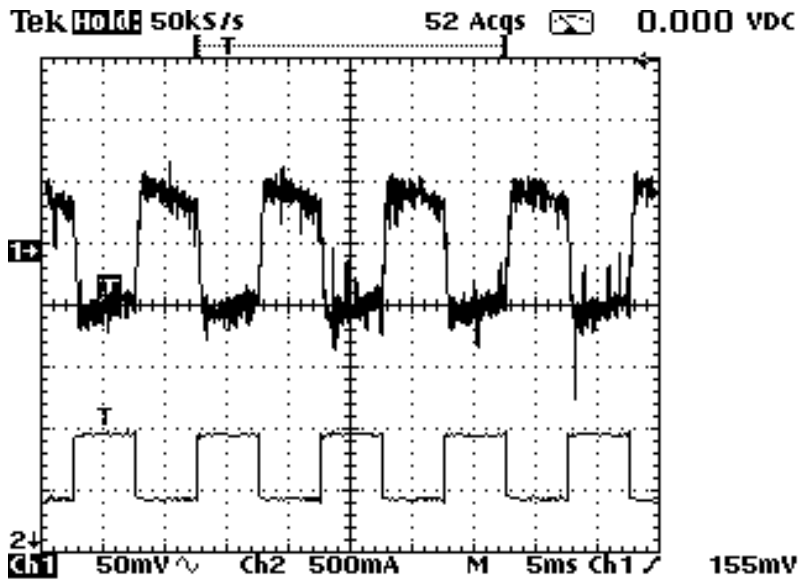

ECM60US24 25% load change

Efficiency Versus Input Voltage

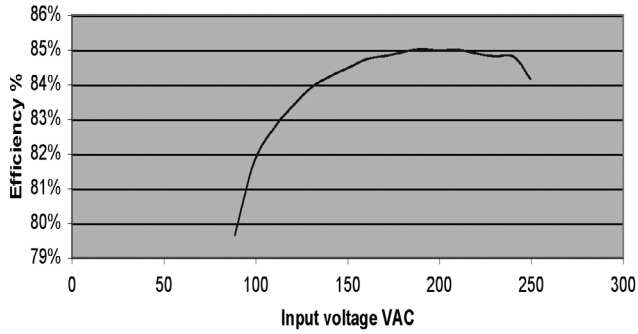

ECM60US24 with 60 W load

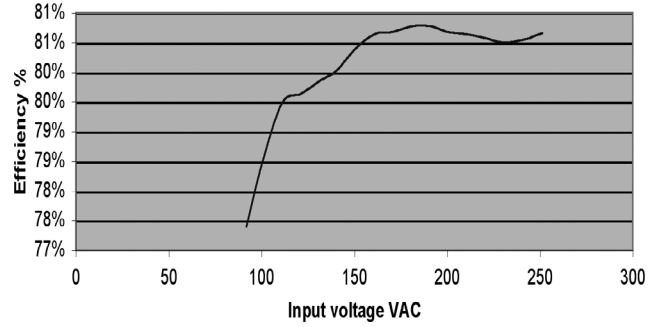

ECM60UT33 with 50 W load

Efficiency Versus Output Load

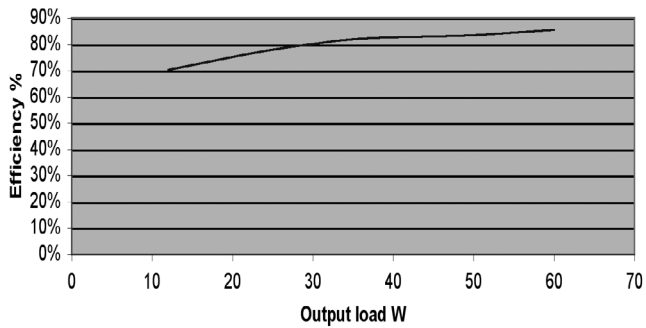

ECM60US24 at 230 VAC input

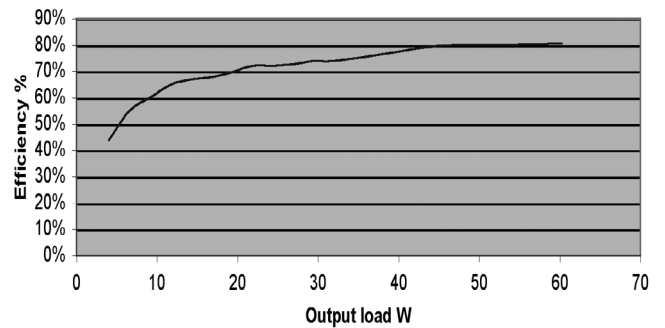

ECM60UT33 at 230 VAC input

Start Up Delay

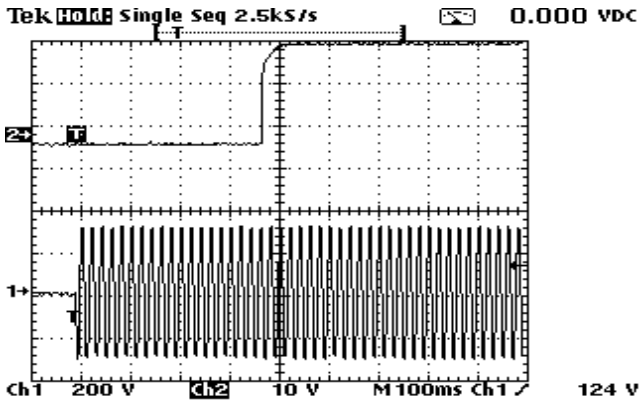

ECM60US24 with 60 W load

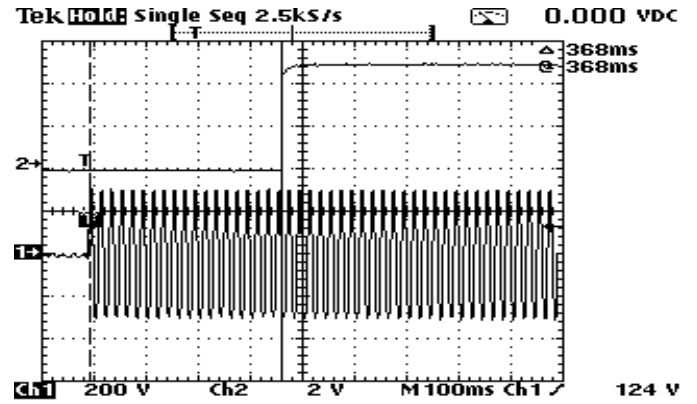

ECM60UT33 with 60 W load

Hold Up Time

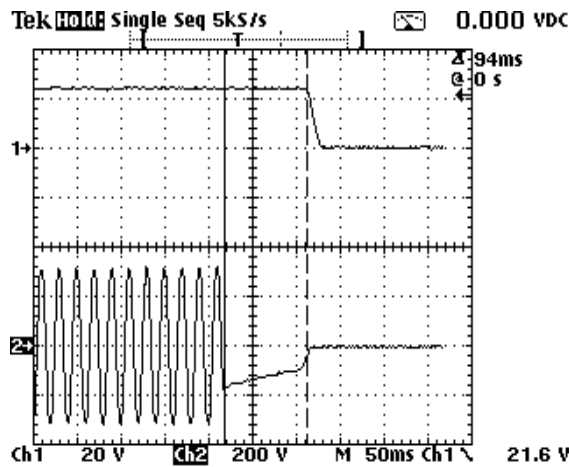

ECM60US24 with 60 W load at 230 VAC

Overload Characteristics

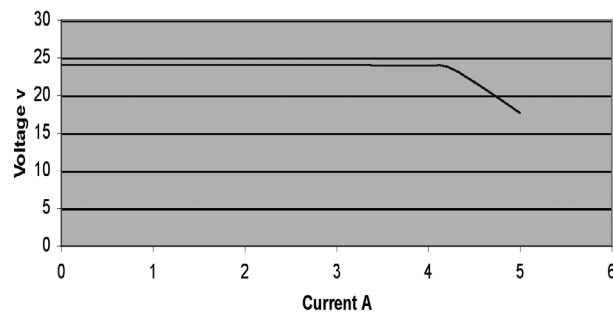

ECM60US24. When current reaches 5.4 A, output goes into trip and restart (hiccup) mode

Ripple & Noise

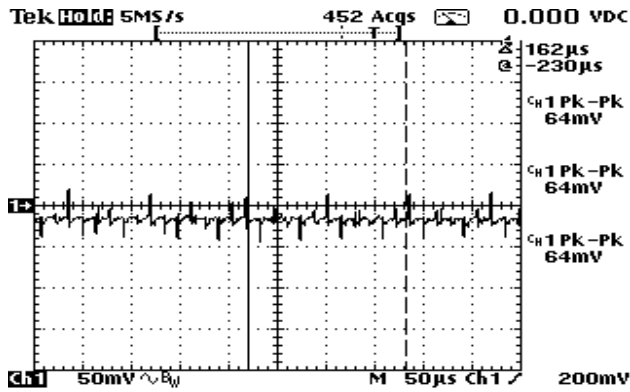

ECM60US24 with 60 W load
 Noise measured is 64 mV pk-pk

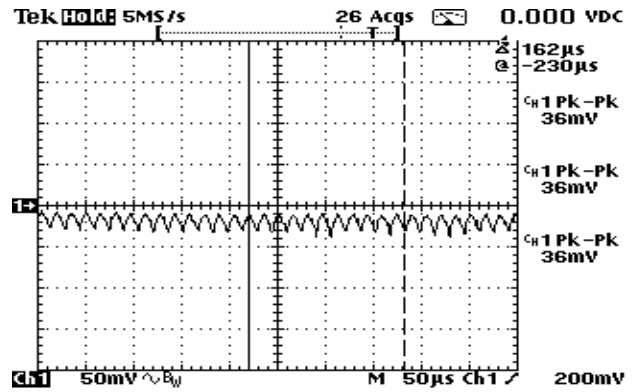

ECM60UT33 output 1 with 30 W load.
 Noise measured is 36 mV pk-pk

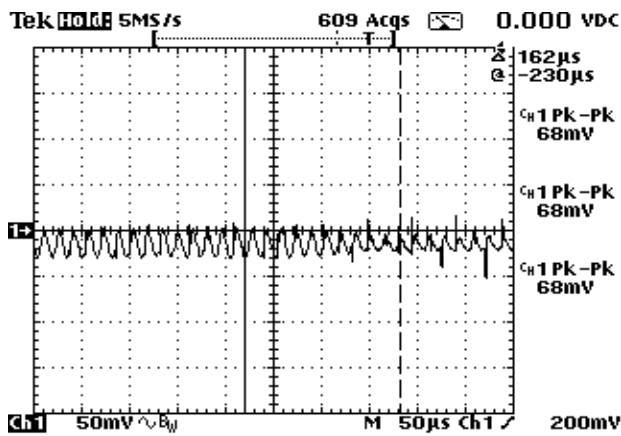

ECM60UT33 output 2 with 15 W load.
 Noise measured is 68 mV pk-pk

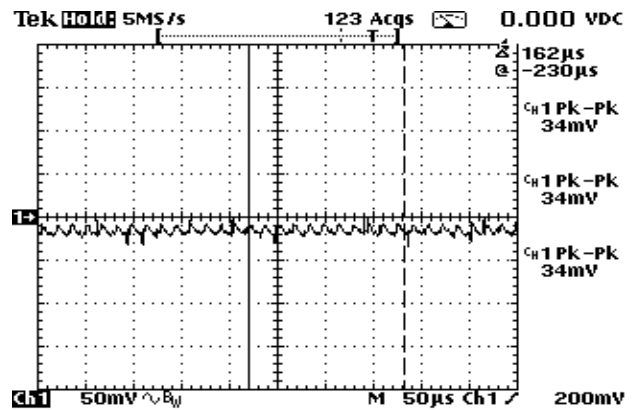

ECM60UT33 output 3 with 7 W load.
 Noise measured is 34 mV pk-pk

Conducted Noise

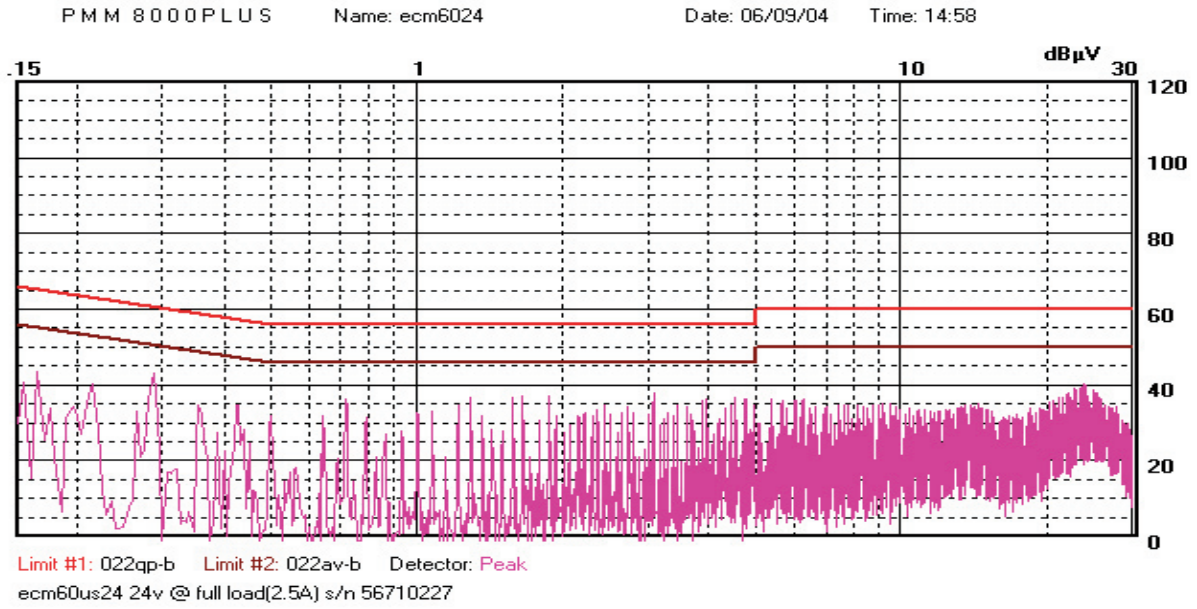

ECM60US24 at full load

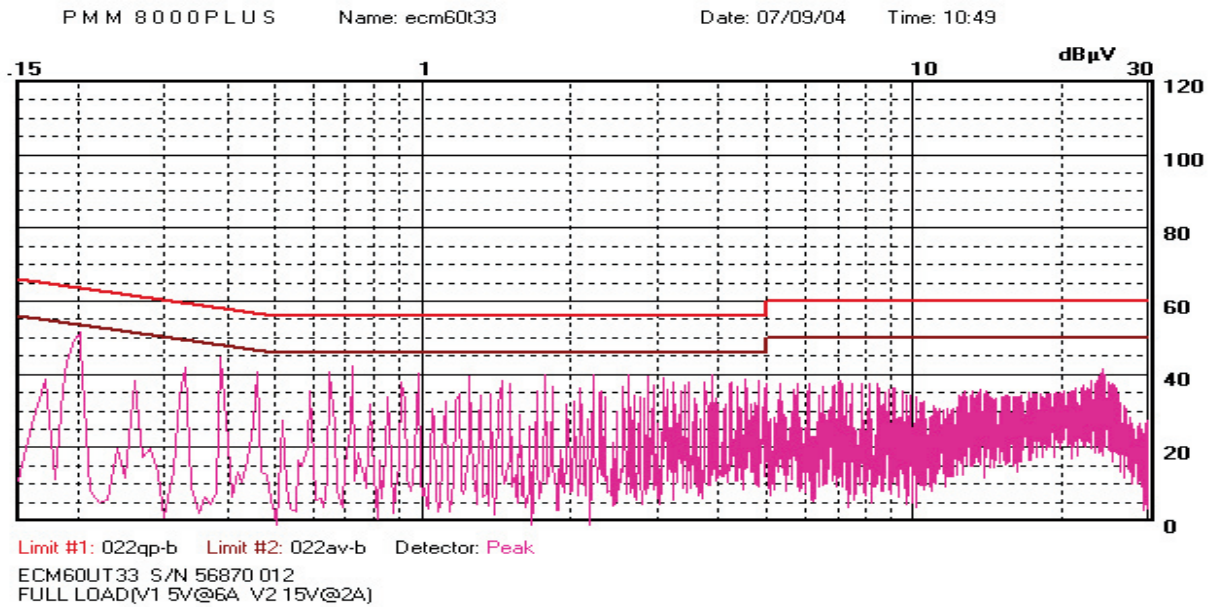

ECM60UT33 at full load

Mechanical Details - Single Output Models

Weight: approx. 0.33 lb (150g)

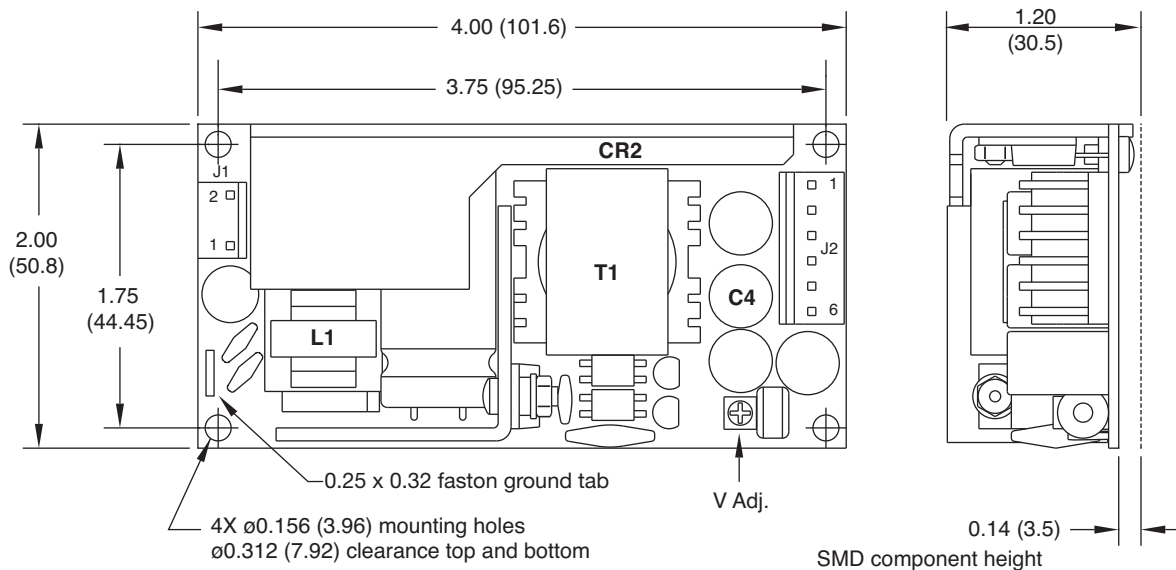

Input Connector J1	
Pin 1	Line
Pin 2	Neutral

J1 mates with Molex housing 43061-0003 and Molex series 5194 crimp terminals. Ground (0.25 faston) tab standard.

Output Connector J2	
Pin	Single
1	+V1
2	+V1
3	RTN
4	RTN
5	N.C.
6	N.C.

J2 mates with Molex housing 43061-0006 & Molex series 5194 crimp terminals.

Notes

- All dimensions in inches (mm). Tolerance .xx = ±0.02 (0.50); .xxx = ±0.01 (0.25)
- Cable harnesses with 300mm wire available.
For single output models, order part number ECM40/60S LOOM.
For multi-output models, order part number ECM40/60DT LOOM.
- Mating connector kit available. Order part number ECM40/60 CONKIT.
- Covers available. Order part number ECM40/60 COVER. Cover dimensions are 4.49 x 2.52 x 1.52 (114 x 64 x 38.5)

Thermal Considerations

To ensure correct and safe operation of the PSU, the temperature of the components listed in the table below must not be exceeded. See mechanical details for component locations.

Component	Maximum Temperature
L1	110 °C
T1	110 °C
CR2	120 °C
C4	95 °C

Mechanical Details - Single Output Models (3 x 5)

Weight: approx. 0.4 lb (180 g)

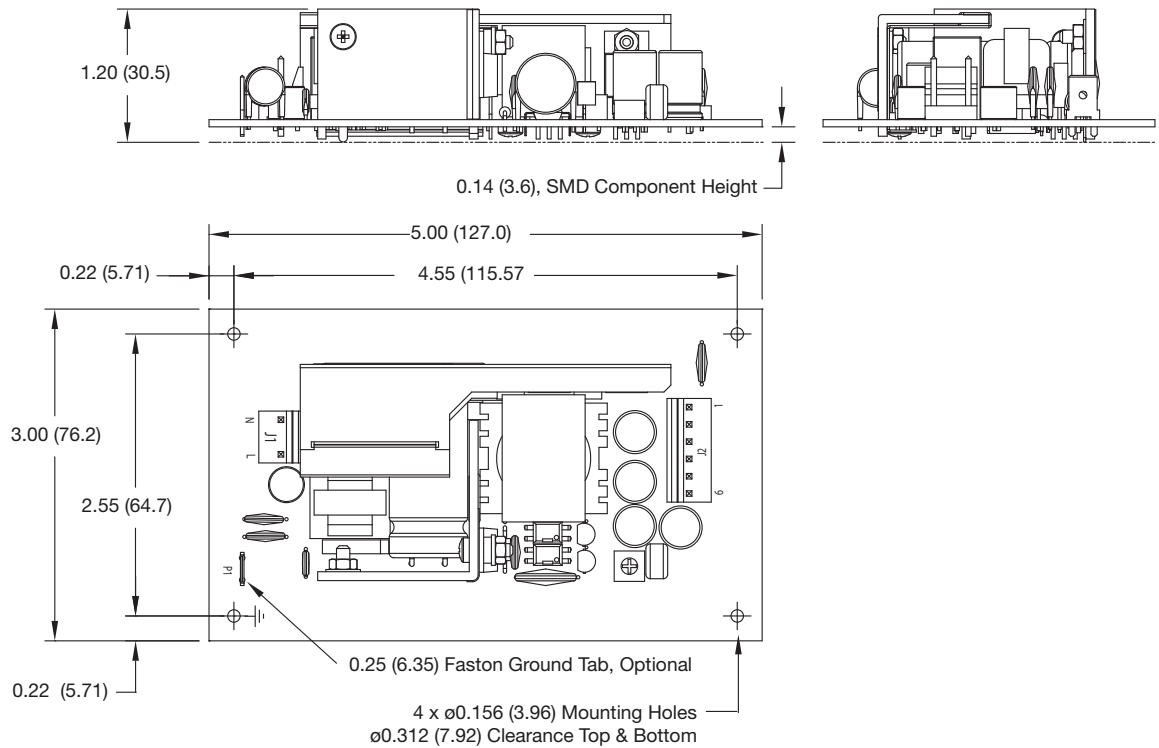

Input Connector J1	
Pin 1	Line
Pin 2	Neutral

J1 mates with Molex housing 43061-0003 and Molex series 5194 crimp terminals. Ground (0.25 faston) tab standard.

Output Connector J2	
Pin	Single
1	+V1
2	+V1
3	RTN
4	RTN
5	N.C.
6	N.C.

J2 mates with Molex housing 43061-0006 & Molex series 5194 crimp terminals.

Notes

- All dimensions in inches (mm). Tolerance .xx = ±0.02 (0.50); .xxx = ±0.01 (0.25)
- Cable harnesses with 300mm wire available.
For single output models, order part number ECM40/60S LOOM.
For multi-output models, order part number ECM40/60DT LOOM .
- Mating connector kit available. Order part number ECM40/60 CONKIT.
- Covers available. Order part number ECM40/60 COVER. Cover dimensions are 4.49 x 2.52 x 1.52 (114 x 64 x 38.5)

Thermal Considerations

To ensure correct and safe operation of the PSU, the temperature of the components listed in the table below must not be exceeded. See mechanical details for component locations.

Component	Maximum Temperature
L1	110 °C
T1	110 °C
CR2	120 °C
C4	95 °C

Mechanical Details - Multi Output Models

Weight: approx. 0.33 lb (150g)

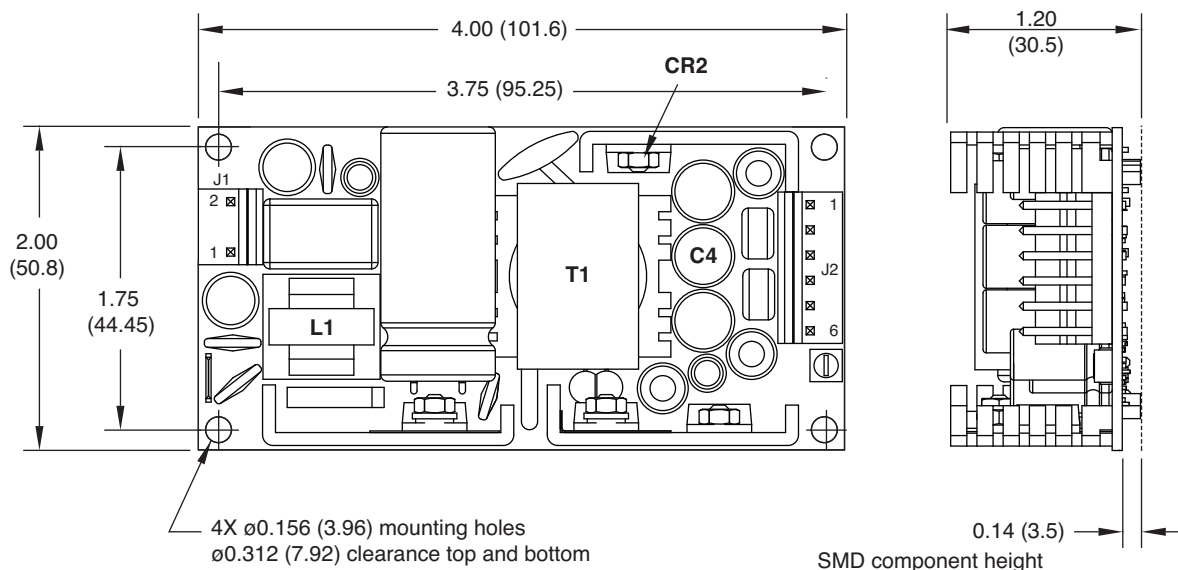

Input Connector J1	
Pin 1	Line
Pin 2	Neutral

J1 mates with Molex housing 43061-0003 and Molex series 5194 crimp terminals. Ground (0.25 faston) tab standard.

Output Connector J2	
Pin	Single
1	+V1
2	+V1
3	RTN
4	RTN
5	-V3
6	+V2

J2 mates with Molex housing 43061-0006 & Molex series 5194 crimp terminals.

Notes

- All dimensions in inches (mm). Tolerance .xx = ±0.02 (0.50); .xxx = ±0.01 (0.25)
- Cable harnesses with 300mm wire available.
For single output models, order part number ECM40/60S LOOM.
For multi-output models, order part number ECM40/60DT LOOM .
- Mating connector kit available. Order part number ECM40/60 CONKIT.
- Covers available. Order part number ECM40/60 COVER. Cover dimensions are 4.49 x 2.52 x 1.52 (114 x 64 x 38.5)

Thermal Considerations

To ensure correct and safe operation of the PSU, the temperature of the components listed in the table below must not be exceeded. See mechanical details for component locations.

Component	Maximum Temperature
L1	110 °C
T1	110 °C
CR2	120 °C
C4	95 °C

Mouser Electronics

Authorized Distributor

Click to View Pricing, Inventory, Delivery & Lifecycle Information:

[XP Power:](#)

[ECM60US12](#) [ECM60US05](#) [ECM40US07](#) [ECM40/60 COVER](#) [ECM40UD21](#) [ECM40UT35](#) [ECM60UT32](#)
[ECM60US18](#) [ECM60US07](#) [ECM40US48](#) [ECM40UD22](#) [ECM60US09](#) [ECM40US33](#) [ECM60US48](#) [ECM60US33](#)
[ECM60UT33](#) [ECM40US24](#) [ECM40US05](#) [ECM60UT31](#) [ECM40UT33](#) [ECM40UT34](#) [ECM40/60DT LOOM](#)
[ECM40UT32](#) [ECM40US18](#) [ECM60US28](#) [ECM60US12-C](#) [ECM40US12](#) [ECM40UT31](#) [ECM60US24](#) [ECM40US09](#)
[ECM60UT35](#) [ECM60US15](#) [ECM60UT34](#) [ECM40/60S LOOM](#) [ECM40/60 CONKIT](#) [ECM60UD21](#) [ECM40US15](#)
[ECM60US24-C](#)