



MIL-DTL-83513/10 Thru /15 Micro-D CBR Condensed Right Angle PCB Terminated



High Performance

These connectors feature gold-plated TwistPin contacts for best performance. PC tails are .020 inch diameter. Specify nickel-plated shells or cadmium plated shells for best availability.

Solder-Dipped

Terminals are coated with Sn60/Pb40 tin-lead solder for best solderability.

How To Order MIL-DTL-83513 Right Angle Micro-D Connectors

Sample Part Number	M83513/	13-B	02	N	P
Base Part Number	M83513				
Slash Number-Shell Sizes	Plug (Pin Contacts)		Receptacle (Socket Contacts)		
	10-A - 9 Contacts 10-B - 15 Contacts 10-C - 21 Contacts 10-D - 25 Contacts 10-E - 31 Contacts 10-F - 37 Contacts 11-G - 51 Contacts 12-H - 100 Contacts (See Table II)	13-A - 9 Contacts 13-B - 15 Contacts 13-C - 21 Contacts 13-D - 25 Contacts 13-E - 31 Contacts 13-F - 37 Contacts 14-G - 51 Contacts 15-H - 100 Contacts			
PC Tail Length	01 - .109 Inch (2.77 mm) PC Tail Length ± .015 (0.38)	02 - .140 Inch (3.56 mm)	03 - .172 Inch (4.37 mm)		
Shell Finish	C - Cadmium N - Electroless Nickel P - Passivated SST	A - Electrodeposited Aluminum K - Zinc Nickel T - Nickel Fluorocarbon Polymer			
Hardware Options	N - No Jackpost P - Jackposts Installed Sizes 9-51 T - Threaded Insert in Board Mount Hole (No Jackposts) W - Threaded Insert in Board Mount Hole and jackposts Installed Shell Size 100 (H) U - #4-40 Threaded Insert Y - #4-40 Threaded Insert & Jackpost See "Hardware Options" below for Illustrations (See Table I)				

Table I: Hardware Options

N	P	T or U	W or Y
THRU HOLE	THRU HOLE	THREADED INSERT	THREADED INSERT
No Jackpost	Jackpost	Threaded Insert	Jackpost, Threaded Insert

MIL-DTL-83513/10 Thru /15 Micro-D CBR Condensed Right Angle PCB Terminated



Micro-D
MIL-DTL-83513

Table II: Dimensions

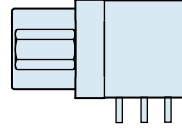

THREAD SIZES
9-51 CONTACTS #2-56 UNC
100 CONTACTS #4-40 UNC

CONFIGURATION FOR 9-25 CONTACTS

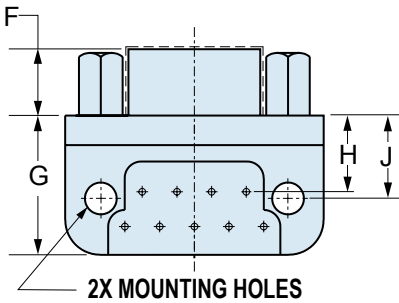

PCB MOUNTING HOLES
9-51 CONTACTS .096 DIA. $\pm .003$ (2.44 \pm 0.08)
100 CONTACTS .125 DIA. $\pm .003$ (3.18 \pm 0.08)

CONFIGURATION FOR 31-100 CONTACTS

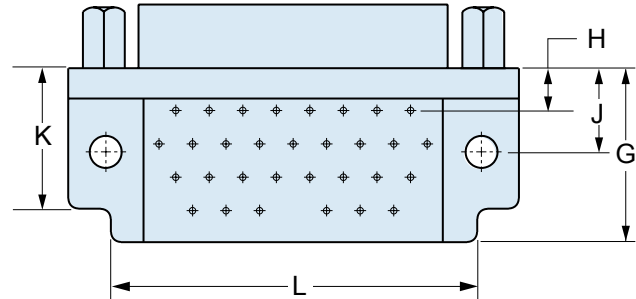

Layout	A Max.		B		C Max.		D Max.		E Max.		F		G Max.		H		J		K Max.		L Max.	
	In.	mm.	In. $\pm .003$	mm. ± 0.08	In.	mm.	In.	mm.	In.	mm.	In. $\pm .003$	mm. ± 0.08	In.	mm.	In. $\pm .010$	mm. ± 0.25	In. $\pm .010$	mm. ± 0.25	In.	mm.	In.	mm.
9P	.787	19.94	.565	14.35	.333	8.46	.184	4.67	.310	7.87	.183	4.65	.425	10.80	.230	5.84	.250	6.35	--	--	--	--
9S	.787	19.94	.565	14.35	.400	10.16	.250	6.35	.310	7.87	.195	4.95	.425	10.80	.230	5.84	.250	6.35	--	--	--	--
15P	.937	23.75	.715	18.16	.483	12.27	.184	4.67	.310	7.87	.183	4.65	.425	10.80	.130	3.30	.250	6.35	--	--	--	--
15S	.937	23.75	.715	18.16	.551	14.00	.250	6.35	.310	7.87	.195	4.95	.425	10.80	.130	3.30	.250	6.35	--	--	--	--
21P	1.087	27.56	.865	21.97	.633	16.08	.184	4.67	.310	7.87	.183	4.65	.425	10.80	.130	3.30	.250	6.35	--	--	--	--
21S	1.087	27.56	.865	21.97	.701	17.81	.250	6.35	.310	7.87	.195	4.95	.425	10.80	.130	3.30	.250	6.35	--	--	--	--
25P	1.187	30.01	.965	24.51	.733	18.62	.184	4.67	.310	7.87	.183	4.65	.425	10.80	.130	3.30	.250	6.35	--	--	--	--
25S	1.187	30.01	.965	24.51	.801	20.35	.250	6.35	.310	7.87	.195	4.95	.425	10.80	.130	3.30	.250	6.35	--	--	--	--
31P	1.337	33.91	1.115	28.32	.883	22.43	.184	4.67	.310	7.87	.183	4.65	.525	13.34	.130	3.30	.250	6.35	.450	11.43	1.085	27.56
31S	1.337	33.91	1.115	28.32	.951	24.16	.250	6.35	.310	7.87	.195	4.95	.525	13.34	.130	3.30	.250	6.35	.450	11.43	1.085	27.56
37P	1.487	37.72	1.265	32.13	1.033	26.24	.184	4.67	.310	7.87	.183	4.65	.525	13.34	.130	3.30	.250	6.35	.450	11.43	1.185	30.10
37S	1.487	37.72	1.265	32.13	1.101	27.96	.250	6.35	.310	7.87	.195	4.95	.525	13.34	.130	3.30	.250	6.35	.450	11.43	1.185	30.10
51P	1.435	36.45	1.215	30.86	.983	24.97	.228	5.79	.351	8.92	.183	4.65	.660	16.76	.150	3.81	.300	7.62	.450	11.43	1.225	31.12
51S	1.435	36.45	1.215	30.86	1.051	26.70	.296	7.52	.351	8.92	.195	4.95	.660	16.76	.150	3.81	.300	7.62	.450	11.43	1.225	31.12
100P	2.175	55.12	1.800	45.72	1.383	35.13	.270	6.86	.394	10.01	.183	4.65	1.010	25.65	.200	5.08	.400	10.16	.590	14.99	1.820	46.23
100S	2.175	55.12	1.800	45.72	1.451	36.86	.333	8.46	.394	10.01	.195	4.95	1.010	25.65	.200	5.08	.400	10.16	.590	14.99	1.820	46.23





MIL-DTL-83513/10 Thru /15 Micro-D CBR Condensed Right Angle PCB Terminated

M83513/10 Thru /12 Connector PCB Layouts – Pin Connectors

Patterns shown are for connector mounting side of PC board. 9 Thru 51 Contacts .096 (2.44) Diameter Mounting Holes, 100 Pin .125 (3.18) Diameter

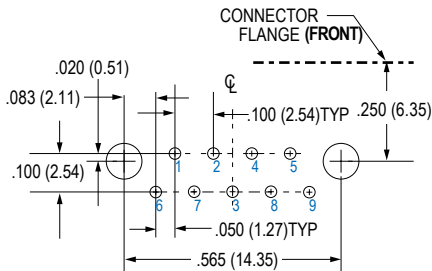

9 PIN M83513/10-A

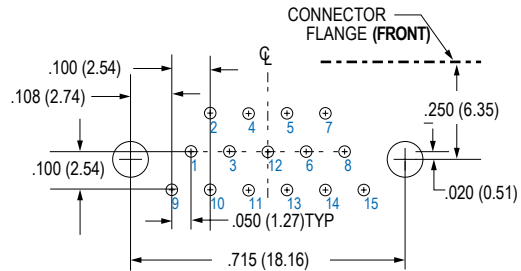

15 PIN M83513/10-B

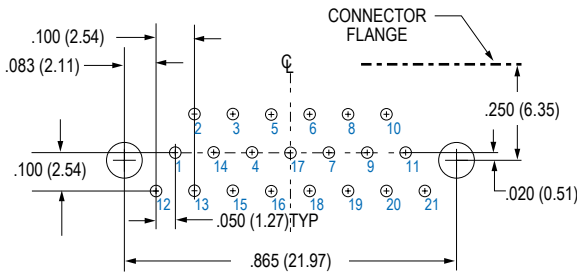

21 PIN M83513/10-C

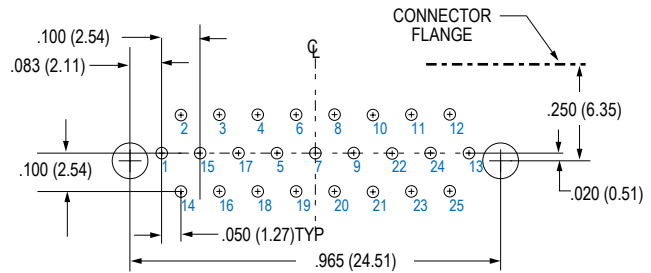

25 PIN M83513/10-D

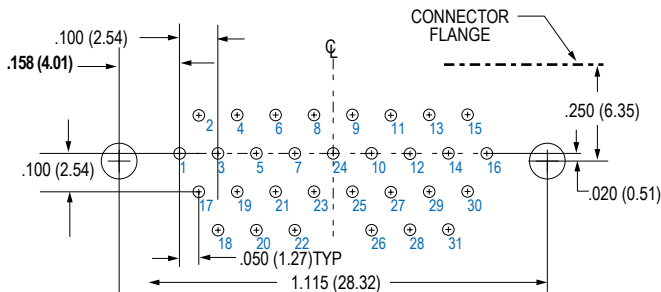

31 PIN M83513/10-E

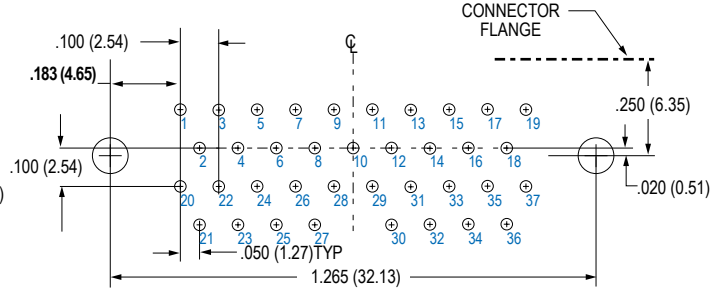

37 PIN M83513/10-F

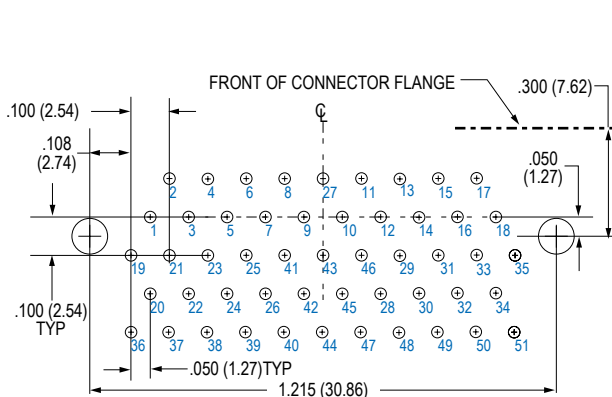

51 PIN M83513/11-G

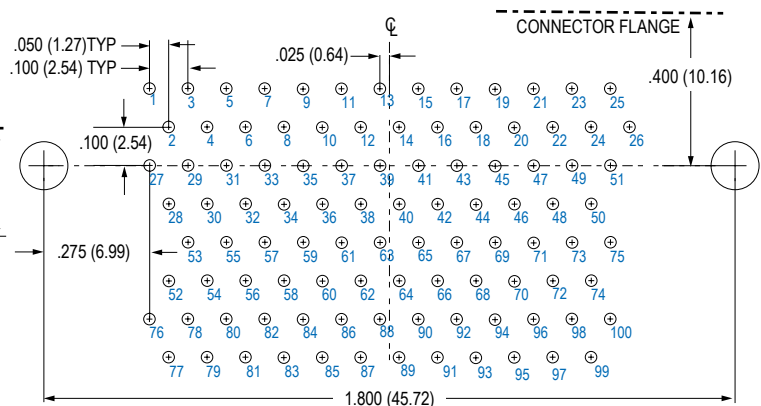

100 PIN M83513/12-H

M83513/13 THRU /15 connector PCB Layouts – Socket Connectors

Patterns shown are for connector mounting side of PC board. 9 Thru 51 Contacts .096 (2.44) Diameter Mounting Holes, 100 Pin .125 (3.18) Diameter

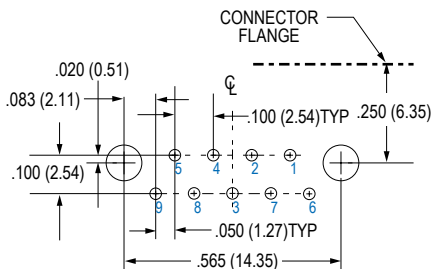

9 SOCKET M83513/13-A

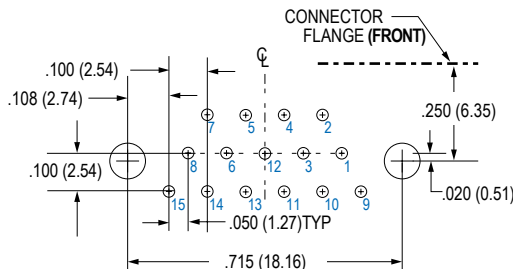

15 SOCKET M83513/13-B

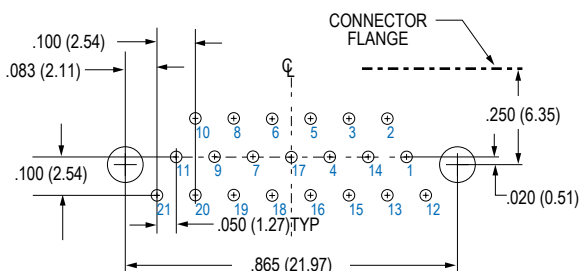

21 SOCKET M83513/13-C

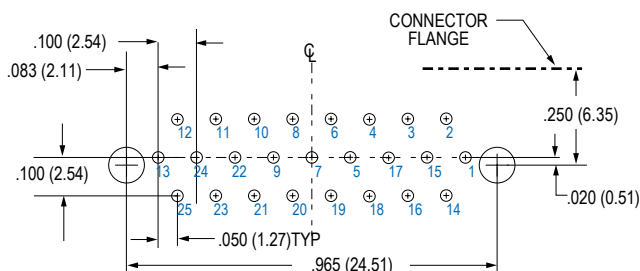

25 SOCKET M83513/13-D

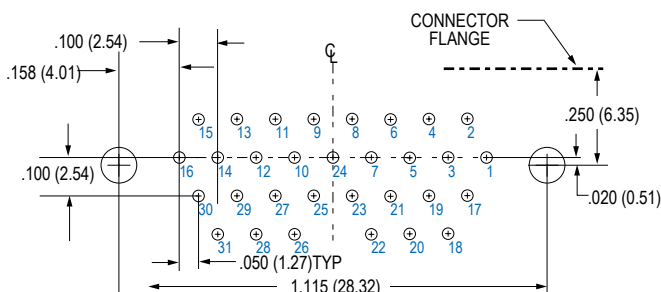

31 SOCKET M83513/13-E

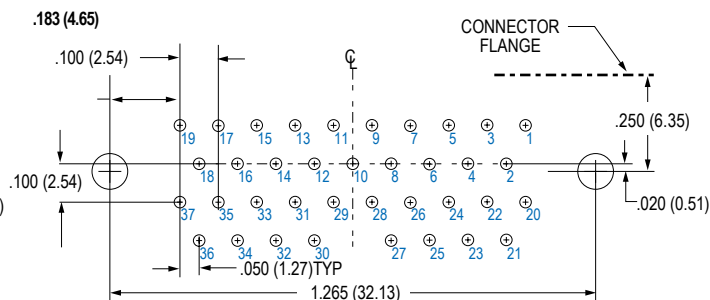

37 SOCKET M83513/13-F

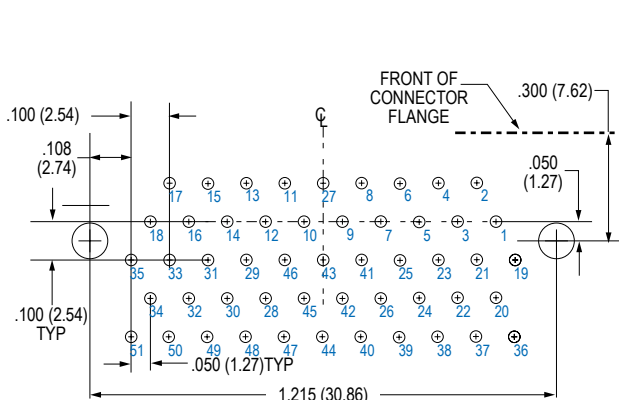

51 SOCKET M83513/14-G

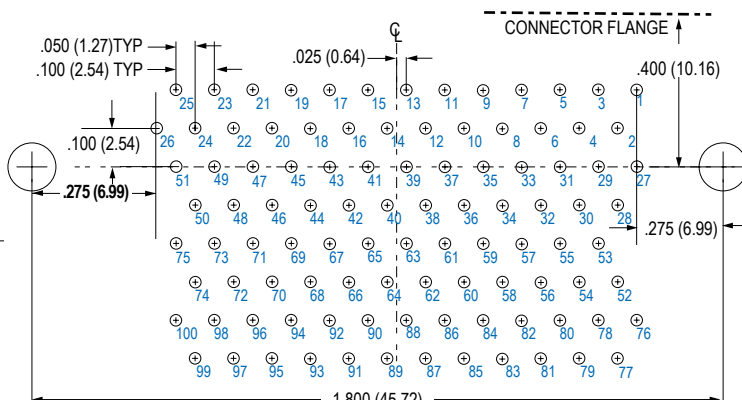

100 SOCKET M83513/15-H

Mouser Electronics

Authorized Distributor

Click to View Pricing, Inventory, Delivery & Lifecycle Information:

Glenair:

[M83513/04-H04N](#) [M83513/15-H01NN](#) [M83513/03-H04C](#) [M83513/03-B14N](#) [M83513/10-B01PW](#) [M83513/13-E02CP](#)
[M83513/13-F01NP](#) [M83513/10-B02CT](#) [M83513/13-B02CT](#) [M83513/13-D02NP](#) [M83513/04-A05N](#) [M83513/11-](#)
[G02CP](#) [M83513/14-G01NP](#) [M83513/10-D02CP](#) [M83513/13-B01CN](#) [M83513/13-A02CN](#) [M83513/15-H03CP](#)
[M83513/03-H16N](#) [M83513/04-G07N](#) [M83513/14-G02NW](#) [M83513/13-C03CN](#) [M83513/13-C03CT](#) [M83513/13-](#)
[C03CW](#) [M83513/13-C03NN](#) [M83513/13-C03NP](#) [M83513/13-C03NT](#) [M83513/13-C03NW](#) [M83513/13-C03PN](#)
[M83513/13-C03PP](#) [M83513/13-C03PT](#) [M83513/13-C03PW](#) [M83513/13-CO1CP](#) [M83513/13-D01CT](#) [M83513/13-](#)
[D01CW](#) [M83513/13-D01NT](#) [M83513/13-D01NW](#) [M83513/13-D01PN](#) [M83513/13-D01PP](#) [M83513/13-D01PT](#)
[M83513/13-D01PW](#) [M83513/13-D02CN](#) [M83513/13-D02CP](#) [M83513/13-D02CT](#) [M83513/13-D02CW](#) [M83513/13-](#)
[D02NN](#) [M83513/13-D02NT](#) [M83513/13-D02NW](#) [M83513/13-D02PN](#) [M83513/13-D02PP](#) [M83513/13-D02PT](#)
[M83513/13-D02PW](#) [M83513/13-D03CN](#) [M83513/13-D03CT](#) [M83513/13-D03CW](#) [M83513/13-D03NN](#) [M83513/13-](#)
[D03NP](#) [M83513/13-D03NT](#) [M83513/13-D03NW](#) [M83513/13-D03PN](#) [M83513/13-D03PP](#) [M83513/13-D03PT](#)
[M83513/13-D03PW](#) [M83513/13-E01CT](#) [M83513/13-E01CW](#) [M83513/13-E01NT](#) [M83513/13-E01NW](#) [M83513/13-](#)
[E01PN](#) [M83513/13-E01PP](#) [M83513/13-E01PT](#) [M83513/13-E01PW](#) [M83513/13-E02CN](#) [M83513/13-E02CT](#)
[M83513/13-E02CW](#) [M83513/13-E02NN](#) [M83513/13-E02NP](#) [M83513/13-E02NT](#) [M83513/13-E02PN](#) [M83513/13-](#)
[E02PP](#) [M83513/13-E02PT](#) [M83513/13-E02PW](#) [M83513/13-E03CN](#) [M83513/13-E03CP](#) [M83513/13-E03CT](#)
[M83513/13-E03CW](#) [M83513/13-E03NN](#) [M83513/13-E03NT](#) [M83513/13-E03NW](#) [M83513/13-E03PN](#) [M83513/13-](#)
[E03PP](#) [M83513/13-E03PT](#) [M83513/13-E03PW](#) [M83513/13-F01CT](#) [M83513/13-F01CW](#) [M83513/13-F01NT](#)
[M83513/13-F01NW](#) [M83513/13-F01PN](#) [M83513/13-F01PP](#) [M83513/13-F01PT](#) [M83513/13-F01PW](#) [M83513/13-](#)
[F02CN](#)