

Product Overview

The CMD241P4 is wideband GaAs MMIC distributed low noise amplifier housed in a leadless 4x4 mm surface mount package. The amplifier operates from 2 to 22 GHz and delivers greater than 13 dB of gain with a corresponding noise figure of 2.3 dB and an output 1 dB compression point of +21 dBm at 11 GHz. The CMD241P4 is a 50 ohm matched design which eliminates the need for external DC blocks and RF port matching.

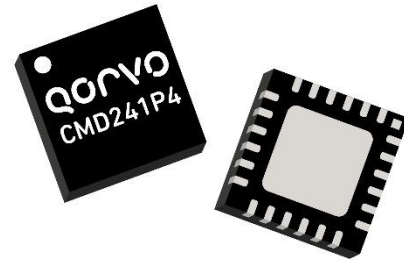

Functional Block Diagram

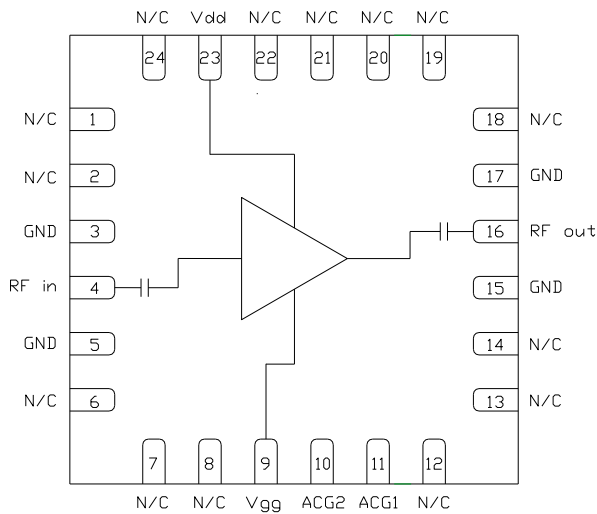

Key Features

- Ultra Wideband Performance
- Low Noise Figure
- Low Current Consumption
- Excellent Return Losses
- Pb-Free RoHs Compliant 4x4 QFN Package

Ordering Information

Part No.	Description
CMD241P4	100 Piece 7" Reel
CMD241P4-EVB	1 Piece Bag

Electrical Performance ($V_{dd} = 5.0\text{ V}$, $I_{dd} = 74\text{ mA}$, $T_A = 25^\circ\text{C}$, $F = 11\text{ GHz}$)

Parameter	Min	Typ	Max	Units
Frequency Range		2 - 22		GHz
Gain		13.5		dB
Noise Figure		2.3		dB
Input Return Loss		18		dB
Output Return Loss		15		dB
Output P1dB		21		dBm
Output IP3		28		dBm
Output IP2		37		dBm
Supply Current		74		mA

Absolute Maximum Ratings

Parameter	Rating
Drain Voltage, V_{dd}	10 V
Gate Voltage, V_{gg}	-2.5 to 0 V
RF Input Power	+20 dBm
Channel Temperature, T_{ch}	150° C
Power Dissipation, P_{diss}	1.75 W
Thermal Resistance Q_{jC}	37° C/W
Operating Temperature	-40 to 85° C
Storage Temperature	-55 to 150° C

Exceeding any one or combination of the maximum ratings may cause permanent damage to the device.

Recommended Operating Conditions

Parameter	Min	Typ	Max	Units
V_{dd}	5.0	5.0	8.0	V
I_{dd}		74		mA
V_{gg}		-0.65		V

Electrical performance is measured at specific test conditions. Electrical specifications are not guaranteed over all recommended operating conditions.

Electrical Specifications ($V_{dd} = 5.0$ V, $I_{dd} = 74$ mA, $T_A = 25^\circ$ C)

Parameter	Min	Typ	Max	Min	Typ	Max	Min	Typ	Max	Units
Frequency Range	2 - 6			6 - 18			18 - 22			GHz
Gain	10	13		10.5	13.5		11	14.5		dB
Noise Figure		3.5			2.5			3.75		dB
Input Return Loss		12			13			15		dB
Output Return Loss		15			15			9		dB
Output P1dB	16	20		14	18		14	17		dBm
Output IP3		29			28			25		dBm
Output IP2		38			38			45		dBm
Supply Current	50	74	100	50	74	100	50	74	100	mA
Gain Temperature Coefficient		0.007			0.009			0.016		dB/°C
Noise Figure Temperature Coefficient		0.01			0.009			0.014		dB/°C

Typical Performance

Broadband Performance, $V_{dd} = 5.0$, $I_{dd} = 74$ mA, $T_A = 25^\circ$ C

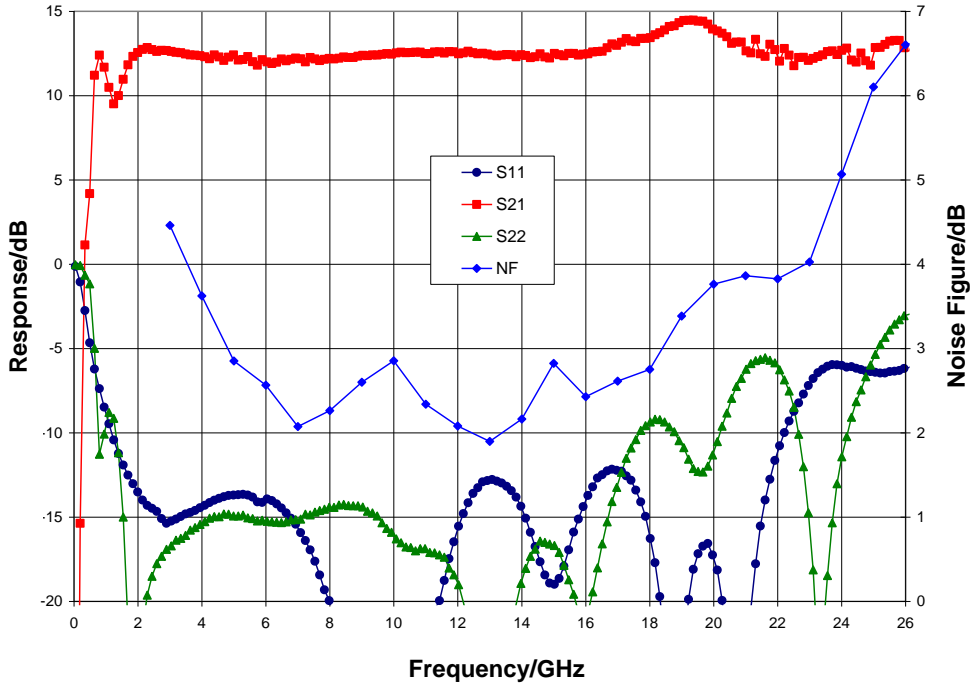

Narrow-band Performance, $V_{dd} = 5.0$ V, $I_{dd} = 74$ mA, $T_A = 25$

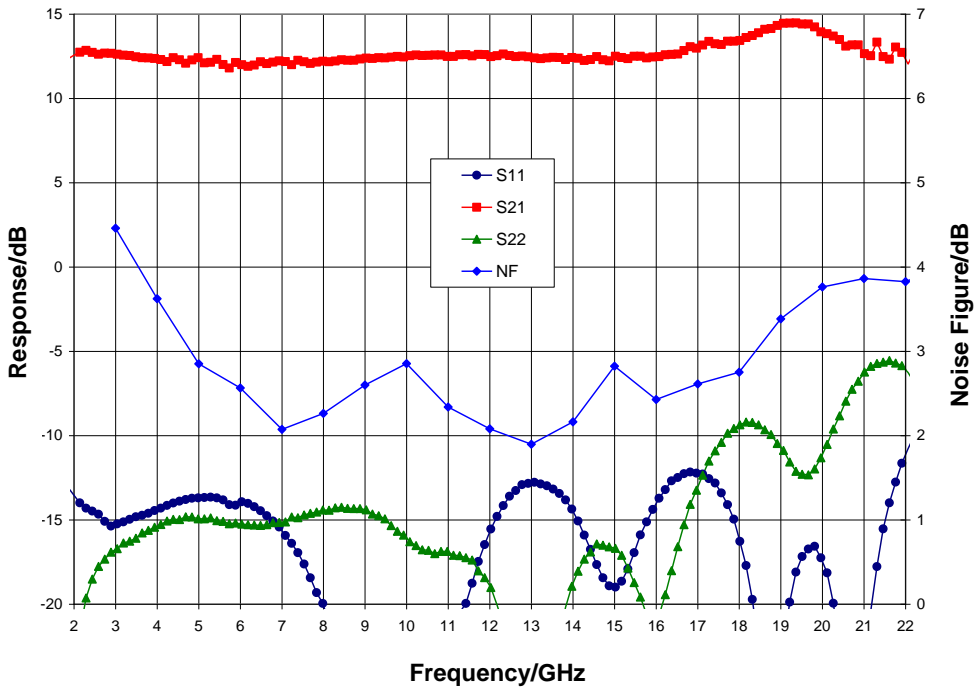

Typical Performance

Gain vs. Temperature, $V_{dd} = 5.0\text{ V}$, $I_{dd} = 74\text{mA}$

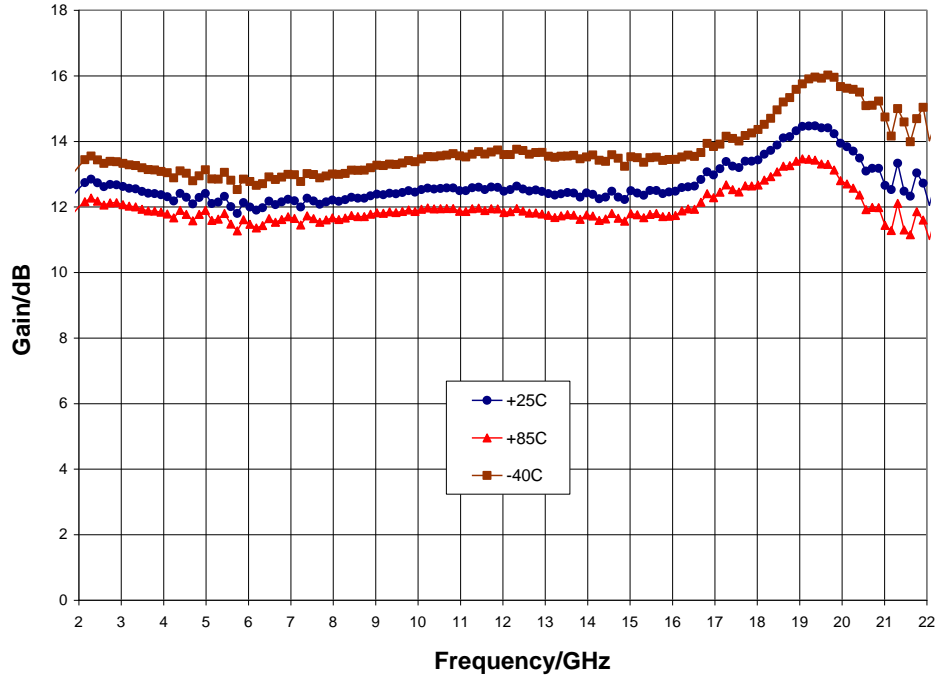

Noise Figure vs. Temperature, $V_{dd} = 5.0\text{ V}$, $I_{dd} = 74\text{mA}$

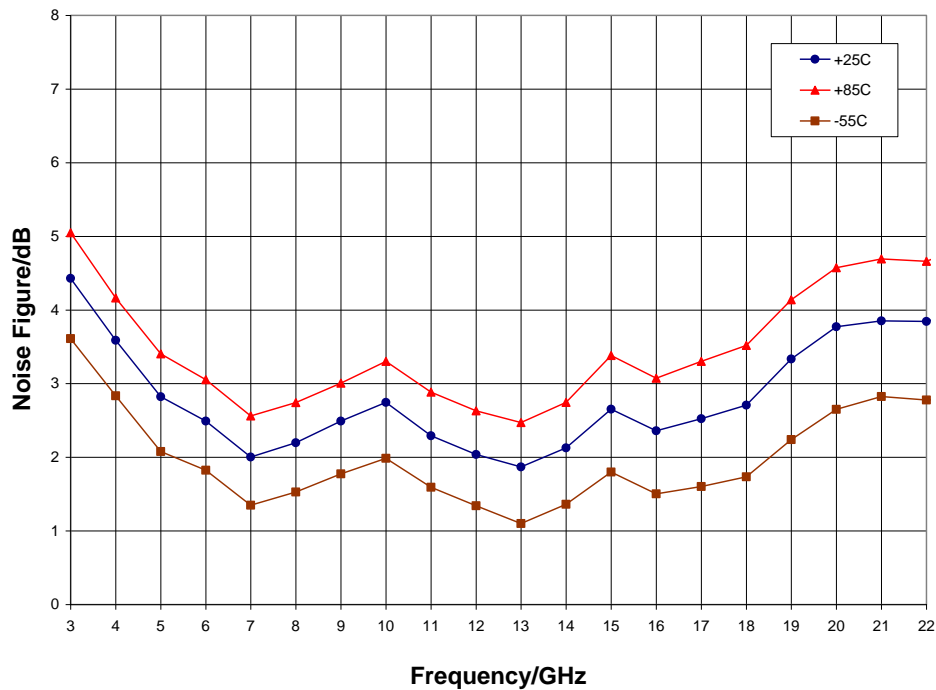

Typical Performance

Output Power, $V_{dd} = 5.0 \text{ V}$, $I_{dd} = 74\text{mA}$, $T_A = 25^\circ \text{C}$

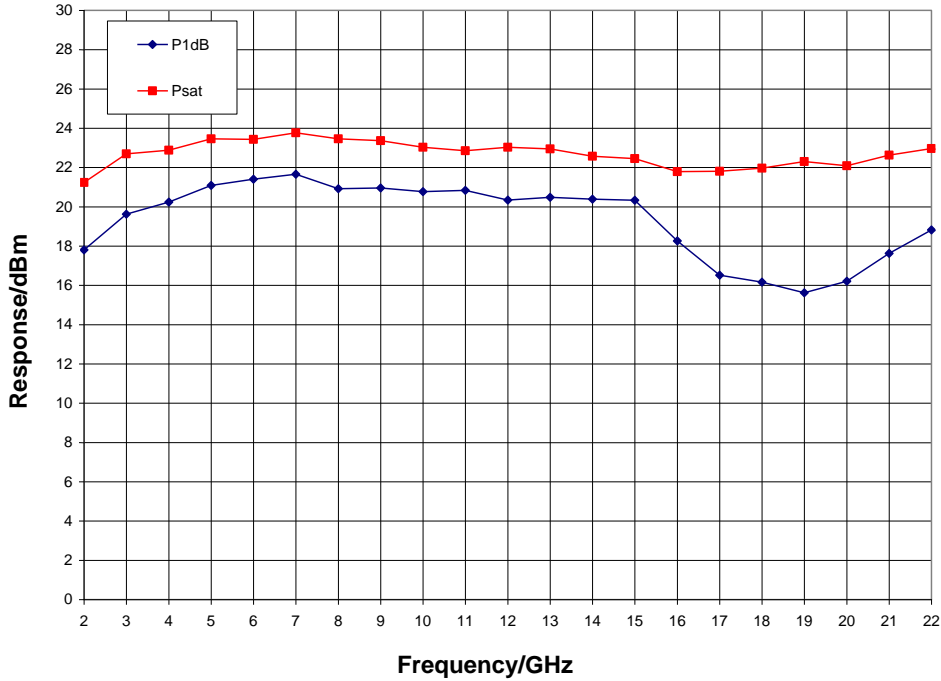

P1dB vs. Temperature, $V_{dd} = 5.0 \text{ V}$, $I_{dd} = 74\text{mA}$

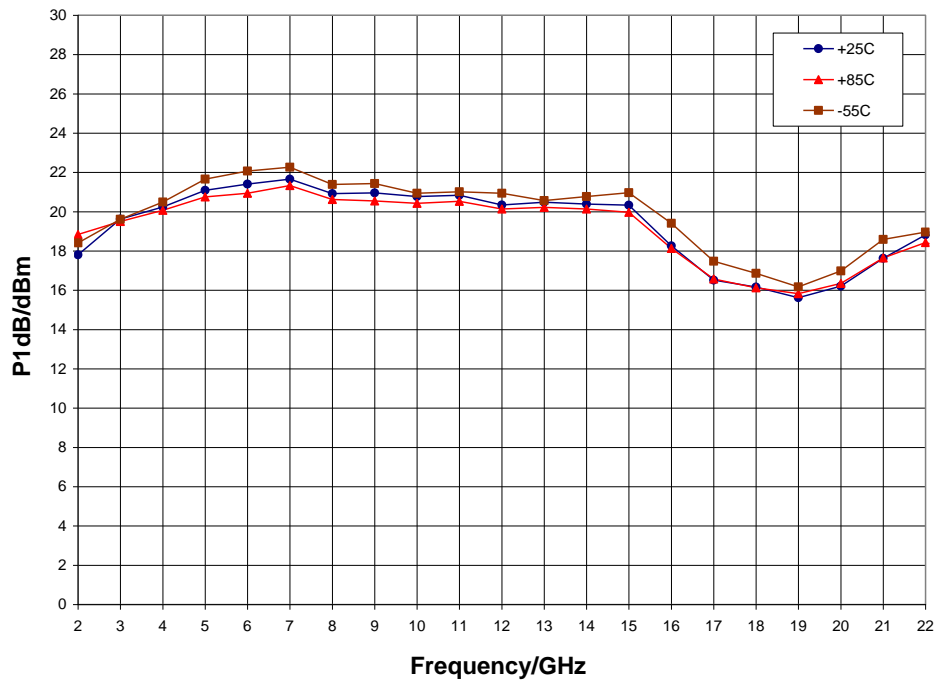

Typical Performance

Output IP3 vs. Temperature, $V_{dd} = 5.0\text{ V}$, $I_{dd} = 74\text{ mA}$

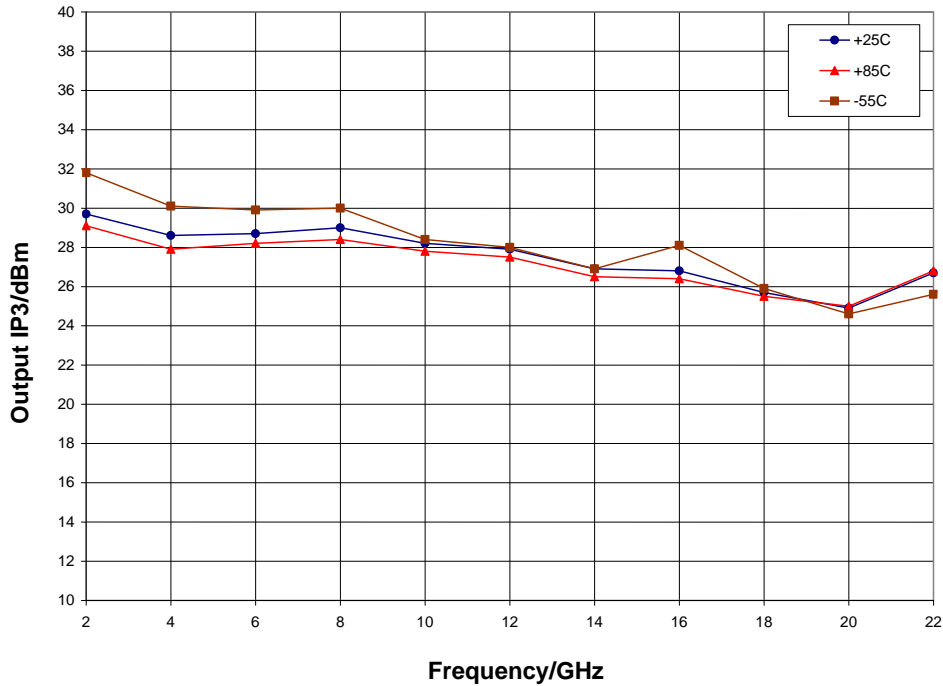

Output IP2, $V_{dd} = 5.0\text{ V}$, $I_{dd} = 74\text{ mA}$, $T_A = 25^\circ\text{ C}$

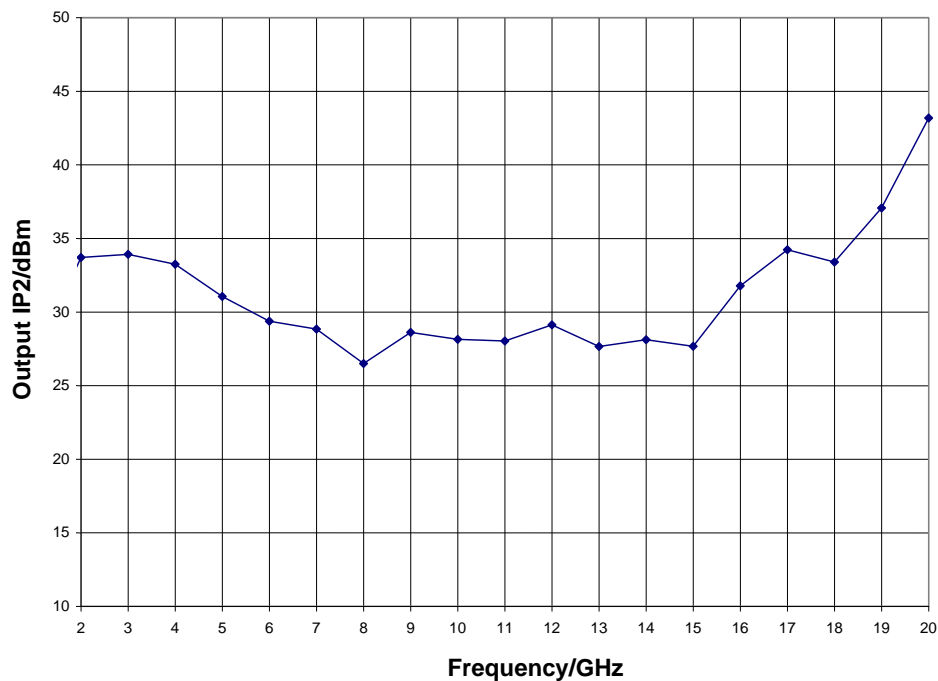

Mechanical Information

Package Information and Dimensions

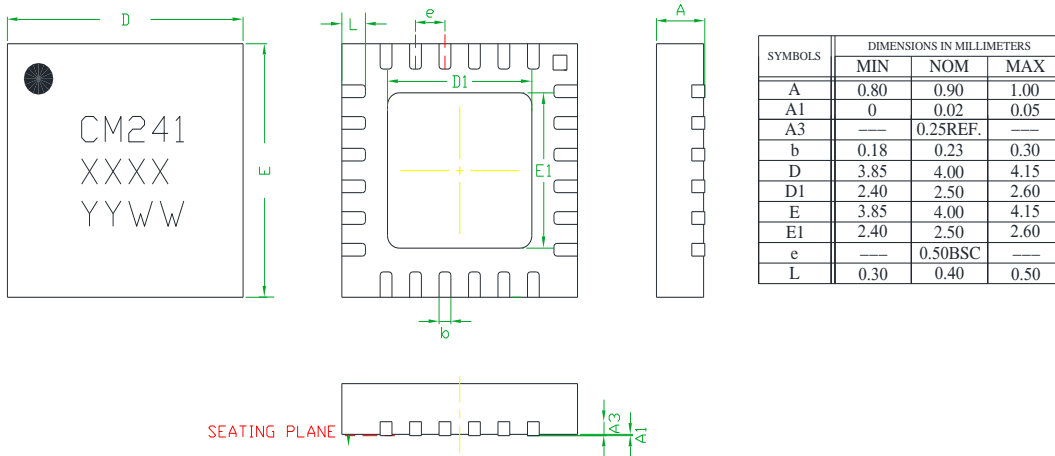

Notes:

1. Dimensions are in millimeters
2. RoHs compliant mold compound
3. Lead frame material: Copper alloy
4. Lead finish: 100% matte Sn
5. Indicated dimension/tolerance applies to leads and exposed pads

Recommended PCB Land Pattern

Qorvo recommends that the user develop the land pattern that will provide the best design for proper solder reflow and device attach for their specific application. Please review Qorvo Application Note AN 105 for a recommended land pattern approach.

Recommended Solder Reflow Profile

Qorvo recommends screen printing with belt furnace reflow to ensure proper solder reflow and device attach. Please review Qorvo Application Note AN 102 for a recommended solder reflow profile.

Pin Description

Pin Diagram

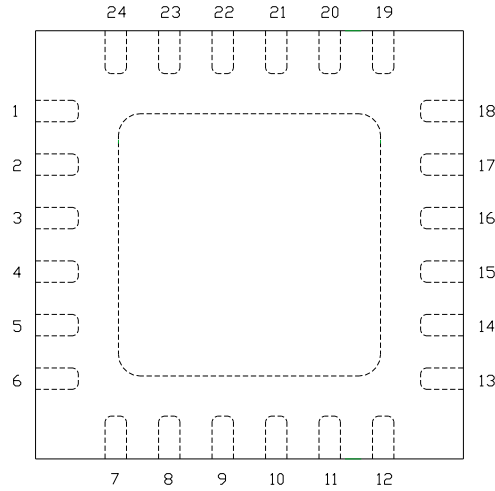

Functional Description

Pad	Function	Description	Schematic
1, 2, 6 - 8, 12 - 14, 18 - 22, 24	N/C	No connection required These pins may be connected to RF / DC ground	
4	RF in	DC blocked and 50 ohm matched	
9	V _{gg}	Power supply voltage Decoupling and bypass caps required	
10, 11	ACG2, 1	Low frequency termination Attach bypass capacitor per application circuit	
16	RF out	DC blocked and 50 ohm matched	
23	V _{dd}	Power supply voltage Decoupling and bypass caps required	
3, 5, 15, 17 and die paddle	Ground	Connect to RF / DC ground	

Applications Information

Evaluation Board

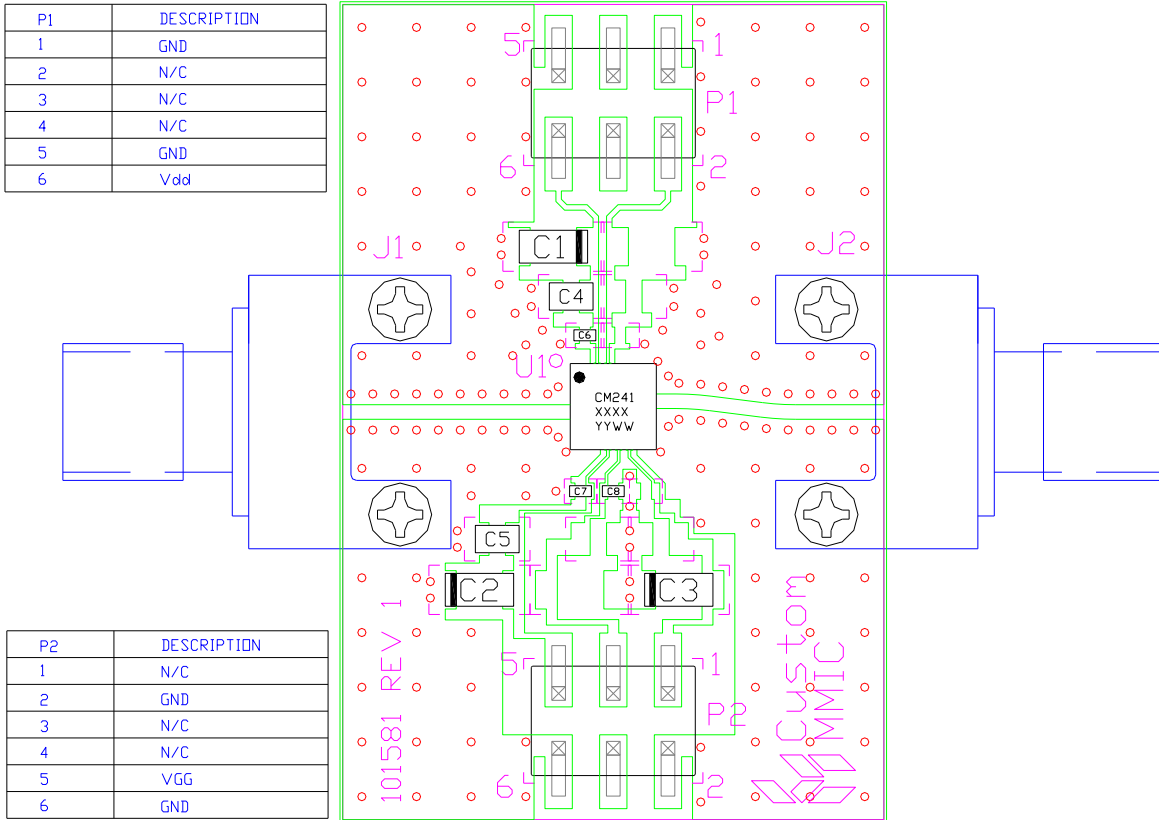

Bill of Material

Designator	Value	Description
J1, J2		SMA End Launch Connector
P1, P2		6 Pin DC Header
C1 - C3	0.33 μ F	Capacitor, Tantalum
C4, C5	1000 pF	Capacitor, 0603
C6 - C8	100 pF	Capacitor, 0402
U1		CMD241P4 Driver Amplifier
PCB		101581 Evaluation PCB

Applications Information

Application Circuit

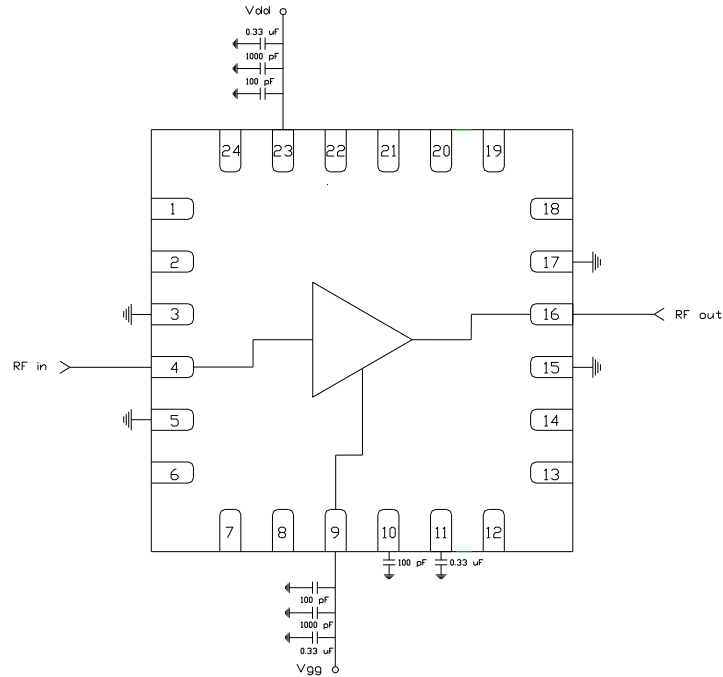

Biasing and Operation

The CMD241P4 is biased with a positive drain supply and a negative gate supply. Performance is optimized when the drain voltage is set to +5.0 V. The nominal gate voltage is -0.65 V.

Turn ON procedure:

1. Apply gate voltage V_{gg} and set to -2 V
2. Apply drain voltage V_{dd} and set to +5 V
3. Increase V_{gg} (less negative) to achieve a drain current of 74 mA

Turn OFF procedure:

1. Turn off gate voltage V_{dd}
2. Turn off drain voltage V_{gg}

RF power can be applied at any time.

GaAs MMIC devices are susceptible to damage from Electrostatic Discharge. Proper precautions should be observed during handling, assembly and test.

Handling Precautions

Parameter	Rating	Standard
ESD – Human Body Model (HBM)	Class 1A	ESDA / JEDEC JS-001-2012
MSL – Moisture Sensitivity Level	Level 1	JEDEC standard IPC/JEDEC J-STD-020



Caution!
ESD-Sensitive Device

RoHS Compliance

This part is compliant with 2011/65/EU RoHS directive (Restrictions on the Use of Certain Hazardous Substances in Electrical and Electronic Equipment) as amended by Directive 2015/863/EU.

This product also has the following attributes:

- Lead Free
- Antimony Free
- TBBP-A (C₁₅H₁₂Br₄O₂) Free
- SVHC Free
- Halogen Free
- PFOS Free

Contact Information

For the latest specifications, additional product information, worldwide sales and distribution locations:

Web: www.qorvo.com

Tel: 1-844-890-8163

Email: customer.support@qorvo.com

Important Notice

The information contained in this Data Sheet and any associated documents (“Data Sheet Information”) is believed to be reliable; however, Qorvo makes no warranties regarding the Data Sheet Information and assumes no responsibility or liability whatsoever for the use of said information. All Data Sheet Information is subject to change without notice. Customers should obtain and verify the latest relevant Data Sheet Information before placing orders for Qorvo® products. Data Sheet Information or the use thereof does not grant, explicitly, implicitly or otherwise any rights or licenses to any third party with respect to patents or any other intellectual property whether with regard to such Data Sheet Information itself or anything described by such information.

DATA SHEET INFORMATION DOES NOT CONSTITUTE A WARRANTY WITH RESPECT TO THE PRODUCTS DESCRIBED HEREIN, AND QORVO HEREBY DISCLAIMS ANY AND ALL WARRANTIES WITH RESPECT TO SUCH PRODUCTS WHETHER EXPRESS OR IMPLIED BY LAW, COURSE OF DEALING, COURSE OF PERFORMANCE, USAGE OF TRADE OR OTHERWISE, INCLUDING THE IMPLIED WARRANTIES OF MERCHANTABILITY AND FITNESS FOR A PARTICULAR PURPOSE. Without limiting the generality of the foregoing, Qorvo® products are not warranted or authorized for use as critical components in medical, life-saving, or life-sustaining applications, or other applications where a failure would reasonably be expected to cause severe personal injury or death. Applications described in the Data Sheet Information are for illustrative purposes only. Customers are responsible for validating that a particular product described in the Data Sheet Information is suitable for use in a particular application.

© 2022 Qorvo US, Inc. All rights reserved. This document is subject to copyright laws in various jurisdictions worldwide and may not be reproduced or distributed, in whole or in part, without the express written consent of Qorvo US, Inc. | QORVO® is a registered trademark of Qorvo US, Inc.