

GaAs MMIC High Dynamic Range Mixer

MT3-0113HCQG

Page 1

The MT3-0113HCQG is a triple balanced passive diode GaAs MMIC mixer offering high dynamic range, low conversion loss, and excellent repeatability. As with all T3 mixers, this mixer offers unparalleled nonlinear performance in terms of IIP3, P_{1dB}, and spurious performance with a flexible LO drive requirement from +16 dBm to +24 dBm. The MT3-0113HCQG is available in a surface-mount outline, or in an SMA connectorized evaluation fixture. The MT3-0113HCQG is a superior alternative to Marki Microwave carrier and packaged T3 mixers, and is form-fit compatible with legacy T3's in the CQ and CQG footprints. For a list of recommended LO driver amps for all mixers and IQ mixers, see [here](#).

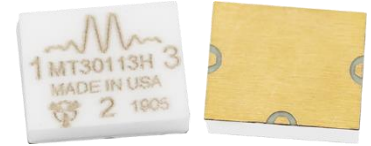

Features

- Form-Fit Compatible with Legacy CQ and CQG T3 Mixers
- Broadband, Overlapping RF, LO and IF
- Suitable for Up or Down Conversion
- Compatible with Sine or Square-Wave LO
- Square-Wave LO delivers Industry-Leading Spurious, IP3, and P_{1dB} Performance
- Application Note: [T3 Mixer Primer](#)

Electrical Specifications - Specifications guaranteed over -40 to +100°C temperature range, measured in a 50Ω system. Specifications are shown for Configurations A (B). See page 2 for port locations. Consult factory for more information.

Parameter	LO (GHz)	RF (GHz)	IF (GHz)	Min	Typ	Max	LO drive level (dBm)
Conversion Loss (dB) ¹	1.5-13	1.5-13	0.01-0.5		7.5 (7.5)	10.5	+20 (+20)
					10 (10)		
Isolation (dB)					See Plots		
LO-RF LO-IF RF-IF							
Input 1 dB Compression (dBm) ²			0.01-7		See Plots		Config. A: +16 to +24 Config. B: +16 to +24
Input Two-Tone Third Order Intercept Point (dBm) ³					+30		Config. A: +16 to +24
					+29		Config. B: +16 to +24

¹Unless otherwise specified, Conversion Loss and Spurious data is measured with a 100 MHz fixed IF.

²P_{1dB} is typically within 1-2 dB of LO drive power.

³The typical value is for a +20 dBm Sine-Wave LO. IP3 is dependent on LO drive and waveform. See plots and data sheet notes on page 10 for more details.

Part Number Options

Model Number	Description
MT3-0113HCQG-2 ¹	RoHS Compliant Surface Mount, IF Port Configuration -2
EVAL-MT3-0113H	Connectorized Evaluation Fixture

¹Note: For port locations and I/O designations, refer to the drawings on page 2 of this document.

GaAs MMIC High Dynamic Range Mixer

MT3-0113HCQG

Page 2

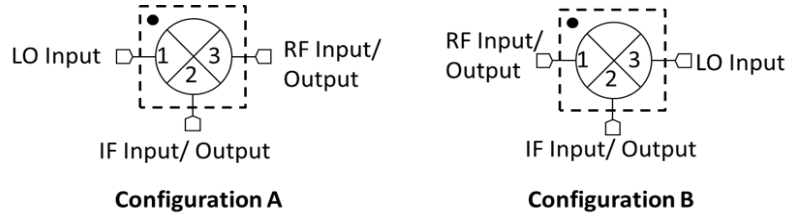

1. Configuration A/B refer to the same part number (MT3-0113HCQG) used in one of two different ways for optimal spurious performance. For the lowest conversion loss, use the mixer in Configuration A (port 1 as the LO input, port 3 as the RF input or output). If you need to use a lower LO drive, use the mixer in Configuration B (port 1 as the RF input or output, port 3 as the LO input). For optimal spurious suppression, experimentation or simulation is required to choose between Configuration A and B. For more information, [see here](#).

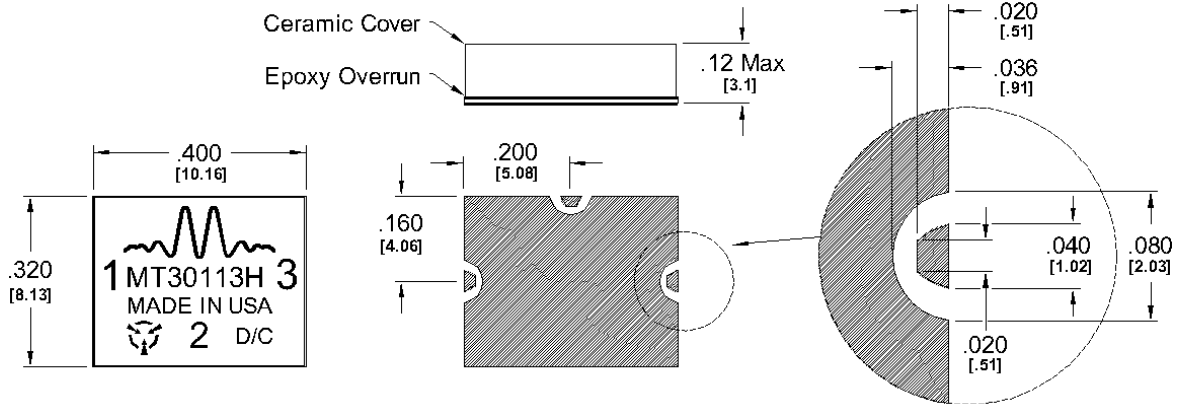

I/O Connections & Ground Plane Finish is Gold Flash, 5 to 10 μ -inches, over Solderable Nickel, 100-200 μ -inches, over Cu.

Outline Drawing – CQG-2 Package

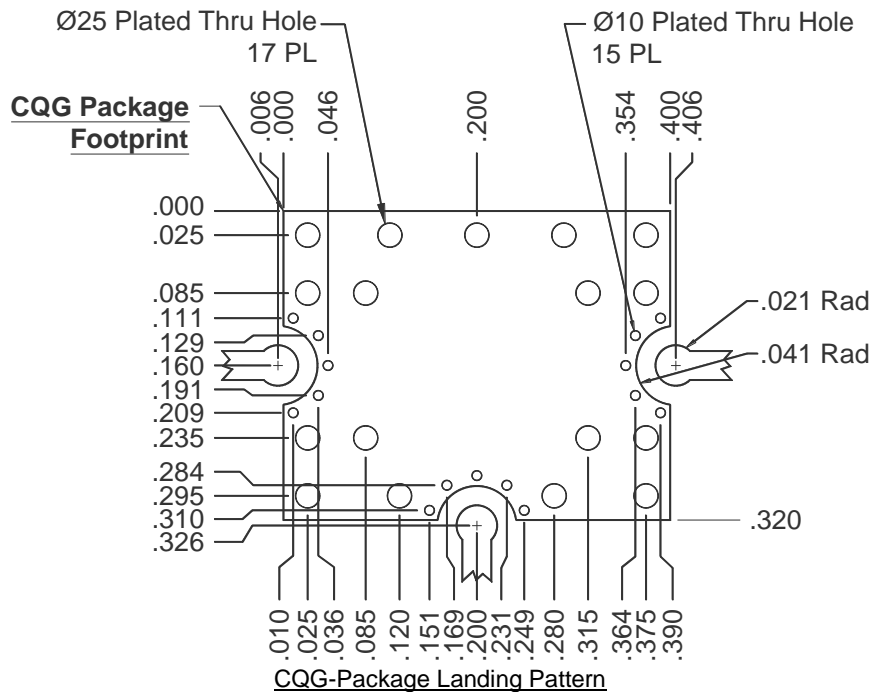

[Click here for a DXF of the above layout.](#)

[Click here for leaded solder reflow.](#) [Click here for lead-free solder reflow.](#)

GaAs MMIC High Dynamic Range Mixer

MT3-0113HCQG

Page 3

Typical Performance

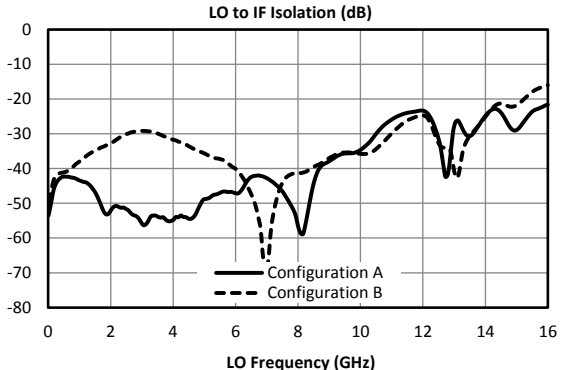
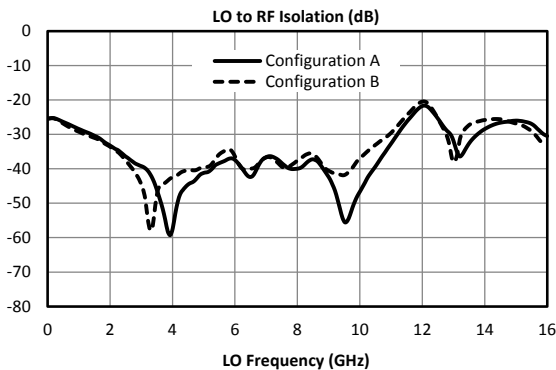
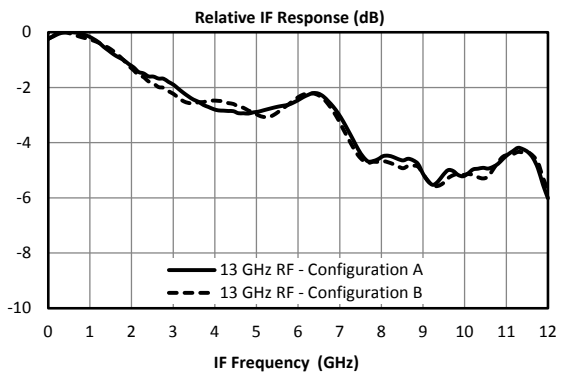
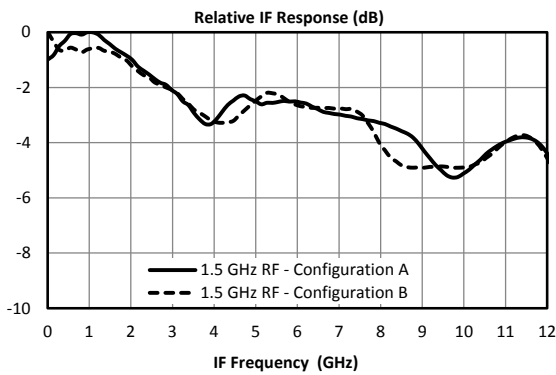
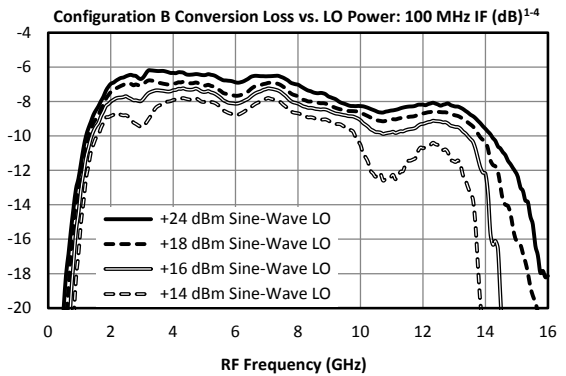
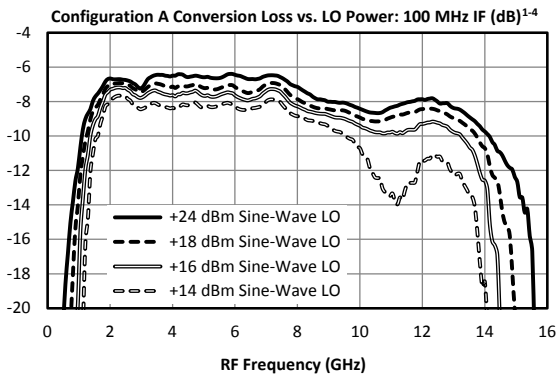
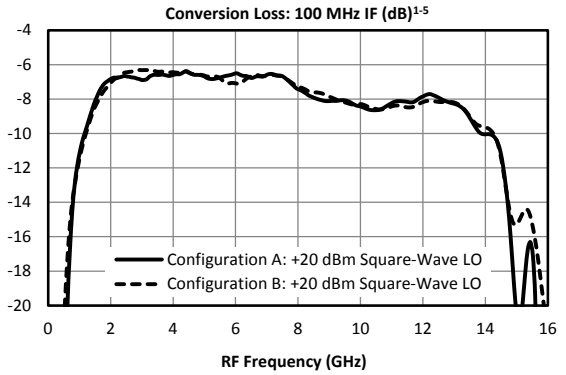
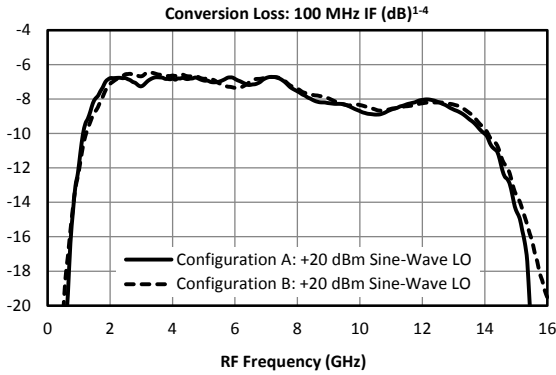

GaAs MMIC High Dynamic Range Mixer

MT3-0113HCQG

Page 4

Typical Performance

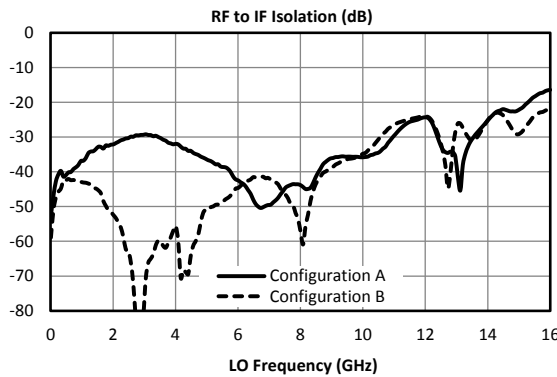
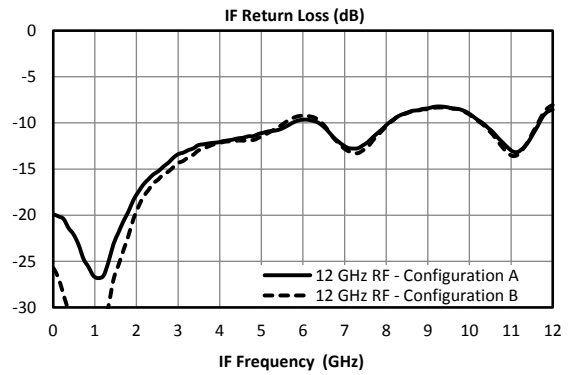
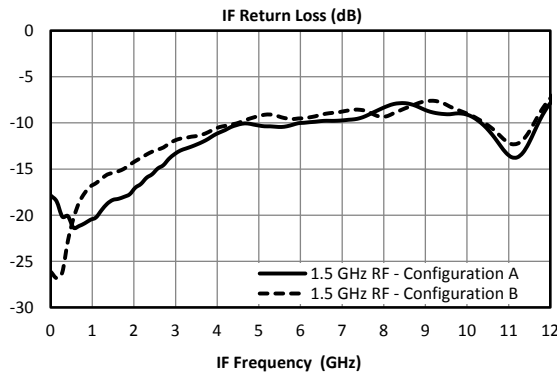
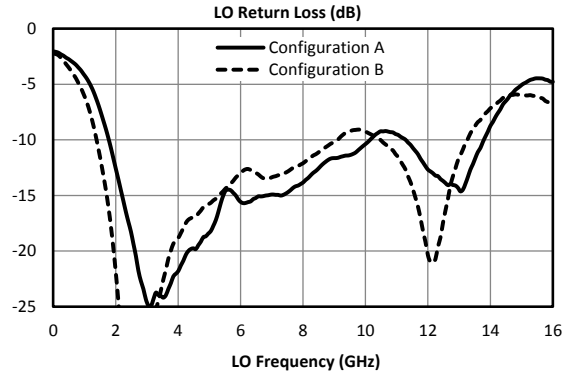
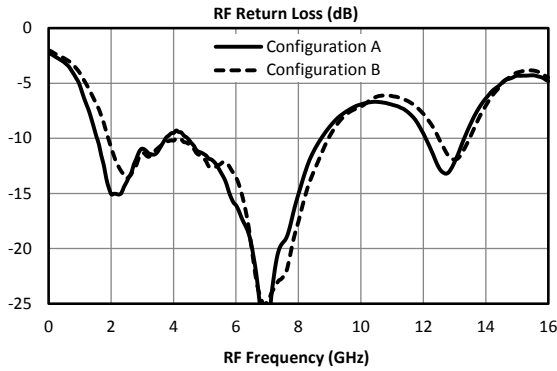

This space intentionally left blank

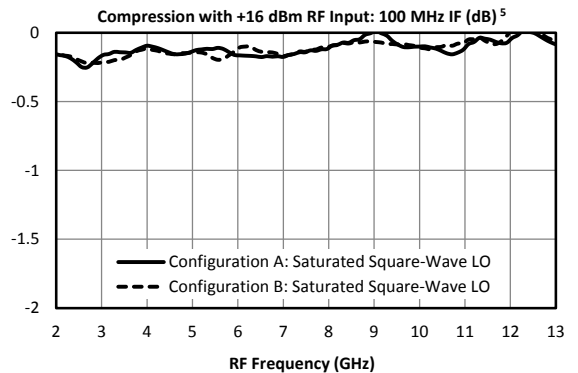
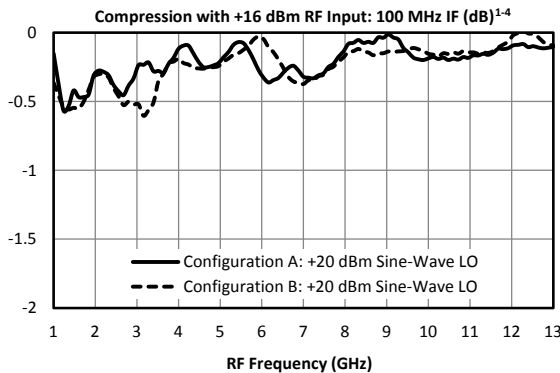

Typical Performance

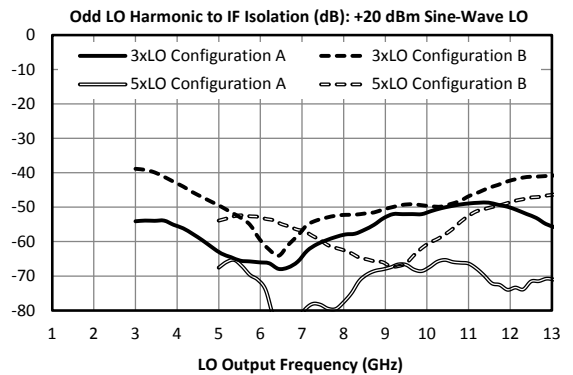
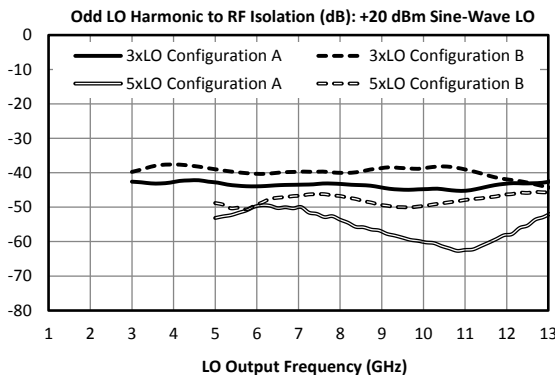
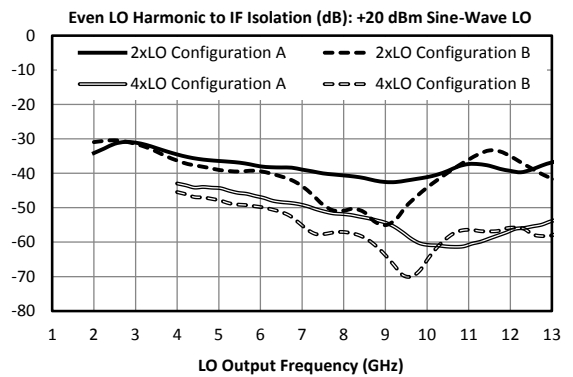
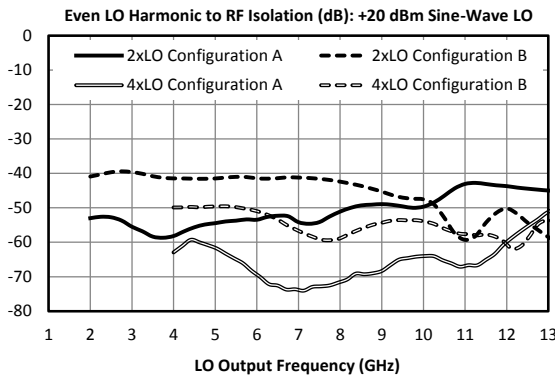
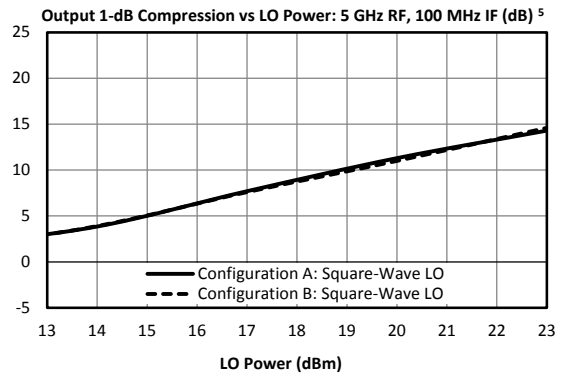
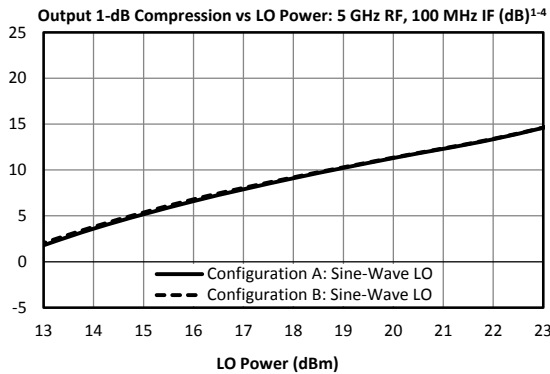
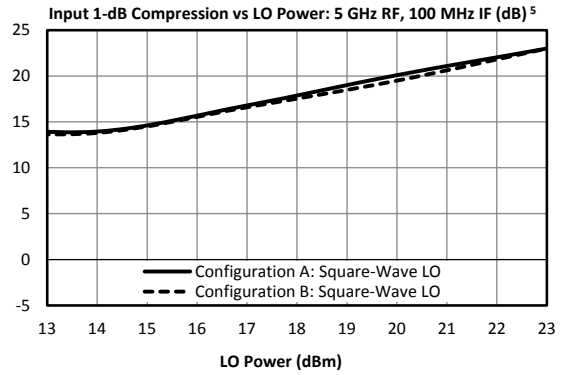
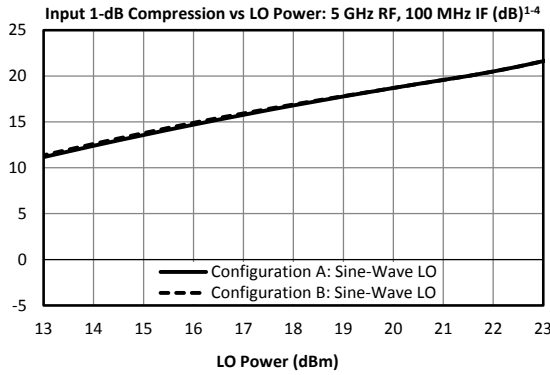

GaAs MMIC High Dynamic Range Mixer

MT3-0113HCQG

Page 6

Typical Performance

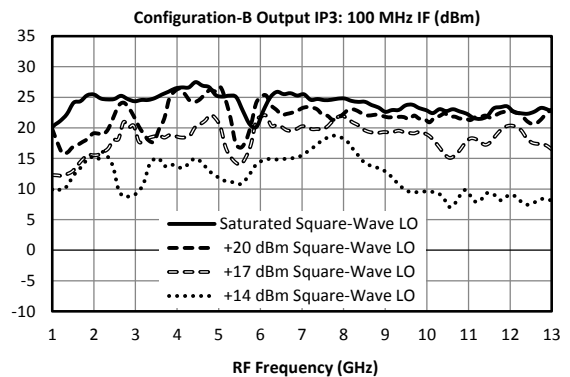
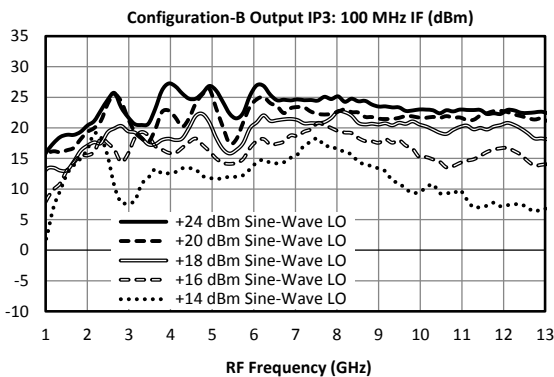
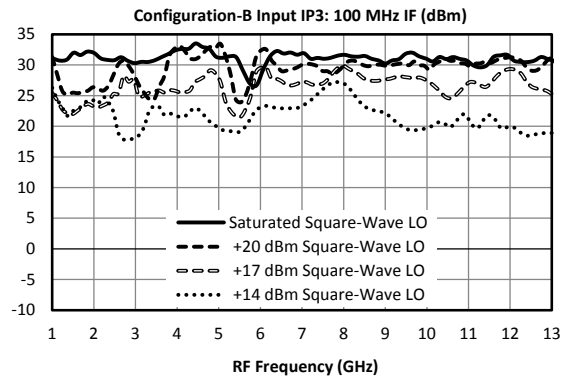
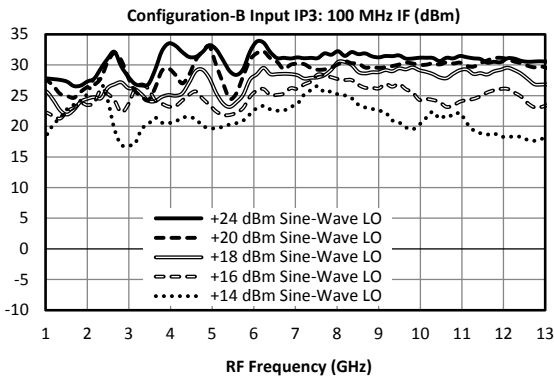
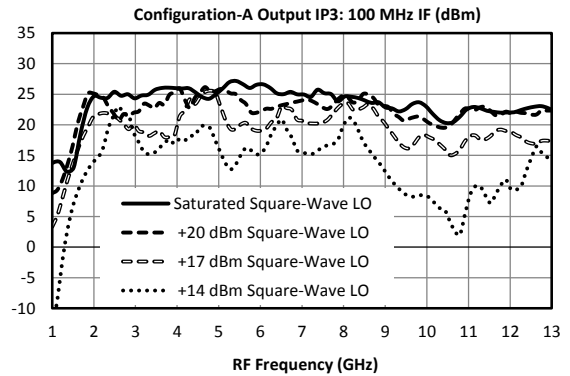
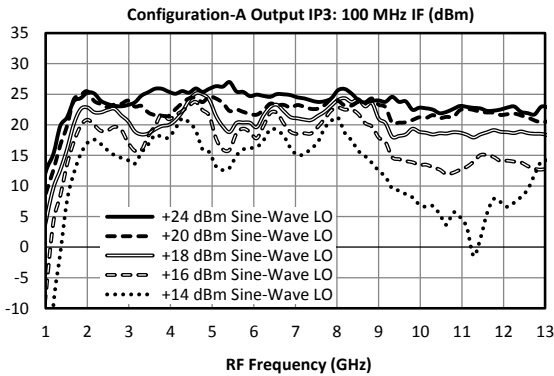
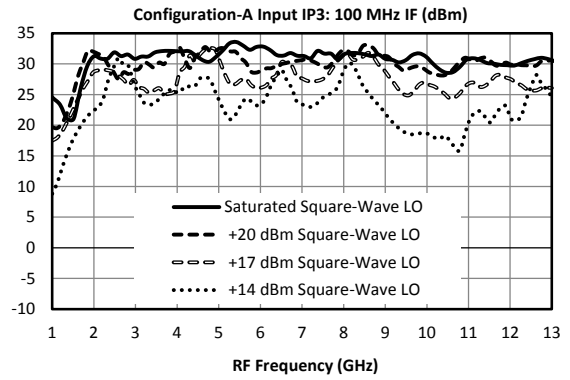
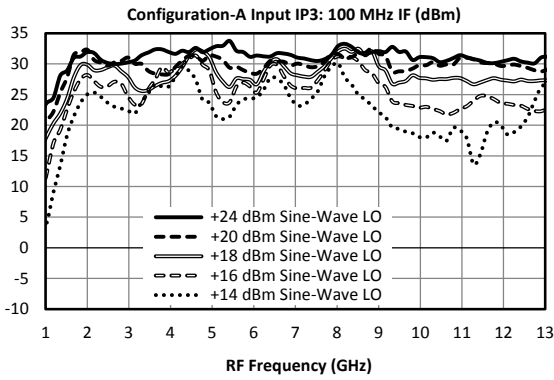

Typical Performance

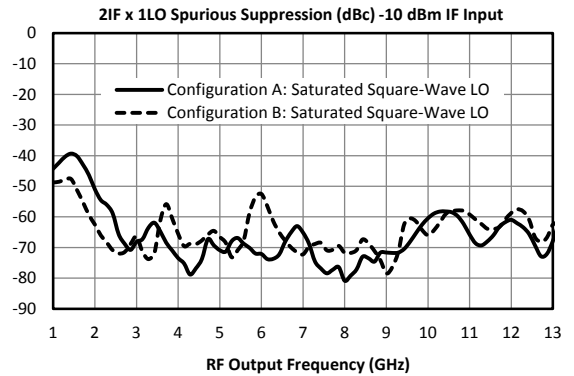
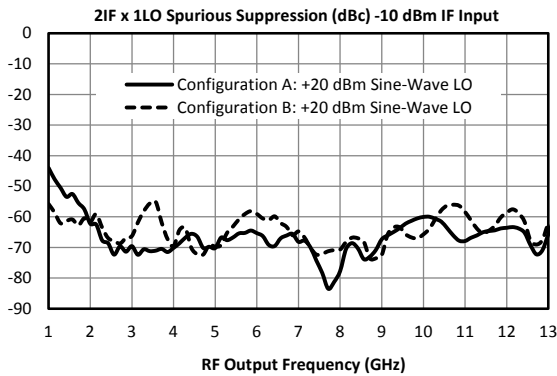
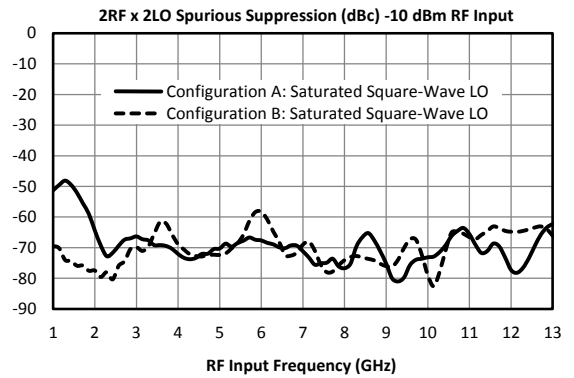
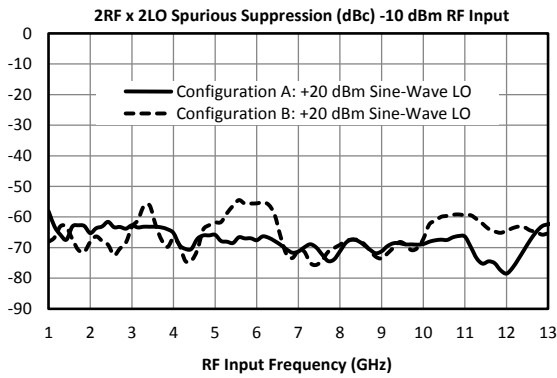



GaAs MMIC High Dynamic Range Mixer

MT3-0113HCQG

Page 8

Downconversion Spurious Suppression

Spurious data is taken by selecting RF and LO frequencies ($\pm mLO \pm nRF$) within the RF/LO bands, to create a spurious output within the IF band. The mixer is swept across the full spurious band and the mean is calculated. The numbers shown in the table below are for a -10 dBm RF input. Spurious suppression is scaled for different RF power levels by $(n-1)$, where “n” is the RF spur order. For example, the $2RF \times 2LO$ spur is 68 dBc for the A configuration for a -10 dBm input with a sine-wave LO, so a -20 dBm RF input creates a spur that is $(2-1) \times (-10 \text{ dB})$ dB lower, or 78 dBc.

Typical Downconversion Spurious Suppression (dBc): A Configuration (B Configuration), Sine Wave LO ⁶

-10 dBm RF Input	0xLO	1xLO	2xLO	3xLO	4xLO	5xLO
1xRF	30 (37)	Reference	42 (41)	19 (18)	42 (46)	25 (33)
2xRF	61 (66)	70 (69)	68 (66)	74 (67)	67 (62)	72 (64)
3xRF	112 (113)	89 (88)	99 (102)	88 (87)	100 (100)	81 (82)
4xRF	122 (131)	125 (128)	122 (122)	127 (126)	127 (123)	131 (126)
5xRF	158 (164)	145 (149)	149 (149)	142 (144)	151 (151)	146 (144)

Typical Downconversion Spurious Suppression (dBc): A Configuration (B Configuration), Square Wave LO ⁶

-10 dBm RF Input	0xLO	1xLO	2xLO	3xLO	4xLO	5xLO
1xRF	32 (39)	Reference	30 (29)	12 (11)	27 (27)	19 (18)
2xRF	62 (68)	72 (69)	70 (70)	71 (76)	65 (64)	74 (73)
3xRF	113 (113)	90 (89)	103 (105)	92 (92)	100 (107)	93 (95)
4xRF	132 (132)	130 (134)	129 (127)	135 (135)	130 (133)	132 (136)
5xRF	172 (174)	148 (152)	151 (151)	150 (151)	152 (153)	150 (155)



GaAs MMIC High Dynamic Range Mixer

MT3-0113HCQG

Page 9

Upconversion Spurious Suppression

Spurious data is taken by mixing an input within the IF band, with LO frequencies ($\pm mLO \pm nIF$), to create a spurious output within the RF output band. The mixer is swept across the full spurious output band and the mean is calculated. The numbers shown in the table below are for a -10 dBm IF input. Spurious suppression is scaled for different IF input power levels by $(n-1)$, where “n” is the IF spur order. For example, the 2IFx1LO spur is typically 67 dBc for the A configuration for a -10 dBm input with a sine-wave LO, so a -20 dBm IF input creates a spur that is $(2-1) \times (-10)$ dB lower, or 77 dBc.

Typical Upconversion Spurious Suppression (dBc): A Configuration (B Configuration), Sine Wave LO ⁶

-10 dBm IF Input	0xLO	1xLO	2xLO	3xLO	4xLO	5xLO
1xIF	27 (39)	Reference	38 (40)	17 (16)	37 (43)	26 (22)
2xIF	72 (68)	67 (64)	63 (59)	66 (58)	69 (58)	67 (59)
3xIF	112 (112)	80 (78)	91 (93)	76 (72)	87 (93)	74 (71)
4xIF	124 (130)	122 (118)	119 (113)	118 (110)	123 (106)	114 (108)
5xIF	153 (154)	139 (139)	141 (144)	128 (127)	137 (134)	117 (114)

Typical Upconversion Spurious Suppression (dBc): A Configuration (B Configuration), Square Wave LO ⁶

-10 dBm IF Input	0xLO	1xLO	2xLO	3xLO	4xLO	5xLO
1xIF	28 (38)	Reference	30 (32)	12 (11)	26 (27)	21 (17)
2xIF	81 (69)	67 (65)	64 (63)	62 (65)	61 (63)	53 (62)
3xIF	113 (112)	83 (83)	94 (95)	79 (80)	89 (90)	77 (78)
4xIF	133 (137)	128 (125)	120 (120)	117 (122)	114 (118)	104 (119)
5xIF	154 (154)	148 (149)	144 (146)	138 (141)	137 (141)	125 (129)

GaAs MMIC High Dynamic Range Mixer

MT3-0113HCQG

Page 10

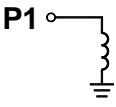
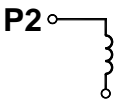
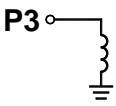
Port	Description	DC Interface Schematic
Port 1	Port 1 is DC short and AC matched to 50 Ω from 1.5 to 13 GHz. Blocking capacitor is optional.	
Port 2	Port 2 is DC open. Blocking capacitor is optional.	
Port 3	Port 3 is DC short and AC matched to 50 Ω from 1.5 to 13 GHz. Blocking capacitor is optional.	

Absolute Maximum Ratings (see note 8)	
Parameter	Maximum Rating
Port 1 DC Current	TBD mA
Port 2 DC Current	N/A
Port 3 DC Current	TBD mA
RF Power Handling (RF+LO)	+30 dBm
Operating Temperature	-40 to +100°C
Storage Temperature	-40 to +150°C

Revision History

Revision Code	Revision Date	Comment
-	October 2018	Pre-release
A	February 2019	Active - Full Production
B	May 2020	Changed cover to ceramic

DATA SHEET NOTES:

- Mixer Conversion Loss Plot IF frequency is 100 MHz unless otherwise specified.
- Mixer Noise Figure typically measures within 0.5 dB of conversion loss for IF frequencies greater than 5 MHz.
- Conversion Loss typically degrades less than 0.5 dB at +100°C and improves less than 0.5 dB at -55°C.
- Unless otherwise specified, sine-wave data is taken with +20 dBm LO drive.
- The square-wave LO is generated using an [ADM-0012-5931SM](#) pre-amplifier and an [ADM-0026-5929SM](#) output amplifier. The two amplifiers are biased with +7V, -0.25V. When specified, square-wave output power is the total of the fundamental plus harmonics. Unspecified square-wave LO (unspecified output power) is generated by saturating the amplifier chain with a +12 dBm input.
- Specifications are subject to change without notice. Contact Marki Microwave for the most recent specifications and data sheets.
- Catalog mixer circuits are continually improved. Configuration control requires custom mixer model numbers and specifications.
- Environmental specifications are currently under evaluation. Contact support for more information.

Marki Microwave reserves the right to make changes to the product(s) or information contained herein without notice. Marki Microwave makes no warranty, representation, or guarantee regarding the suitability of its products for any particular purpose, nor does Marki Microwave assume any liability whatsoever arising out of the use or application of any product.

www.markimicrowave.com

215 Vineyard Court, Morgan Hill, CA 95037 | Ph: 408.778.4200 | Fax 408.778.4300 | <mailto:info@markimicrowave.com>