

PART NUMBER	DESCRIPTION
CCT-58S	Commercial Normally Open Multi-throw, DC-26.5GHz
CT-58S	Elite Normally Open Multi-throw, DC-26.5GHz

The CCT-58S/CT-58S is an internally terminated, broadband, multi-throw, electromechanical coaxial switch designed to switch a microwave signal from a common input to any of 3, 4, 5, or 6 outputs. The characteristic impedance is 50 Ohms. Internal terminations provide an impedance match for the unselected ports. The switches are small using the popular connector spacing on a 1.062" dia. circle. Each position has an individual actuator mechanism allowing random position selection. This also minimizes switching time. The CCT-58S/CT-58S comes with a normally open actuator. For the normally open actuator, all ports are terminated in 50 Ohms, except the common input port which is open when the switch is de-energized.



ENVIRONMENTAL AND PHYSICAL CHARACTERISTICS	
Operating Temperature	
Commercial Model, CCT-58S	-40°C to 65°C
Elite Model, CT-58S	-55°C to 85°C
Vibration (MIL-STD-202 Method 214, Condition D, non-operating)	10 g's RMS
Shock (MIL-STD-202 Method 213, Condition D, non-operating)	500 g's
Standard Actuator Life	5,000,000 cycles
Actuator Life w/ Additional Features	1,000,000 cycles
Connector Type	SMA
Humidity (Moisture Seal)	Available
Weight	6 oz. (170.1g) (max.)

ELECTRICAL CHARACTERISTICS	
Form Factor	Multi-Throw,, break before make
Frequency Range	
CCT-58S	DC-26.5 GHz
CT-58S	DC-26.5 GHz
Characteristic Impedance	50 Ohms
Terminations	50Ω, 2 Watts CW max.
Operate Time	15 ms (max.)
Release Time	15 ms (max.)
Actuation Voltage Available	12 15 24 28 V
Actuation Current, max. @ ambient	420 350 250 200 mA

TYPICAL PERFORMANCE CHARACTERISTICS							
Frequency	DC-4 GHz	4-8 GHz	8-12 GHz	12-16 GHz	16-20 GHz	20-24 GHz	24-26.5 GHz
Insertion Loss, dB, typ.	0.1	0.2	0.2	0.3	0.3	0.4	0.8
Isolation, dB, typ.	80	80	80	80	75	70	70
VSWR , typ.	1.05:1	1.1:1	1.2:1	1.2:1	1.2:1	1.2:1	1.7:1

For maximum limits, please see charts on pages 7-9

PART NUMBERING SYSTEM

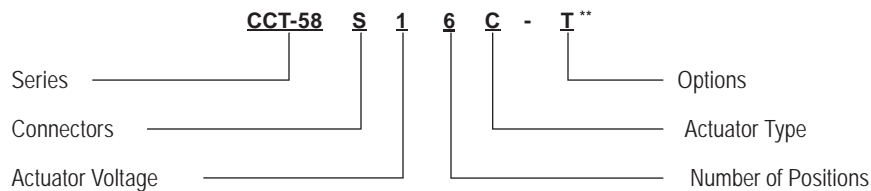

CONNECTOR	ACTUATOR VOLTAGE	NUMBER OF POSITIONS	ACTUATOR TYPE	OPTIONS
S: SMA FEMALE	1: 28 VDC NORMALLY OPEN	3: SP3T	0: NO INDICATOR CONTACTS	T: TTL DRIVERS WITH DIODES
	2: 15 VDC NORMALLY OPEN	4: SP4T	C: INDICATOR CONTACTS	D: COIL TRANSIENT SUPPRESSION DIODES
	3: 12 VDC NORMALLY OPEN	5: SP5T	D: SELF CUTOFF ONLY	R: POSITIVE + COMMON
	4: 24 VDC NORMALLY OPEN	6: SP6T		TD: DECODERS AND TTL DRIVERS WITH DIODES
				M: MOISTURE SEAL
				S: D-SUB CONNECTOR*

** SEE PARTS LIST ON PAGE 12-14

For additional options, please contact factory.

* D-Sub Connector may be 9 or 15 pin depending on number of throws. (See Connector Pinout page)

Series CCT-58S/CT-58S

Multi-Throw DC-26.5 GHz
Normally Open Coaxial Switch



SCHEMATICS AND MECHANICAL OUTLINE

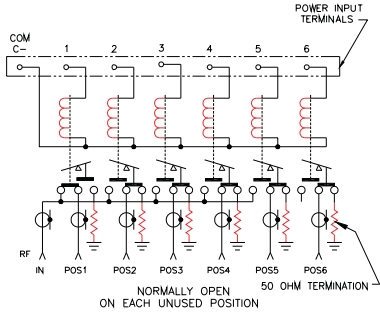

Analogue

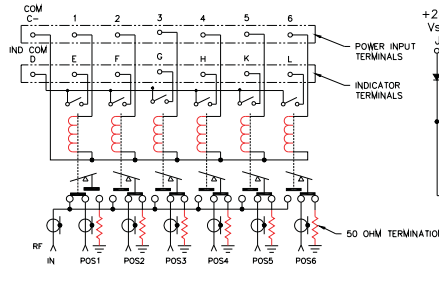

Indicators

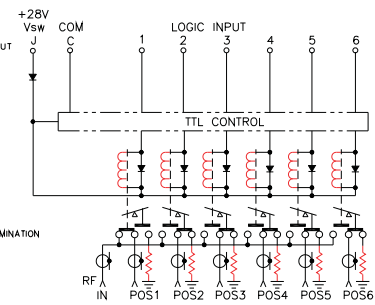

TTL

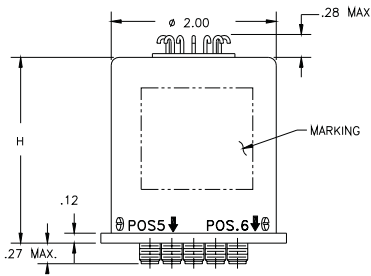
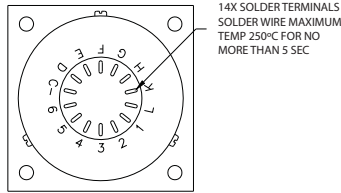

H = 1.85 STD, Indicator & D-Sub Models
H = 2.50 All OTHER Models

SP3T

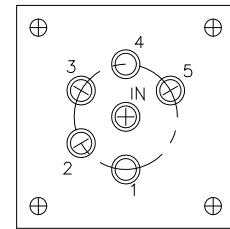
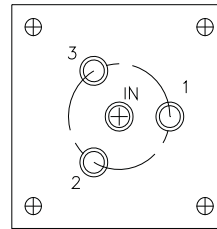

SP5T

SP6T

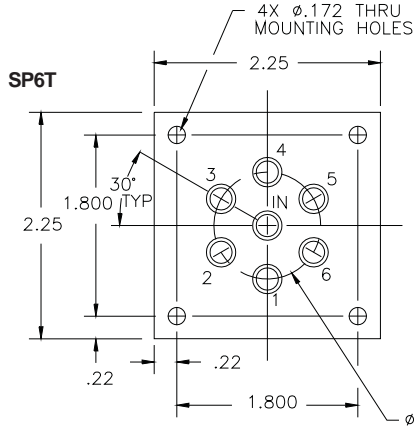

SP4T

“-S OPTION” 9-PIN D-SUB OR 15-PIN D-MICRO CONNECTOR (EXAMPLE: CCT-58S160-S)

CONNECTOR PINOUT FOR NORMALLY OPEN SP3T MULTI-THROW SWITCHES						
EXAMPLE	CT-58S130-S	CT-58S13C-S	CT-58S130-TS	CT-58S13C-TS	CT-58S130-TDS	CT-58S13C-TDS
PIN NO	2706650 9-PINS	2706650 9-PINS	2706650 9-PINS	2706650 9-PINS	2706650 9-PINS	2706650 9-PINS
INDICATOR		YES		YES		YES
TTL			YES	YES		
DECODERS & TTL					YES	YES
1	PORT 1	PORT 1	TTL 1	TTL 1	LOGIC 1	LOGIC 1
2	PORT 2	PORT 3	TTL 2	TTL 2	LOGIC 2	LOGIC 2
3	PORT 3	PORT 3	TTL 3	TTL 3		
4		E INDICATOR		E INDICATOR		E INDICATOR
5		F INDICATOR		F INDICATOR		F INDICATOR
6		G INDICATOR		G INDICATOR		G INDICATOR
7	COMMON	COMMON	COMMON	COMMON	COMMON	COMMON
8			V _{sw}	V _{sw}	V _{sw}	V _{sw}
9		D INDICATOR (COM)		D INDICATOR (COM)		D INDICATOR (COM)

CONNECTOR PINOUT FOR NORMALLY OPEN SP4T MULTI-THROW SWITCHES						
EXAMPLE	CT-58S140-S	CT-58S14C-S	CT-58S140-TS	CT-58S14C-TS	CT-58S140-TDS	CT-58S14C-TDS
PIN NO	2706650 9-PINS	C00-166-4 (CCR) 2707572 (CCT)	2706650 9-PINS	C00-166-4 (CCR) 2707572 (CCT)	2706650 9-PINS	C00-166-4 (CCR) 2707572 (CCT)
INDICATOR		YES		YES		YES
TTL			YES	YES		
DECODERS & TTL					YES	YES
1	PORT 1	PORT 1	TTL 1	TTL 1	LOGIC 1	LOGIC 1
2	PORT 2	PORT 3	TTL 2	TTL 2	LOGIC 2	LOGIC 2
3	PORT 3	PORT 3	TTL 3	TTL 3	LOGIC 3	LOGIC 3
4	PORT 4	PORT 4	TTL 4	TTL 4		
5						
6						
7	COMMON	COMMON	COMMON	COMMON	COMMON	COMMON
8			V _{sw}	V _{sw}	V _{sw}	V _{sw}
9		D INDICATOR (COM)		D INDICATOR (COM)		D INDICATOR (COM)
10		E INDICATOR		E INDICATOR		E INDICATOR
11		F INDICATOR		F INDICATOR		F INDICATOR
12		G INDICATOR		G INDICATOR		G INDICATOR
13		H INDICATOR		H INDICATOR		H INDICATOR
14						
15						

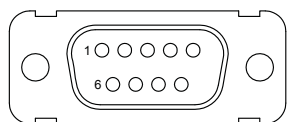

9-PIN D-SUB CONNECTOR

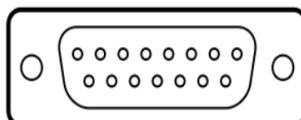

15-PIN D-SUB CONNECTOR

Series CCT-58S/CT-58S
Multi-Throw DC-26.5 GHz
Normally Open Coaxial Switch



CONNECTOR PINOUT FOR NORMALLY OPEN SP5T MULTI-THROW SWITCHES						
EXAMPLE	CT-58S150-S	CT-58S15C-S	CT-58S150-TS	CT-58S15C-TS	CT-58S150-TDS	CT-58S15C-TDS
PIN NO	2706650 9-PINS	C00-166-4 (CCR) 2707572 (CCT)	2706650 9-PINS	C00-166-4 (CCR) 2707572 (CCT)	2706650 9-PINS	C00-166-4 (CCR) 2707572 (CCT)
INDICATOR		YES		YES		YES
TTL			YES	YES		
DECODERS & TTL					YES	YES
1	PORT 1	PORT 1	TTL 1	TTL 1	LOGIC 1	LOGIC 1
2	PORT 2	PORT 3	TTL 2	TTL 2	LOGIC 2	LOGIC 2
3	PORT 3	PORT 3	TTL 3	TTL 3	LOGIC 3	LOGIC 3
4	PORT 4	PORT 4	TTL 4	TTL 4		
5	PORT 5	PORT 5	TTL 5	TTL 5		
6						
7	COMMON	COMMON	COMMON	COMMON	COMMON	COMMON
8			Vsw	Vsw	Vsw	Vsw
9		D INDICATOR (COM)		D INDICATOR (COM)		D INDICATOR (COM)
10		E INDICATOR		E INDICATOR		E INDICATOR
11		F INDICATOR		F INDICATOR		F INDICATOR
12		G INDICATOR		G INDICATOR		G INDICATOR
13		H INDICATOR		H INDICATOR		H INDICATOR
14		K INDICATOR		K INDICATOR		K INDICATOR
15						

CONNECTOR PINOUT FOR NORMALLY OPEN SP6T MULTI-THROW SWITCHES						
EXAMPLE	CT-58S160-S	CT-58S16C-S	CT-58S160-TS	CT-58S16C-TS	CT-58S160-TDS	CT-58S16C-TDS
PIN NO	2706650 9-PINS	C00-166-4 (CCR) 2707572 (CCT)	2706650 9-PINS	C00-166-4 (CCR) 2707572 (CCT)	2706650 9-PINS	C00-166-4 (CCR) 2707572 (CCT)
INDICATOR		YES		YES		YES
TTL			YES	YES		
DECODERS & TTL					YES	YES
1	PORT 1	PORT 1	TTL 1	TTL 1	LOGIC 1	LOGIC 1
2	PORT 2	PORT 3	TTL 2	TTL 2	LOGIC 2	LOGIC 2
3	PORT 3	PORT 3	TTL 3	TTL 3	LOGIC 3	LOGIC 3
4	PORT 4	PORT 4	TTL 4	TTL 4		
5	PORT 5	PORT 5	TTL 5	TTL 5		
6	PORT 6	PORT 6	TTL 6	TTL 6		
7	COMMON	COMMON	COMMON	COMMON	COMMON	COMMON
8			Vsw	Vsw	Vsw	Vsw
9		D INDICATOR (COM)		D INDICATOR (COM)		D INDICATOR (COM)
10		E INDICATOR		E INDICATOR		E INDICATOR
11		F INDICATOR		F INDICATOR		F INDICATOR
12		G INDICATOR		G INDICATOR		G INDICATOR
13		H INDICATOR		H INDICATOR		H INDICATOR
14		K INDICATOR		K INDICATOR		K INDICATOR
15		L INDICATOR		L INDICATOR		L INDICATOR

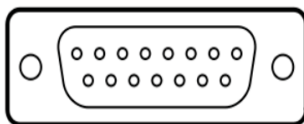

15-PIN D-SUB CONNECTOR

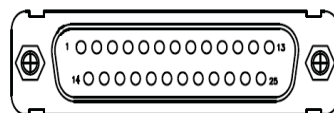

25-PIN D-SUB CONNECTOR

TRUTH TABLE Normally Open
CCT-58SX3C-T

Logic Input			RF Path			Indicator Switches		
1	2	3	J1	J2	J3	E	F	G
1	0	0	On	Off	Off	C	0	0
0	1	0	Off	On	Off	0	C	0
0	0	1	Off	Off	On	0	0	C

TRUTH TABLE Normally Open
CCT-58SX3C-TD

Logic Input		RF Path			Indicator Switches		
1	2	J1	J2	J3	E	F	G
0	0	On	Off	Off	C	0	0
1	0	Off	On	Off	0	C	0
0	1	Off	Off	On	0	0	C
1	1	Off	Off	Off	0	0	0

TRUTH TABLE Normally Open
CCT-58SX4C-T

Logic Input				RF Path				Indicator Switches			
1	2	3	4	J1	J2	J3	J4	E	F	G	H
1	0	0	0	On	Off	Off	Off	C	0	0	0
0	1	0	0	Off	On	Off	Off	0	C	0	0
0	0	1	0	Off	Off	On	Off	0	0	C	0
0	0	0	1	Off	Off	Off	On	0	0	0	C

TRUTH TABLE Normally Open
CCT-58SX4C-TD

Logic Input			RF Path				Indicator Switches			
1	2	3	J1	J2	J3	J4	E	F	G	H
0	0	0	On	Off	Off	Off	C	0	0	0
1	0	0	Off	On	Off	Off	0	C	0	0
0	1	0	Off	Off	On	Off	0	0	C	0
1	1	0	Off	Off	Off	On	0	0	0	C
1	1	1	Off	Off	Off	Off	0	0	0	0

Series CCT-58S/CT-58S

Multi-Throw DC-26.5 GHz
Normally Open Coaxial Switch



TRUTH TABLE Normally Open CCT-58SX5C-T

Logic Input					RF Path					Indicator Switches				
1	2	3	4	5	J1	J2	J3	J4	J5	E	F	G	H	K
1	0	0	0	0	On	Off	Off	Off	Off	C	0	0	0	0
0	1	0	0	0	Off	On	Off	Off	Off	0	C	0	0	0
0	0	1	0	0	Off	Off	On	Off	Off	0	0	C	0	0
0	0	0	1	0	Off	Off	Off	On	Off	0	0	0	C	0
0	0	0	0	1	Off	Off	Off	Off	On	0	0	0	0	C

TRUTH TABLE Normally Open CCT-58SX5C-TD

Logic Input			RF Path					Indicator Switches				
1	2	3	J1	J2	J3	J4	J5	E	F	G	H	K
0	0	0	On	Off	Off	Off	Off	C	0	0	0	0
1	0	0	Off	On	Off	Off	Off	0	C	0	0	0
0	1	0	Off	Off	On	Off	Off	0	0	C	0	0
1	1	0	Off	Off	Off	On	Off	0	0	0	C	0
0	0	1	Off	Off	Off	Off	On	0	0	0	0	C
1	1	1	Off	Off	Off	Off	Off	0	0	0	0	0

TRUTH TABLE Normally Open CCT-58SX6C-T

Logic Input						RF Path						Indicator Switches					
1	2	3	4	5	6	J1	J2	J3	J4	J5	J6	E	F	G	H	K	L
1	0	0	0	0	0	On	Off	Off	Off	Off	Off	C	0	0	0	0	0
0	1	0	0	0	0	Off	On	Off	Off	Off	Off	0	C	0	0	0	0
0	0	1	0	0	0	Off	Off	On	Off	Off	Off	0	0	C	0	0	0
0	0	0	1	0	0	Off	Off	Off	On	Off	Off	0	0	0	C	0	0
0	0	0	0	1	0	Off	Off	Off	Off	On	Off	0	0	0	0	C	0
0	0	0	0	0	1	Off	Off	Off	Off	Off	On	0	0	0	0	0	C

TRUTH TABLE Normally Open CCT-58SX6C-TD

Logic Input			RF Path						Indicator Switches					
1	2	3	J1	J2	J3	J4	J5	J6	E	F	G	H	K	L
0	0	0	On	Off	Off	Off	Off	Off	C	0	0	0	0	0
1	0	0	Off	On	Off	Off	Off	Off	0	C	0	0	0	0
0	1	0	Off	Off	On	Off	Off	Off	0	0	C	0	0	0
1	1	0	Off	Off	Off	On	Off	Off	0	0	0	C	0	0
0	0	1	Off	Off	Off	Off	On	Off	0	0	0	0	C	0
1	0	1	Off	Off	Off	Off	Off	On	0	0	0	0	0	C
1	1	1	Off	Off	Off	Off	Off	Off	0	0	0	0	0	0

TYPICAL NARROWBAND RF INSERTION LOSS PERFORMANCE CURVES

Insertion Loss (DC-4 GHz)

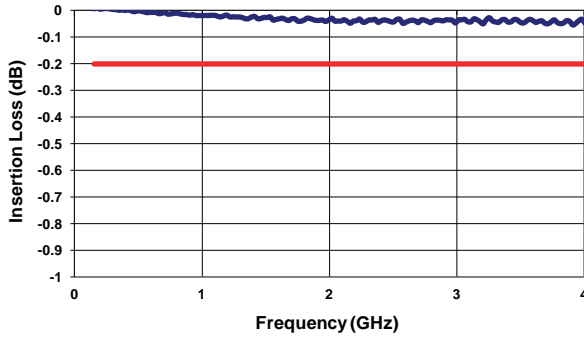

Insertion Loss (4-8 GHz)

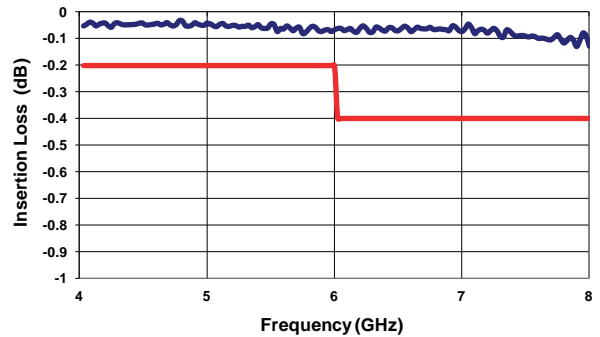

Insertion Loss (8-12 GHz)

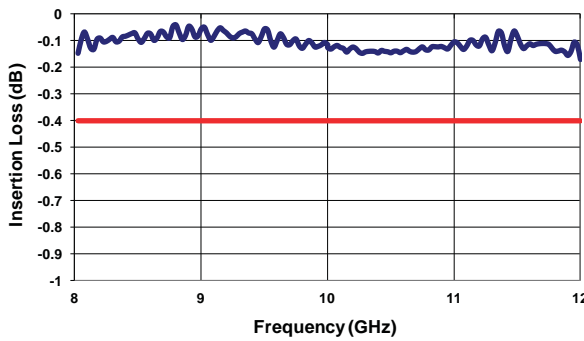

Insertion Loss (12-16 GHz)

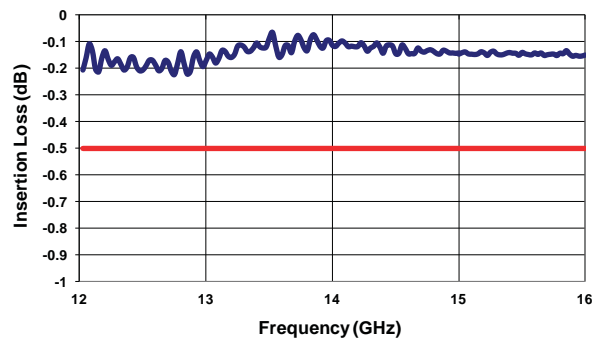

Insertion Loss (16-20 GHz)

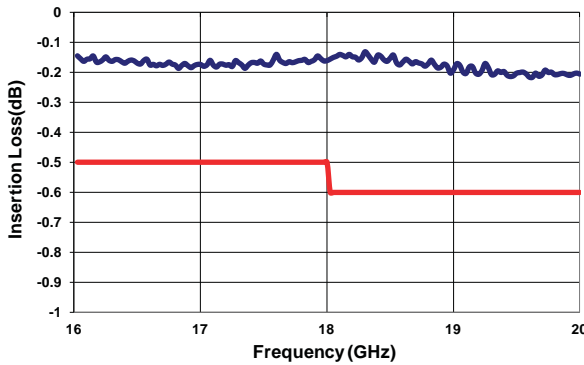

Insertion Loss (20-24 GHz)

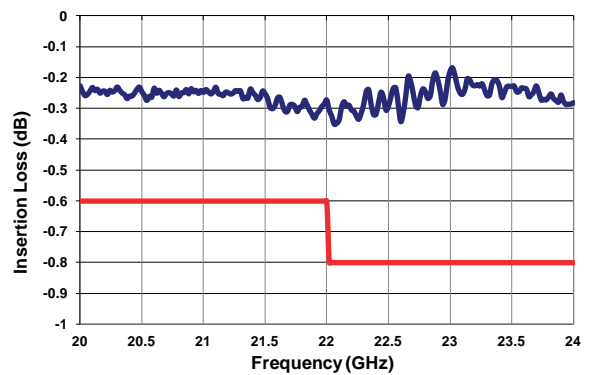

Insertion Loss (24-26.5 GHz)

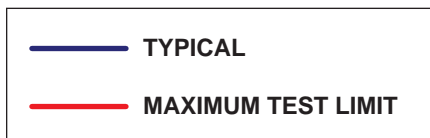
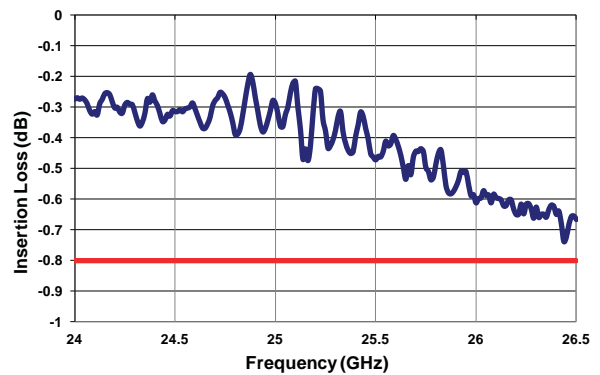

TYPICAL NARROWBAND RF ISOLATION PERFORMANCE CURVES

Isolation (DC-4 GHz)

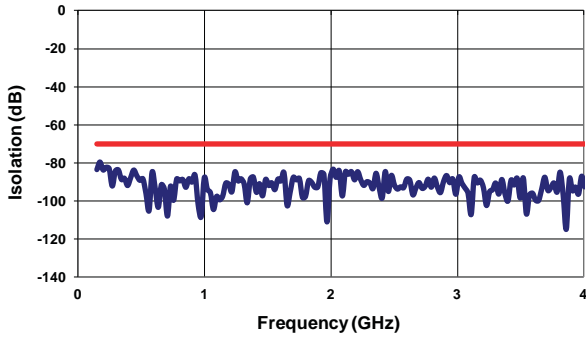

Isolation (4-8 GHz)

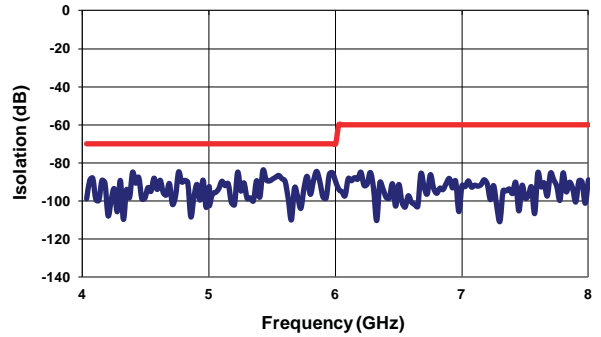

Isolation (8-12 GHz)

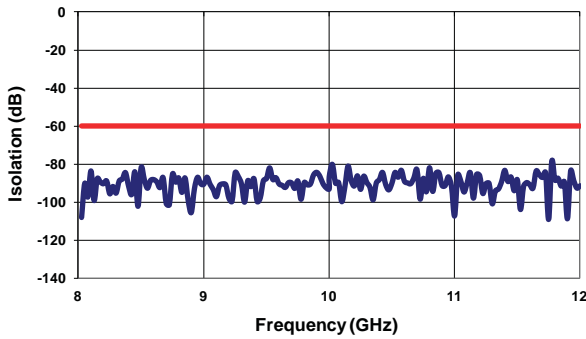

Isolation (12-16 GHz)

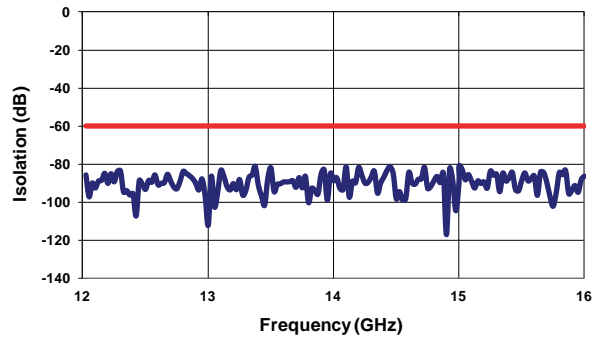

Isolation (16-20 GHz)

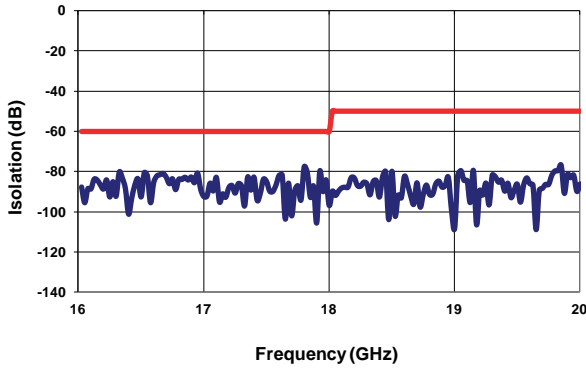

Isolation (20-24 GHz)

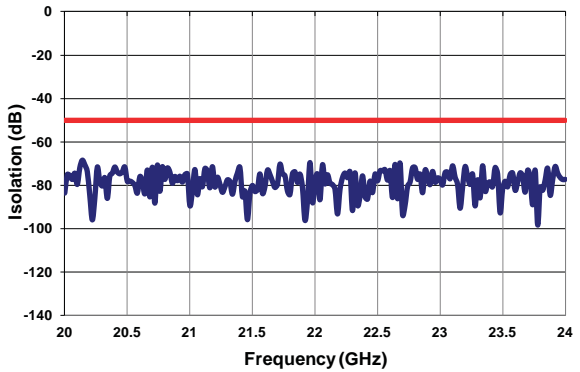

Isolation (24-26.5 GHz)

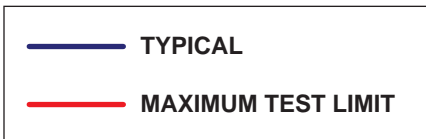
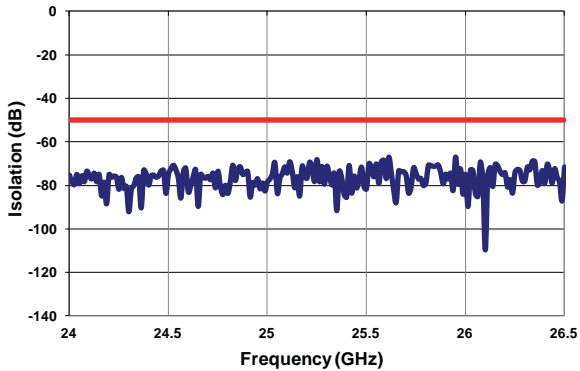

TYPICAL NARROWBAND RF VSWR PERFORMANCE CURVES

VSWR (DC-4 GHz)

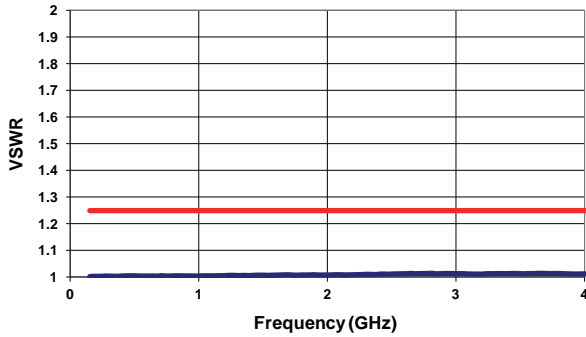

VSWR (4-8 GHz)

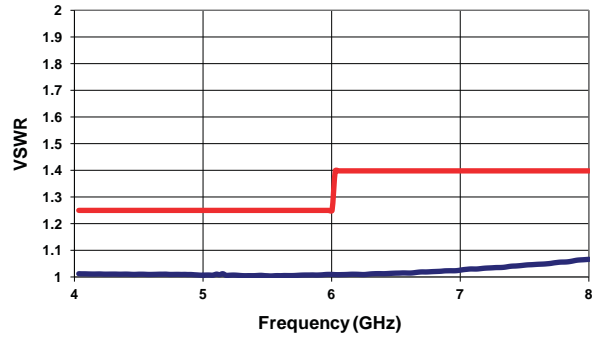

VSWR (8-12 GHz)

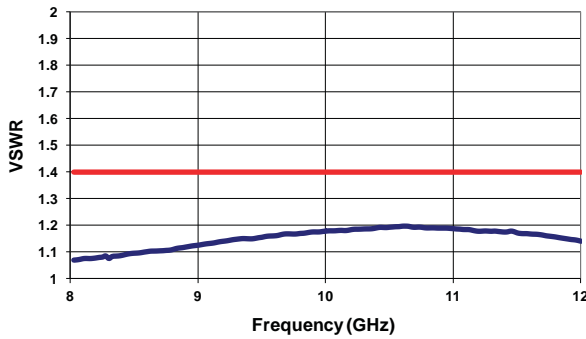

VSWR (12-16 GHz)

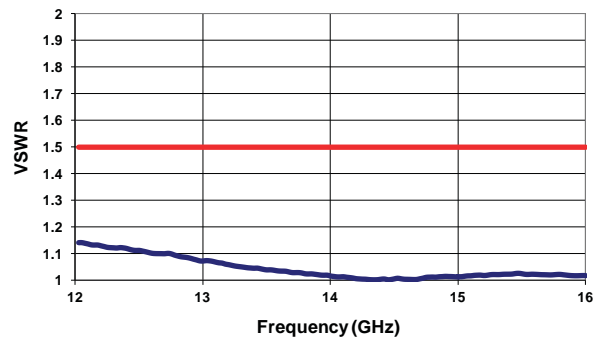

VSWR (16-20 GHz)

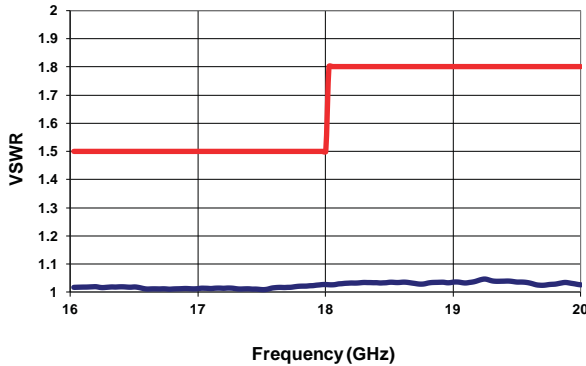

VSWR (20-22 GHz)

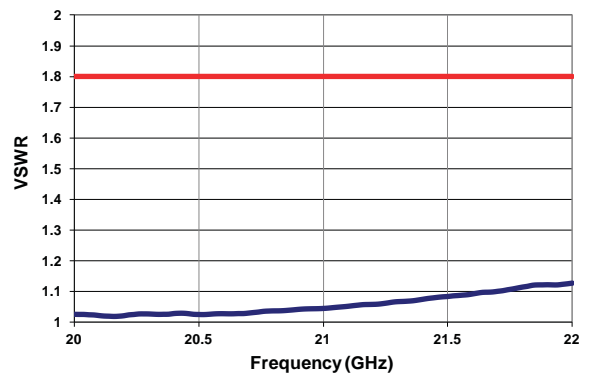

VSWR (24-26.5 GHz)

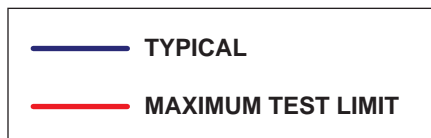
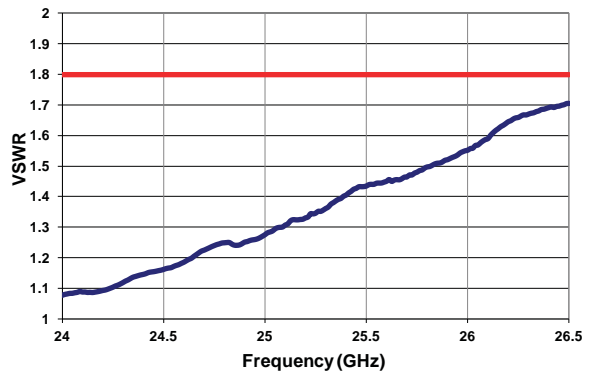

TYPICAL POWER PERFORMANCE CURVE

Power Handling vs. Frequency

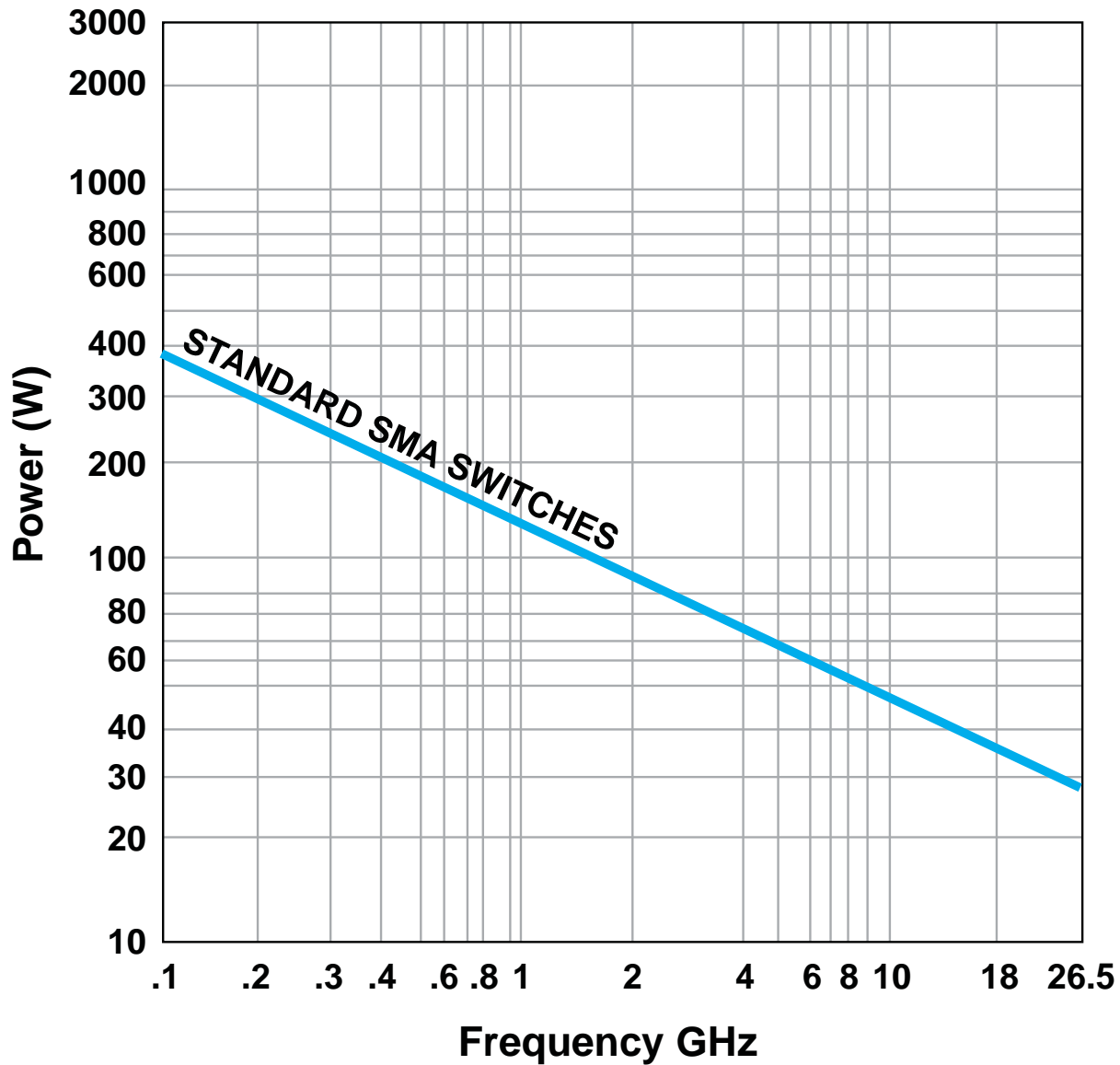

Estimates based on the following reference conditions:

- Ambient temperature of 40°C or less
- Sea level operation
- Load VSWR of 1.20:1 maximum
- No high-power (hot) switching

Please contact Teledyne Coax Switches for derating factors when applications do not meet the foregoing reference conditions.

GLOSSARY

Actuator

An actuator is the electromechanical mechanism that transfers the RF contacts from one position to another upon DC command.

Arc Suppression Diode

A diode is connected in parallel with the coil. This diode limits the “reverse EMF spike” generated when the coil de-energizes to 0.7 volts. The diode cathode is connected to the positive side of the coil and the anode is connected to the negative side.

Date Code

All switches are marked with either a unique serial number or a date code. Date codes are in accordance with MIL-STD-1285 Paragraph 5.2.5 and consist of four digits. The first two digits define the year and the last two digits define the week of the year (YYWW). Thus, 1032 identifies switches that passed through final inspection during the 32nd week of 2010.

Indicator

Indicators tell the system which position the switch is in. Other names for indicators are telemetry contacts or tellback circuit. Indicators are usually a set of internally mounted DC contacts linked to the actuator. They can be wired to digital input lines, status lights, or interlocks. Unless otherwise specified, the maximum indicator contact rating is 30 Vdc, 50 mA, or 1.5 Watts into a resistive load.

Internal Termination

Unselected ports are internally terminated to a matched load. The load is 50Ω resistive device. The max RF power rating is 2 Watts CW. Without the internal termination option, the unselected ports are open circuits.

Isolation

Isolation is the measure of the power level at the output connector of an unconnected RF channel as referenced to the power at the input connector. It is specified in dB below the input power level.

Multi-Throw Switch

A multi-throw switch is a switch with one input and three or more output ports. The CCT-58 can switch a microwave signal to any of 2,3,4,5 or 6 output from a single common input.

Switching Time

Switching time is the total interval beginning with the arrival of the leading edge of the command pulse at the switch DC input and ending with the completion of the switch transfer, including contact bounce. It consists of three parts: (1) inductive delay in the coil, (2) transfer time of the physical movement of the contacts, and (3) the bounce time of the RF contacts.

TTL Switch Driver Option

As a special option, switch drivers can be provided for both failsafe and latching switches, which are compatible with industry-standard low-power Schottky TTL circuits.

TD-Option

This option includes a decoder. The 3-bit parallel command is decoded to internally select the appropriate position. See the logic tables. The TD-Option increases the Vsw supply current demand by 50mA max at 28Vdc and +20°C.

Performance Parameters vs Frequency

Generally speaking, the RF performance of coaxial switches is frequency dependent. With increasing frequency, VSWR and insertion loss increase while isolation decreases. All data sheets specify these three parameters as “worst case” at the highest operating frequency. If the switch is to be used over a narrow frequency band, better performance can be achieved.

Actuator Current vs Temperature

The resistance of the actuator coil varies as a function of temperature. There is an inverse relationship between the operating temperature of the switch and the actuator drive current. For switches operating at 28 VDC, the approximate actuator drive current at temperature, T, can be calculated using the equation:

$$I_T = \frac{I_A}{[1 + .00385 (T-20)]}$$

Where:

I_T = Actuator current at temperature, T

I_A = Room temperature actuator current – see data sheet

T = Temperature of interest in °C

Magnetic Sensitivity

An electro-mechanical switch can be sensitive to ferrous materials and external magnetic fields. Neighboring ferrous materials should be permitted no closer than 0.5 inches and adjacent external magnetic fields should be limited to a flux density of less than 5 Gauss.

SPECIAL FEATURE

Switching High-Power or Highly Sensitive Signals

Ensure the most linear response with the best galvanically matched contact system in the industry. Extremely low passive intermodulation is standard on all of our switches.

Carrier Frequency 1	Carrier Frequency 2	PIM 3rd Order Frequency	PIM 5th Order Frequency
870 MHz	893 MHz	847 MHz	824 MHz

	3rd Order Intermodulation	5th Order Intermodulation
Multiple Positions	-96 dBm	-115 dBm
	-139 dBc	-158 dBc

Series CCT-58S/CT-58S

Multi-Throw DC-26.5 GHz
Normally Open Coaxial Switch



NORMALLY OPEN CCT-58S/CT-58S PART NUMBER LIST

	PART No.		PART No.		PART No.		PART No.
1	CCT-58SX3C	43	CCT-58SX30-TMS	85	CCT-58SX40-TDS	127	CCT-58SX50-TDM
2	CCT-58SX3C-D	44	CCT-58SX30-TS	86	CCT-58SX40-TM	128	CCT-58SX50-TDMS
3	CCT-58SX3C-DM	45	CCT-58SX4C	87	CCT-58SX40-TMS	129	CCT-58SX50-TDS
4	CCT-58SX3C-DR	46	CCT-58SX4C-D	88	CCT-58SX40-TS	130	CCT-58SX50-TM
5	CCT-58SX3C-DRM	47	CCT-58SX4C-DM	89	CCT-58SX5C	131	CCT-58SX50-TMS
6	CCT-58SX3C-DRS	48	CCT-58SX4C-DR	90	CCT-58SX5C-D	132	CCT-58SX50-TS
7	CCT-58SX3C-DS	49	CCT-58SX4C-DRM	91	CCT-58SX5C-DM	133	CCT-58SX6C
8	CCT-58SX3C-M	50	CCT-58SX4C-DRS	92	CCT-58SX5C-DR	134	CCT-58SX6C-D
9	CCT-58SX3C-MS	51	CCT-58SX4C-DS	93	CCT-58SX5C-DRM	135	CCT-58SX6C-DM
10	CCT-58SX3C-R	52	CCT-58SX4C-M	94	CCT-58SX5C-DRS	136	CCT-58SX6C-DR
11	CCT-58SX3C-RM	53	CCT-58SX4C-MS	95	CCT-58SX5C-DS	137	CCT-58SX6C-DRM
12	CCT-58SX3C-RMS	54	CCT-58SX4C-R	96	CCT-58SX5C-M	138	CCT-58SX6C-DRS
13	CCT-58SX3C-RS	55	CCT-58SX4C-RM	97	CCT-58SX5C-MS	139	CCT-58SX6C-DS
14	CCT-58SX3C-S	56	CCT-58SX4C-RMS	98	CCT-58SX5C-R	140	CCT-58SX6C-M
15	CCT-58SX3C-T	57	CCT-58SX4C-RS	99	CCT-58SX5C-RM	141	CCT-58SX6C-MS
16	CCT-58SX3C-TD	58	CCT-58SX4C-S	100	CCT-58SX5C-RMS	142	CCT-58SX6C-R
17	CCT-58SX3C-TDM	59	CCT-58SX4C-T	101	CCT-58SX5C-RS	143	CCT-58SX6C-RM
18	CCT-58SX3C-TDMS	60	CCT-58SX4C-TD	102	CCT-58SX5C-S	144	CCT-58SX6C-RMS
19	CCT-58SX3C-TDS	61	CCT-58SX4C-TDM	103	CCT-58SX5C-T	145	CCT-58SX6C-RS
20	CCT-58SX3C-TM	62	CCT-58SX4C-TDMS	104	CCT-58SX5C-TD	146	CCT-58SX6C-S
21	CCT-58SX3C-TMS	63	CCT-58SX4C-TDS	105	CCT-58SX5C-TDM	147	CCT-58SX6C-T
22	CCT-58SX3C-TS	64	CCT-58SX4C-TM	106	CCT-58SX5C-TDMS	148	CCT-58SX6C-TD
23	CCT-58SX30	65	CCT-58SX4C-TMS	107	CCT-58SX5C-TDS	149	CCT-58SX6C-TDM
24	CCT-58SX30-D	66	CCT-58SX4C-TS	108	CCT-58SX5C-TM	150	CCT-58SX6C-TDMS
25	CCT-58SX30-DM	67	CCT-58SX40	109	CCT-58SX5C-TMS	151	CCT-58SX6C-TDS
26	CCT-58SX30-DR	68	CCT-58SX40-D	110	CCT-58SX5C-TS	152	CCT-58SX6C-TM
27	CCT-58SX30-DRM	69	CCT-58SX40-DM	111	CCT-58SX50	153	CCT-58SX6C-TMS
28	CCT-58SX30-DRS	70	CCT-58SX40-DR	112	CCT-58SX50-D	154	CCT-58SX6C-TS
29	CCT-58SX30-DS	71	CCT-58SX40-DRM	113	CCT-58SX50-DM	155	CCT-58SX60
30	CCT-58SX30-M	72	CCT-58SX40-DRS	114	CCT-58SX50-DR	156	CCT-58SX60-D
31	CCT-58SX30-MS	73	CCT-58SX40-DS	115	CCT-58SX50-DRM	157	CCT-58SX60-DM
32	CCT-58SX30-R	74	CCT-58SX40-M	116	CCT-58SX50-DRS	158	CCT-58SX60-DR
33	CCT-58SX30-RM	75	CCT-58SX40-MS	117	CCT-58SX50-DS	159	CCT-58SX60-DRM
34	CCT-58SX30-RMS	76	CCT-58SX40-R	118	CCT-58SX50-M	160	CCT-58SX60-DRS
35	CCT-58SX30-RS	77	CCT-58SX40-RM	119	CCT-58SX50-MS	161	CCT-58SX60-DS
36	CCT-58SX30-S	78	CCT-58SX40-RMS	120	CCT-58SX50-R	162	CCT-58SX60-M
37	CCT-58SX30-T	79	CCT-58SX40-RS	121	CCT-58SX50-RM	163	CCT-58SX60-MS
38	CCT-58SX30-TD	80	CCT-58SX40-S	122	CCT-58SX50-RMS	164	CCT-58SX60-R
39	CCT-58SX30-TDM	81	CCT-58SX40-T	123	CCT-58SX50-RS	165	CCT-58SX60-RM
40	CCT-58SX30-TDMS	82	CCT-58SX40-TD	124	CCT-58SX50-S	166	CCT-58SX60-RMS
41	CCT-58SX30-TDS	83	CCT-58SX40-TDM	125	CCT-58SX50-T	167	CCT-58SX60-RS
42	CCT-58SX30-TM	84	CCT-58SX40-TDMS	126	CCT-58SX50-TD	168	CCT-58SX60-S

* X = 1 (28Vdc), 2 (15Vdc), 3 (12Vdc) and 4 (24Vdc)

NORMALLY OPEN CCT-58S/CT-58S PART NUMBER LIST

	PART No.		PART No.		PART No.		PART No.
169	CCT-58SX60-T	211	CT-58SX30-RS	253	CT-58SX40-RM	295	CT-58SX50-MS
170	CCT-58SX60-TD	212	CT-58SX30-S	254	CT-58SX40-RMS	296	CT-58SX50-R
171	CCT-58SX60-TDM	213	CT-58SX30-T	255	CT-58SX40-RS	297	CT-58SX50-RM
172	CCT-58SX60-TDMS	214	CT-58SX30-TD	256	CT-58SX40-S	298	CT-58SX50-RMS
173	CCT-58SX60-TDS	215	CT-58SX30-TDM	257	CT-58SX40-T	299	CT-58SX50-RS
174	CCT-58SX60-TM	216	CT-58SX30-TDMS	258	CT-58SX40-TD	300	CT-58SX50-S
175	CCT-58SX60-TMS	217	CT-58SX30-TDS	259	CT-58SX40-TDM	301	CT-58SX50-T
176	CCT-58SX60-TS	218	CT-58SX30-TM	260	CT-58SX40-TDMS	302	CT-58SX50-TD
177	CT-58SX3C	219	CT-58SX30-TMS	261	CT-58SX40-TDS	303	CT-58SX50-TDM
178	CT-58SX3C-D	220	CT-58SX30-TS	262	CT-58SX40-TM	304	CT-58SX50-TDMS
179	CT-58SX3C-DM	221	CT-58SX4C	263	CT-58SX40-TMS	305	CT-58SX50-TDS
180	CT-58SX3C-DR	222	CT-58SX4C-D	264	CT-58SX40-TS	306	CT-58SX50-TM
181	CT-58SX3C-DRM	223	CT-58SX4C-DM	265	CT-58SX5C	307	CT-58SX50-TMS
182	CT-58SX3C-DRS	224	CT-58SX4C-DR	266	CT-58SX5C-D	308	CT-58SX50-TS
183	CT-58SX3C-DS	225	CT-58SX4C-DRM	267	CT-58SX5C-DM	309	CT-58SX6C
184	CT-58SX3C-M	226	CT-58SX4C-DRS	268	CT-58SX5C-DR	310	CT-58SX6C-D
185	CT-58SX3C-MS	227	CT-58SX4C-DS	269	CT-58SX5C-DRM	311	CT-58SX6C-DM
186	CT-58SX3C-R	228	CT-58SX4C-M	270	CT-58SX5C-DRS	312	CT-58SX6C-DR
187	CT-58SX3C-RM	229	CT-58SX4C-MS	271	CT-58SX5C-DS	313	CT-58SX6C-DRM
188	CT-58SX3C-RMS	230	CT-58SX4C-R	272	CT-58SX5C-M	314	CT-58SX6C-DRS
189	CT-58SX3C-RS	231	CT-58SX4C-RM	273	CT-58SX5C-MS	315	CT-58SX6C-DS
190	CT-58SX3C-S	232	CT-58SX4C-RMS	274	CT-58SX5C-R	316	CT-58SX6C-M
191	CT-58SX3C-T	233	CT-58SX4C-RS	275	CT-58SX5C-RM	317	CT-58SX6C-MS
192	CT-58SX3C-TD	234	CT-58SX4C-S	276	CT-58SX5C-RMS	318	CT-58SX6C-R
193	CT-58SX3C-TDM	235	CT-58SX4C-T	277	CT-58SX5C-RS	319	CT-58SX6C-RM
194	CT-58SX3C-TDMS	236	CT-58SX4C-TD	278	CT-58SX5C-S	320	CT-58SX6C-RMS
195	CT-58SX3C-TDS	237	CT-58SX4C-TDM	279	CT-58SX5C-T	321	CT-58SX6C-RS
196	CT-58SX3C-TM	238	CT-58SX4C-TDMS	280	CT-58SX5C-TD	322	CT-58SX6C-S
197	CT-58SX3C-TMS	239	CT-58SX4C-TDS	281	CT-58SX5C-TDM	323	CT-58SX6C-T
198	CT-58SX3C-TS	240	CT-58SX4C-TM	282	CT-58SX5C-TDMS	324	CT-58SX6C-TD
199	CT-58SX30	241	CT-58SX4C-TMS	283	CT-58SX5C-TDS	325	CT-58SX6C-TDM
200	CT-58SX30-D	242	CT-58SX4C-TS	284	CT-58SX5C-TM	326	CT-58SX6C-TDMS
201	CT-58SX30-DM	243	CT-58SX40	285	CT-58SX5C-TMS	327	CT-58SX6C-TDS
202	CT-58SX30-DR	244	CT-58SX40-D	286	CT-58SX5C-TS	328	CT-58SX6C-TM
203	CT-58SX30-DRM	245	CT-58SX40-DM	287	CT-58SX50	329	CT-58SX6C-TMS
204	CT-58SX30-DRS	246	CT-58SX40-DR	288	CT-58SX50-D	330	CT-58SX6C-TS
205	CT-58SX30-DS	247	CT-58SX40-DRM	289	CT-58SX50-DM	331	CT-58SX60
206	CT-58SX30-M	248	CT-58SX40-DRS	290	CT-58SX50-DR	332	CT-58SX60-D
207	CT-58SX30-MS	249	CT-58SX40-DS	291	CT-58SX50-DRM	333	CT-58SX60-DM
208	CT-58SX30-R	250	CT-58SX40-M	292	CT-58SX50-DRS	334	CT-58SX60-DR
209	CT-58SX30-RM	251	CT-58SX40-MS	293	CT-58SX50-DS	335	CT-58SX60-DRM
210	CT-58SX30-RMS	252	CT-58SX40-R	294	CT-58SX50-M	336	CT-58SX60-DRS

* X = 1 (28Vdc), 2 (15Vdc), 3 (12Vdc) and 4 (24Vdc)

Series CCT-58S/CT-58S

Multi-Throw DC-26.5 GHz

Normally Open Coaxial Switch



NORMALLY OPEN CCT-58S/CT-58S PART NUMBER LIST

	PART No.
337	CT-58SX60-DS
338	CT-58SX60-M
339	CT-58SX60-MS
340	CT-58SX60-R
341	CT-58SX60-RM
342	CT-58SX60-RMS
343	CT-58SX60-RS
344	CT-58SX60-S
345	CT-58SX60-T
346	CT-58SX60-TD
347	CT-58SX60-TDM
348	CT-58SX60-TDMS
349	CT-58SX60-TDS
350	CT-58SX60-TM
351	CT-58SX60-TMS
352	CT-58SX60-TS

* X = 1 (28Vdc), 2 (15Vdc), 3 (12Vdc) and 4 (24Vdc)

Данный компонент на территории Российской Федерации

Вы можете приобрести в компании MosChip.

Для оперативного оформления запроса Вам необходимо перейти по данной ссылке:

<http://moschip.ru/get-element>

Вы можете разместить у нас заказ для любого Вашего проекта, будь то серийное производство или разработка единичного прибора.

В нашем ассортименте представлены ведущие мировые производители активных и пассивных электронных компонентов.

Нашей специализацией является поставка электронной компонентной базы двойного назначения, продукции таких производителей как XILINX, Intel (ex.ALTERA), Vicor, Microchip, Texas Instruments, Analog Devices, Mini-Circuits, Amphenol, Glenair.

Сотрудничество с глобальными дистрибьюторами электронных компонентов, предоставляет возможность заказывать и получать с международных складов практически любой перечень компонентов в оптимальные для Вас сроки.

На всех этапах разработки и производства наши партнеры могут получить квалифицированную поддержку опытных инженеров.

Система менеджмента качества компании отвечает требованиям в соответствии с ГОСТ Р ИСО 9001, ГОСТ РВ 0015-002 и ЭС РД 009

Офис по работе с юридическими лицами:

105318, г.Москва, ул.Щербаковская д.3, офис 1107, 1118, ДЦ «Щербаковский»

Телефон: +7 495 668-12-70 (многоканальный)

Факс: +7 495 668-12-70 (доб.304)

E-mail: info@moschip.ru

Skype отдела продаж:

moschip.ru

moschip.ru_4

moschip.ru_6

moschip.ru_9