

Drawing(mm)

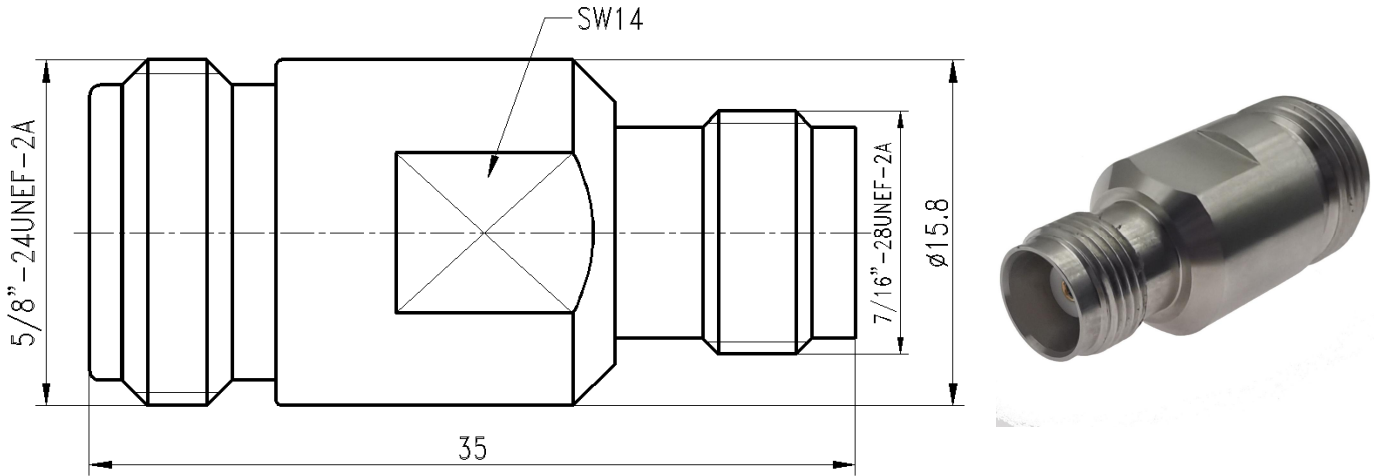

Electrical & Environmental

Impedance	50 ohm
Frequency Range	DC-18 GHz
VSWR	1.2 max
Operating Temp	-55°C to +165°C
Interface	N&TNCA per MIL-STD-348

Material

Connector Body	Passivated stainless steel
Center Contact	Gold plated beryllium copper
Insulator	PEI&PTFE

Typical Test Data

