

### Product Overview

The CMD281C3 is a negative controlled, wideband GaAs MMIC 2-bit digital attenuator housed in a leadless 3x3 mm surface mount package. Each bit of the attenuator is controlled by a single voltage of either 0 V or -5 V. The attenuator bit values are 2 dB and 4 dB, for a total attenuation of 6 dB. The CMD281C3 has a low insertion loss of 1.5 dB at 10 GHz and the attenuation accuracy is typically 0.1 dB step error. The CMD281C3 is a 50 ohm matched design which eliminates the need for RF port matching.

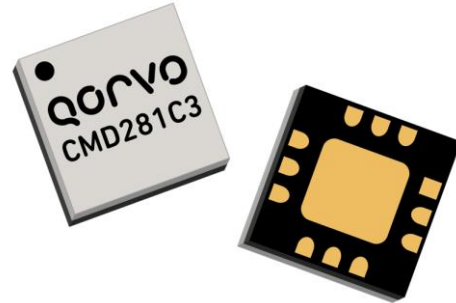

### Functional Block Diagram

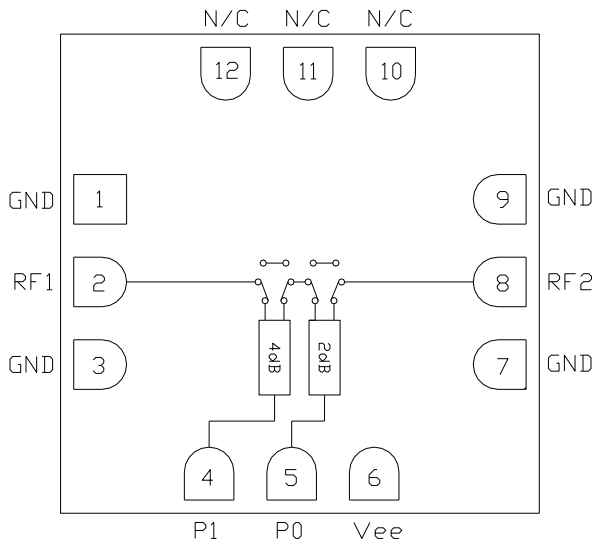

### Key Features

- Wideband Performance
- Low Insertion Loss
- 6 dB Attenuation Range
- Pb-Free RoHs Compliant 3x3 QFN Package

### Ordering Information

Part No.	Description
CMD281C3	DC-22 GHz 2-bit Digital Attenuator, 100 Piece 7" Reel
CMD281C3-EVB	Evaluation Board

### Electrical Performance ( $V_{ee} = -5\text{ V}$ , $V_{ctl} = 0 / -5\text{ V}$ , $T_A = 25\text{ }^\circ\text{C}$ , $F = 10\text{ GHz}$ )

Parameter	Min	Typ	Max	Units
Frequency Range		DC - 22		GHz
Insertion Loss		1.5		dB
Attenuation Range		6		dB
Input Return Loss		17		dB
Output Return Loss		17		dB
Input P0.1dB		28		dBm
Input IP3		42		dBm
Switching Speed		25		ns

## Absolute Maximum Ratings

Parameter	Rating
Bias Voltage, $V_{ee}$	-8 V
Control Voltage, $V_{ctl}$	-8 V
RF Input Power	+27 dBm
Thermal Resistance, $\theta_{JC}$	122 °C/W
Operating Temperature	-40 to 85 °C
Storage Temperature	-55 to 150 °C

Exceeding any one or combination of the maximum ratings may cause permanent damage to the device.

## Recommended Operating Conditions

Parameter	Min	Typ	Max	Units
$V_{ee}$	-5.5	-5	-2.5	V

Electrical performance is measured at specific test conditions. Electrical specifications are not guaranteed over all recommended operating conditions.

## Truth Table

Control Voltage Input		Attenuation State RF1 - RF2 (dB)
P0 2 dB	P1 4 dB	
Low	Low	Reference (insertion loss)
High	Low	2
Low	High	4
High	High	6

## Control Voltage

State	Bias Condition
High	$V_{ee} \pm 0.3$ V
Low	$0 \pm 0.3$ V

## Electrical Specifications $V_{ee} = -5$ V, $V_{ctl} = 0/-5$ V, $T_A = 25$ °C)

Parameter	Min	Typ	Max	Min	Typ	Max	Min	Typ	Max	Units
Frequency Range	DC - 10			10 - 18			18 - 22			GHz
Insertion Loss		1.2	2		1.5	2.6		1.6	2.7	dB
Attenuation Range		6			6			6		dB
Attenuation Accuracy		0.15	0.3		0.5	0.8		0.8	1.6	dB
Input Return Loss		20			12			10		dB
Output Return Loss		20			12			12		dB
Input P0.1dB		28			28			28		dBm
Input IP3		42			42			42		dBm

Note: Specification applies to major states

Typical Performance

Insertion Loss versus Temperature

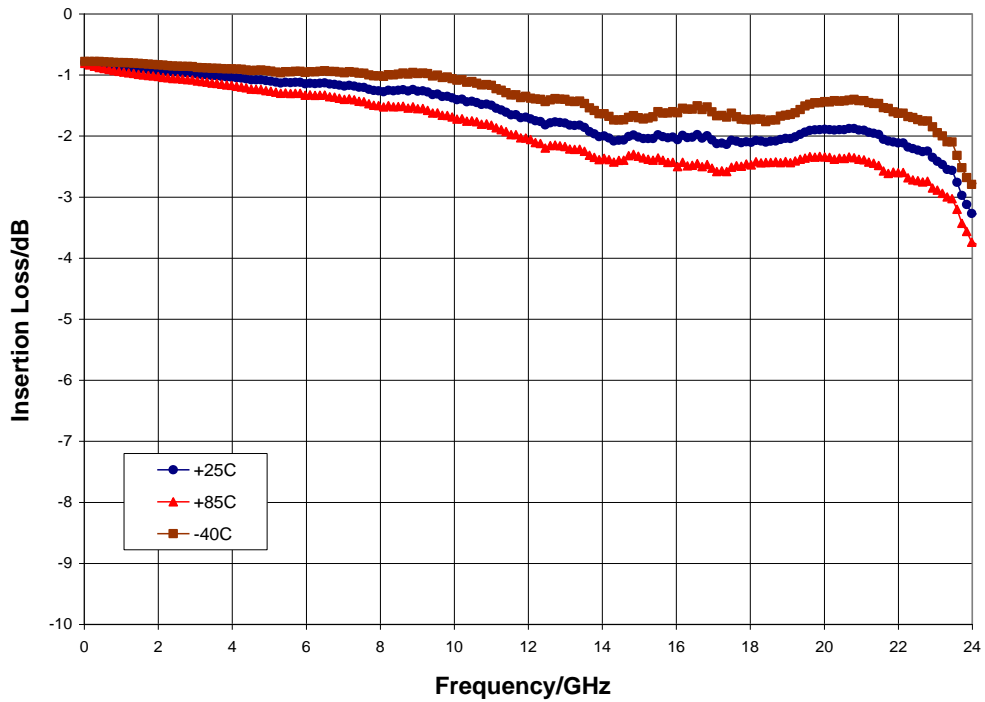

Normalized Attenuation (all states), T<sub>A</sub> = 25 °C

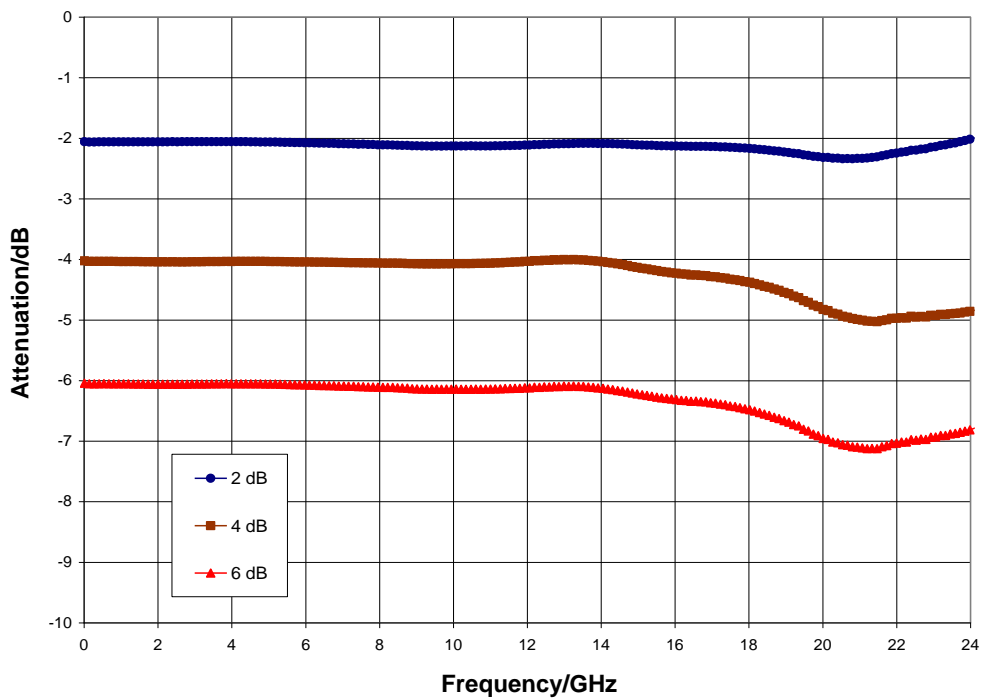

Typical Performance

Input Return Loss (all states),  $T_A = 25\text{ }^\circ\text{C}$

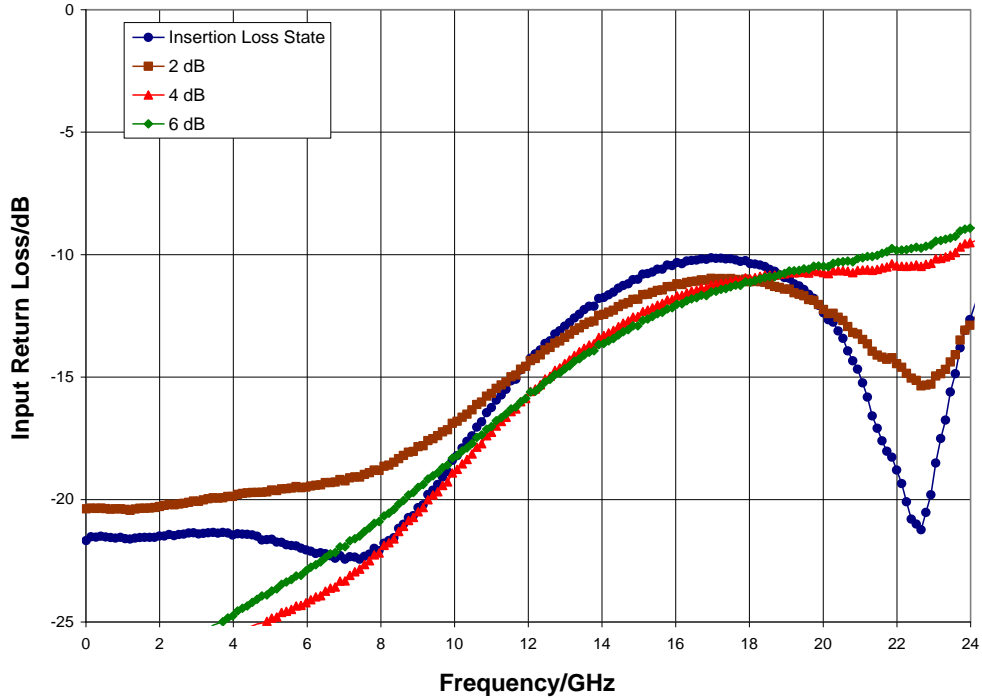

Output Return Loss (all states),  $T_A = 25\text{ }^\circ\text{C}$

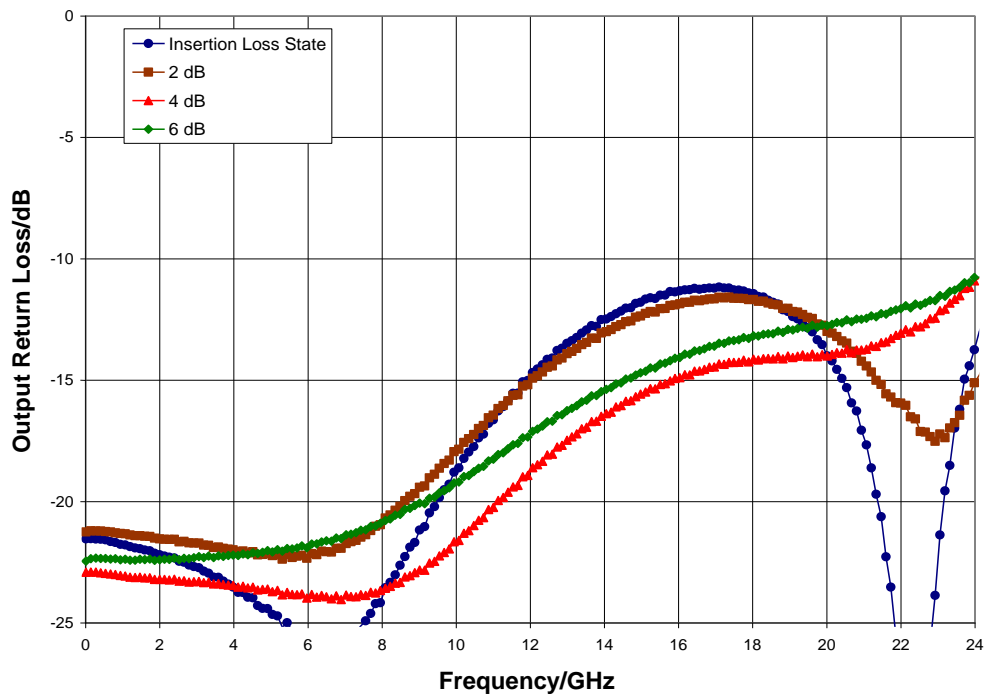

Typical Performance

Bit Error versus Frequency,  $T_A = 25\text{ }^\circ\text{C}$

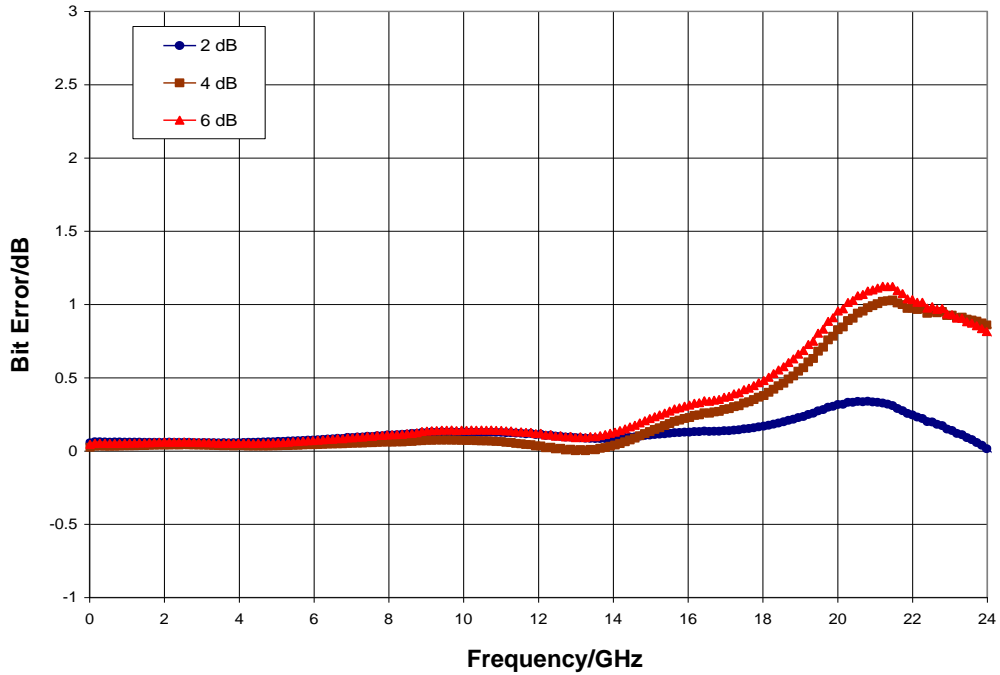

Relative Phase versus Frequency,  $T_A = 25\text{ }^\circ\text{C}$

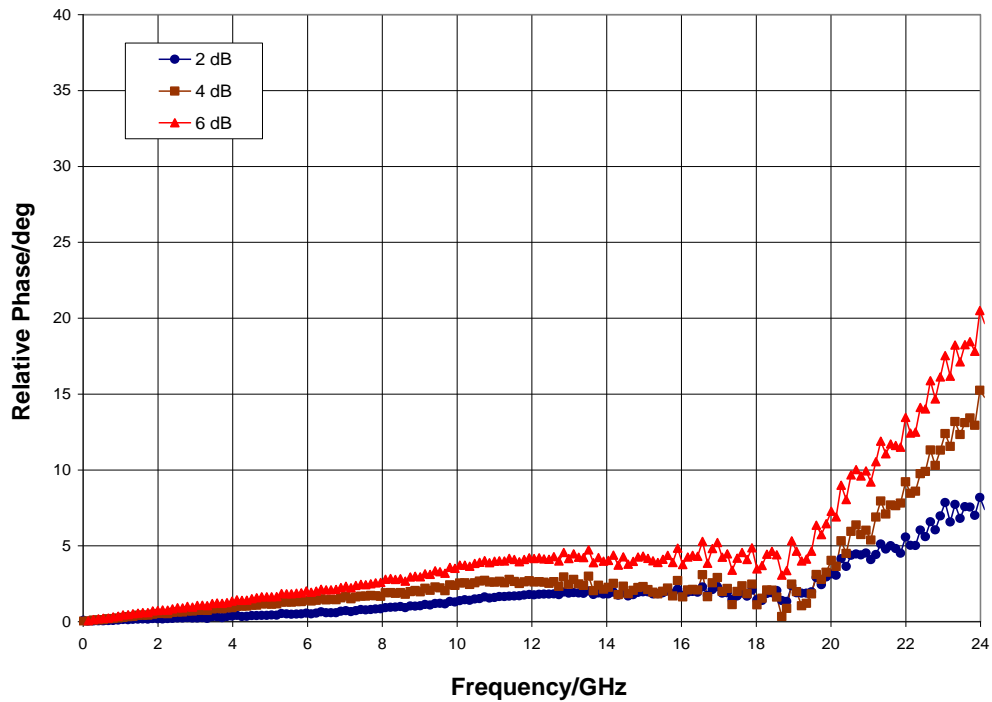

Typical Performance

Input Power for 0.1 dB Compression (insertion loss state)

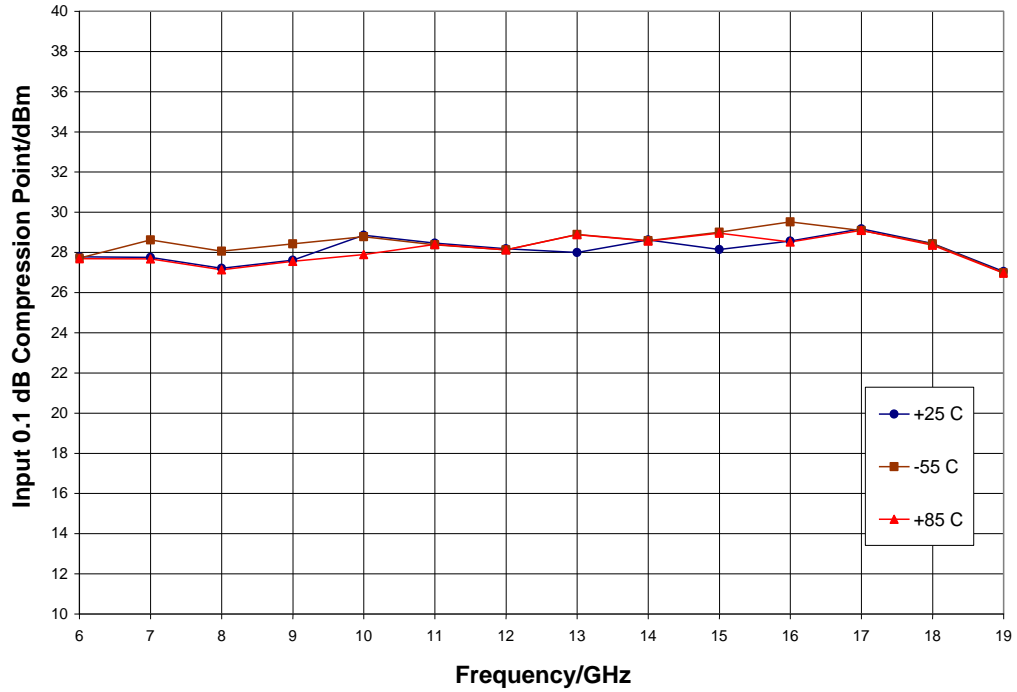

Input IP3 versus Temperature (insertion loss state)

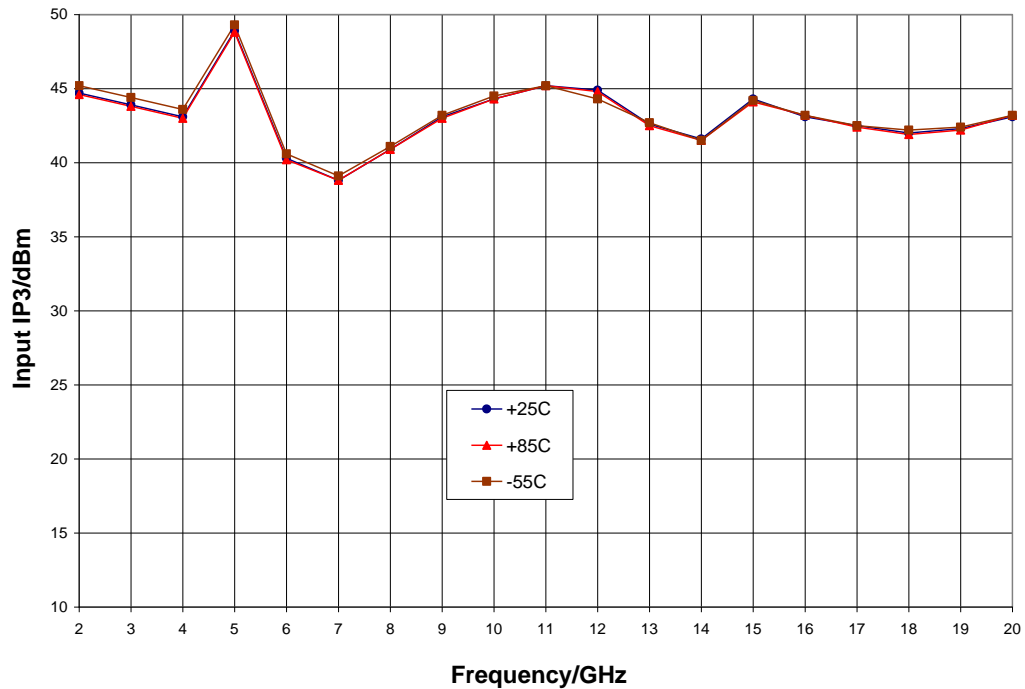

## Mechanical Information

### Package Information and Dimensions

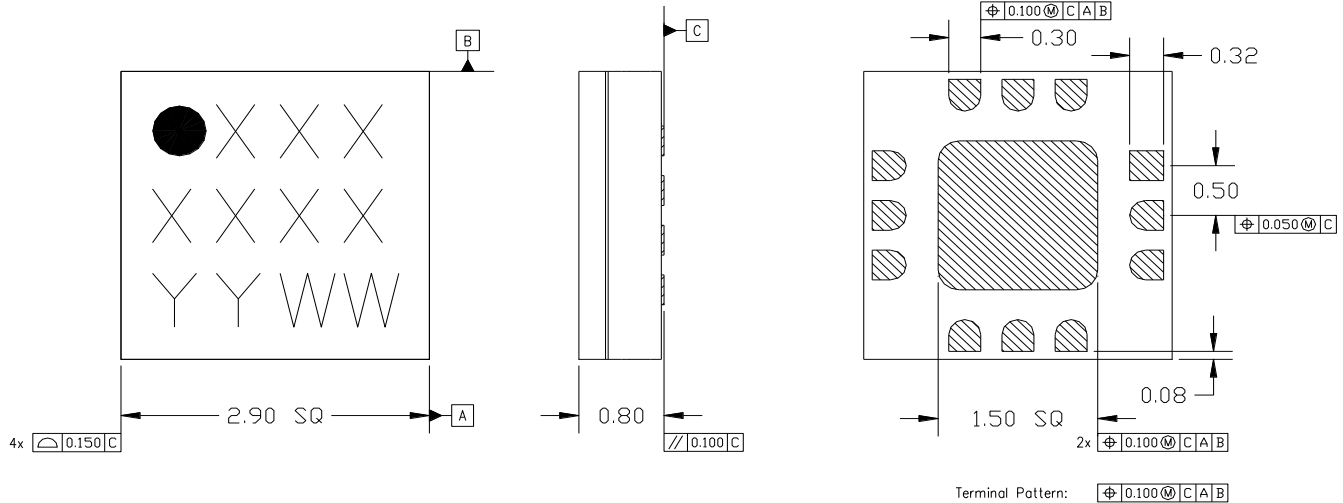

**Notes:**

1. All dimensions shown in mm.
2. Material: Black alumina
3. Lead finish
  - 3.1. Ni: 8.89um max, 1.27um min
  - 3.2. Pd: 0.17um max, 0.07um min
  - 3.3. Au: 0.254um max, 0.03um min
4. Marking
  - 4.1. Line 1: Part number
    - 4.1.1. Example: CMD281C3 shall be marked as 281
  - 4.2. Line 2: Lot number
  - 4.3. Line 3: Date code - Last 2 digits of the year of manufacture followed by a 2 digit week code
5. Alternate pin #1 identifier is a single square pad
6. Alternate die paddle may have chamfered corners

### Recommended PCB Land Pattern

Qorvo recommends that the user develop the land pattern that will provide the best design for proper solder reflow and device attach for their specific application. Please review Qorvo Application Note AN 105 for a recommended land pattern approach.

### Recommended Solder Reflow Profile

Qorvo recommends screen printing with belt furnace reflow to ensure proper solder reflow and device attach. Please review Qorvo Application Note AN 102 for a recommended solder reflow profile.

## Pin Description

### Pin Diagram

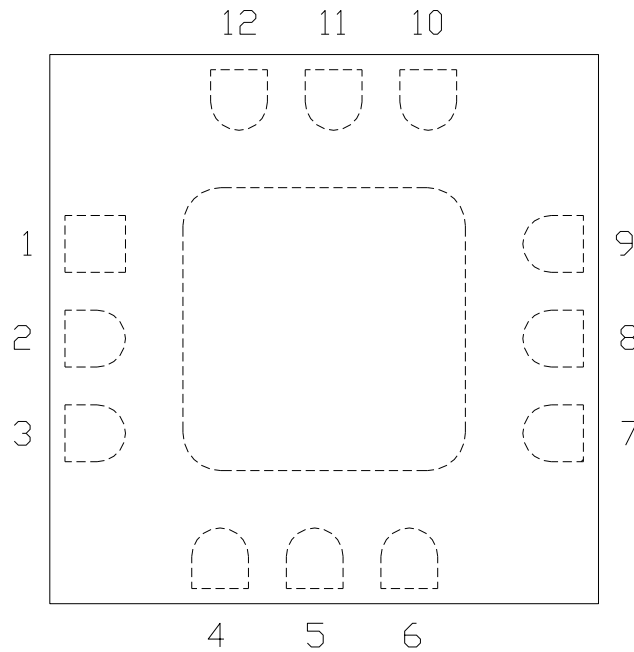

### Functional Description

Pad	Function	Description	Schematic
1, 3, 7, 9 and die paddle	Ground	Connect to RF / DC ground	
2, 8	RF1, RF2	50 ohm matched	
4, 5	P1, P0	Bit control voltages, see truth table for values	
6	V <sub>ee</sub>	Negative bias -5 V	
10 - 12	N/C	No connection required These pins may be connected to RF / DC ground	



## Applications Information

### Evaluation Board

The circuit board shown has been developed for optimized assembly at Qorvo. A sufficient number of via holes should be used to connect the top and bottom ground planes. As surface mount processes vary, careful process development is recommended.

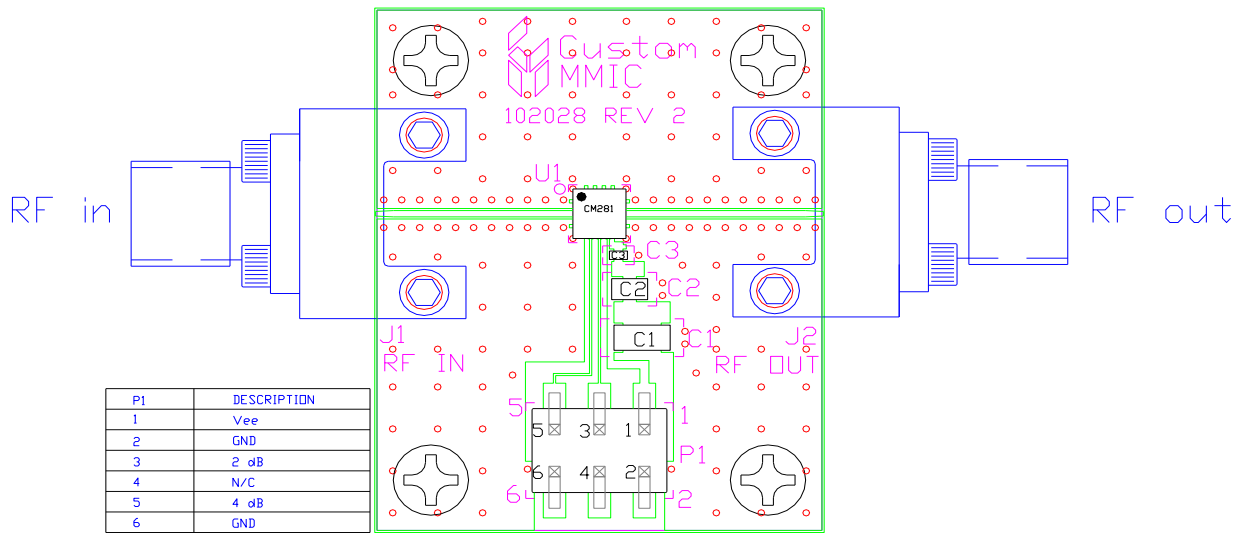

Designator	Value	Description
J1, J2		SMA End Launch Connector
P1		6 Pin Header
C1	0.33 $\mu$ F	Capacitor, Tantalum
C2	1000 pF	Capacitor, 0603
C3	100 pF	Capacitor, 0402
U1		CMD281C3 DATT
PCB		102028 Evaluation PCB

**GaAs MMIC devices are susceptible to damage from Electrostatic Discharge. Proper precautions should be observed during handling, assembly and test.**

## Handling Precautions

Parameter	Rating	Standard
ESD – Human Body Model (HBM)	Class 1A	ESDA / JEDEC JS-001-2012
MSL – Moisture Sensitivity Level	Level 1	JEDEC standard IPC/JEDEC J-STD-020



Caution!  
ESD-Sensitive Device

## RoHS Compliance

This part is compliant with 2011/65/EU RoHS directive (Restrictions on the Use of Certain Hazardous Substances in Electrical and Electronic Equipment) as amended by Directive 2015/863/EU.

This product also has the following attributes:

- Lead Free
- Antimony Free
- TBBP-A (C<sub>15</sub>H<sub>12</sub>Br<sub>4</sub>O<sub>2</sub>) Free
- SVHC Free
- Halogen Free
- PFOS Free

## Contact Information

For the latest specifications, additional product information, worldwide sales and distribution locations:

**Web:** [www.qorvo.com](http://www.qorvo.com)

**Tel:** 1-844-890-8163

**Email:** [customer.support@qorvo.com](mailto:customer.support@qorvo.com)

## Important Notice

The information contained in this Data Sheet and any associated documents (“Data Sheet Information”) is believed to be reliable; however, Qorvo makes no warranties regarding the Data Sheet Information and assumes no responsibility or liability whatsoever for the use of said information. All Data Sheet Information is subject to change without notice. Customers should obtain and verify the latest relevant Data Sheet Information before placing orders for Qorvo® products. Data Sheet Information or the use thereof does not grant, explicitly, implicitly or otherwise any rights or licenses to any third party with respect to patents or any other intellectual property whether with regard to such Data Sheet Information itself or anything described by such information.

DATA SHEET INFORMATION DOES NOT CONSTITUTE A WARRANTY WITH RESPECT TO THE PRODUCTS DESCRIBED HEREIN, AND QORVO HEREBY DISCLAIMS ANY AND ALL WARRANTIES WITH RESPECT TO SUCH PRODUCTS WHETHER EXPRESS OR IMPLIED BY LAW, COURSE OF DEALING, COURSE OF PERFORMANCE, USAGE OF TRADE OR OTHERWISE, INCLUDING THE IMPLIED WARRANTIES OF MERCHANTABILITY AND FITNESS FOR A PARTICULAR PURPOSE. Without limiting the generality of the foregoing, Qorvo® products are not warranted or authorized for use as critical components in medical, life-saving, or life-sustaining applications, or other applications where a failure would reasonably be expected to cause severe personal injury or death. Applications described in the Data Sheet Information are for illustrative purposes only. Customers are responsible for validating that a particular product described in the Data Sheet Information is suitable for use in a particular application.

© 2022 Qorvo US, Inc. All rights reserved. This document is subject to copyright laws in various jurisdictions worldwide and may not be reproduced or distributed, in whole or in part, without the express written consent of Qorvo US, Inc. | QORVO® is a registered trademark of Qorvo US, Inc.