

## 71-86GHz Single Side Band Mixer

### GaAs Monolithic Microwave IC

#### Description

The CHM1080-98F is a multifunction monolithic mixer, which integrates a balanced sub-harmonic cold FET mixer, with a LO buffer. It is usable both for up-conversion and down-conversion and also compatible with Baseband configuration.

It is designed for the E-band telecommunication application, particularly well suited for the new generation of high capacity backhaul.

The circuit is manufactured with a pHEMT process, 0.10µm gate length.

It is available in chip form.

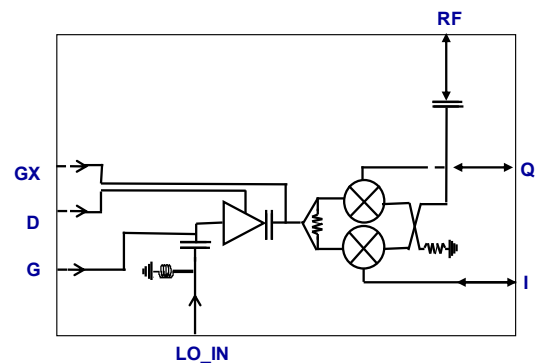

#### Main Features

- Broadband RF performances: 71-86GHz
- -11dB Conversion Gain
- 40dB 2LO isolation
- 10dBm Input Power at 1dB compression
- DC bias: Vd=3.5V @Id=90mA
- Chip size 3.43x1.5x0.07mm

Conversion Gain

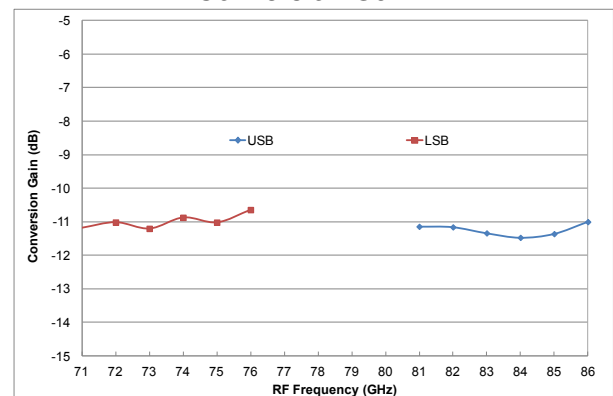

#### Main Electrical Characteristics

Tamb.= +25°C

Symbol	Parameter	Min	Typ	Max	Unit
F <sub>RF</sub>	RF Frequency	71		86	GHz
F <sub>IF</sub>	IF frequency	DC		12	GHz
G <sub>c</sub>	Conversion gain		-11		dB
RFin P1dB	RF input power @1dB comp.		10		dBm

## Electrical Characteristics

Tamb.= +25°C, Vd = 3.5V

Symbol	Parameter	Min	Typ	Max	Unit
F <sub>RF</sub>	RF Frequency range	71		86	GHz
F <sub>LO</sub>	LO Frequency range	34.5		44	GHz
F <sub>IF</sub>	IF output Frequency	DC	6	12	GHz
P <sub>LO</sub>	LO Input Power		2		dBm
G <sub>c</sub>	Conversion Gain <sup>(1)</sup>		-11		dB
R <sub>LO</sub>	LO Input return loss		10		dB
LO/ RF	LO Isolation on RF port		17		dB
2LO/ RF	2LO Isolation on RF port		16		dB
2LO/ RF	2LO Isolation on RF port with DC voltage on I/ Q ( V <sub>I</sub> & V <sub>Q</sub> ) <sup>(2)</sup>		40		dB
Im_rej	Image rejection <sup>(1)</sup>		15		dBc
IFin P1dB	IF Input power @1dB comp.		0		dBm
RFin P1dB	RF input power @1dB comp.		10		dBm
V <sub>I</sub> & V <sub>Q</sub>	DC voltage on I & Q <sup>(3)</sup>	-500		500	mV
I <sub>d</sub>	Drain current (I <sub>d</sub> LO Buffer) <sup>(4)</sup>		90		mA
D	DC drain voltage (LO Buffer)		3.5		V
G	DC gate voltage (LO Buffer )		-2.2		V
GX	Mixer DC gate voltage		-2		V

<sup>(1)</sup> An external combiner 90° is required on I / Q.

<sup>(2)</sup> In baseband configuration, a DC voltage on I & Q could be applied to cancel the 2LO leakage

<sup>(3)</sup> V<sub>I</sub> & V<sub>Q</sub> should be tuned independently for each frequency, temperature

<sup>(4)</sup> LO Buffer quiescent current 85mA

These values are representative of on-wafer measurements that are made without bonding wires at the RF & LO ports.

A ribbon (75 μm wide) connection at the RF and LO inputs (see chapter recommended chip assembly) could improve the results.

**Absolute Maximum Ratings** <sup>(1)</sup>T<sub>amb.</sub> = +25°C

Symbol	Parameter	Values	Unit
V <sub>d</sub>	Drain bias voltage	4V	V
I <sub>d</sub>	Drain bias quiescent current	120	mA
V <sub>G</sub> , V <sub>Gx</sub>	Gate bias voltage	-3 to -0.2	V
Pin_LO	Maximum LO peak input power overdrive <sup>(2)</sup>	+10	dBm
T <sub>j</sub>	Junction temperature	175	°C
T <sub>a</sub>	Operating temperature range	-40 to +85	°C
T <sub>stg</sub>	Storage temperature range	-55 to +150	°C

<sup>(1)</sup> Operation of this device above anyone of these parameters may cause permanent damage.

<sup>(2)</sup> Duration < 1s.

**Typical Bias Conditions**T<sub>amb.</sub> = +25°C

Pad name	Pad N°	Parameter	Typical Values	Unit
G	9	LO Buffer DC gate voltage <sup>(1)</sup>	-2.2	V
D	7	LO Buffer DC drain voltage (85mA)	3.5	V
GX	8	Mixer DC gate voltage	-2	V
	6, 7	Not connected		

<sup>(1)</sup> Gate voltage should be adjusted to reach 85mA through pad D.

## Typical on wafer Measurements as Down converter

Tamb.= +25°C, Vd = +3.5V

Measurement conditions, base line:

GX= -2V, Pin\_RF= -15dBm, Pin\_LO= 2dBm, IF Frequency = 10GHz

G tuned for Id\_LO= 85mA ( G close to -2.2V)

USB: RF= 2LO+ IF; LSB: RF= 2LO-IF

Measure with external IF 90° hybrid

### Conversion Gain versus RF Frequency & Mixer Voltage GX

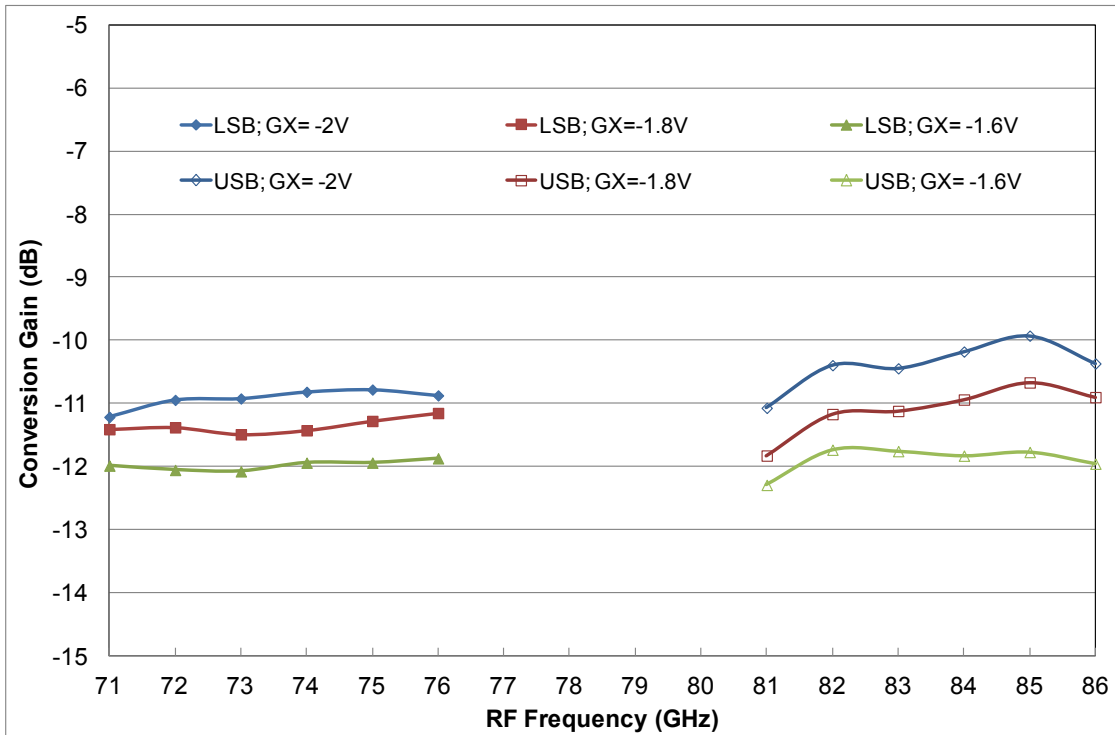

**Typical on wafer Measurements as Down converter**

Tamb.= +25°C, Vd = +3.5V

**Image rejection versus RF Frequency & Mixer Voltage GX**

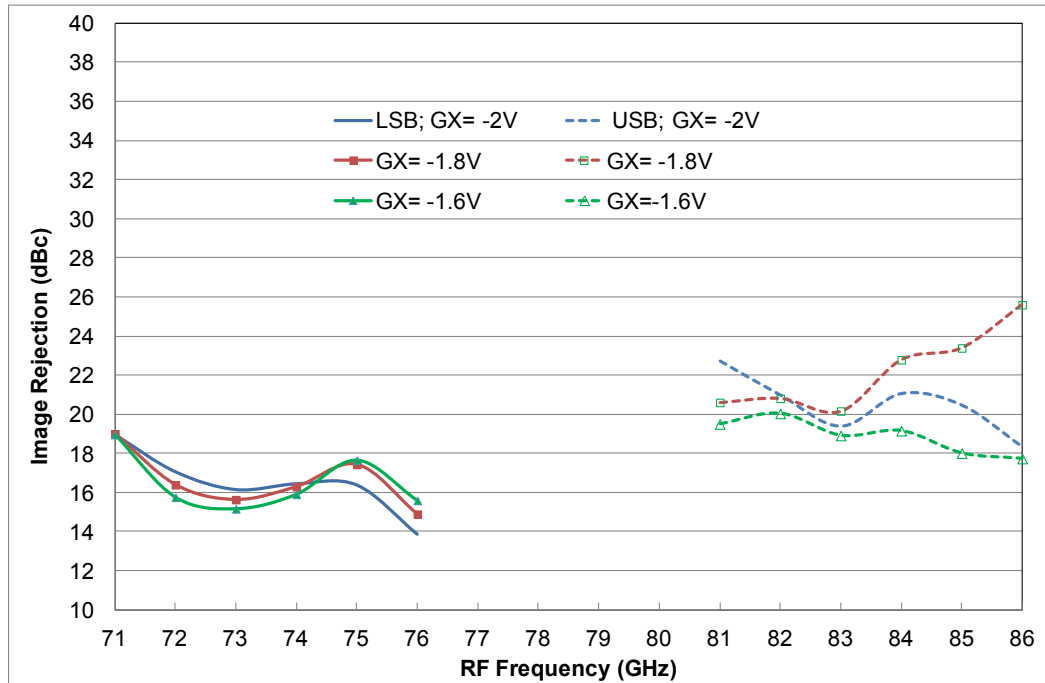

**LO Isolation versus LO Frequency**

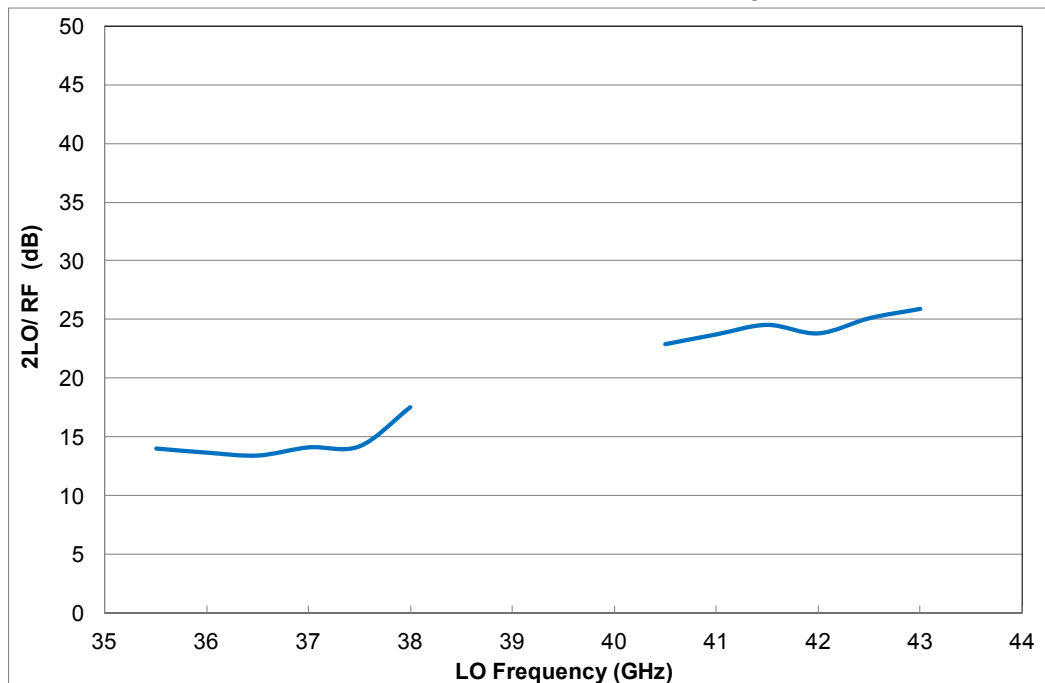

## Typical on wafer Measurements as Down converter

Tamb.= +25°C, Vd = +3.5V

Note: measured without external IF 90° hybrid

Conversion Gain versus RF frequency & IF Frequency

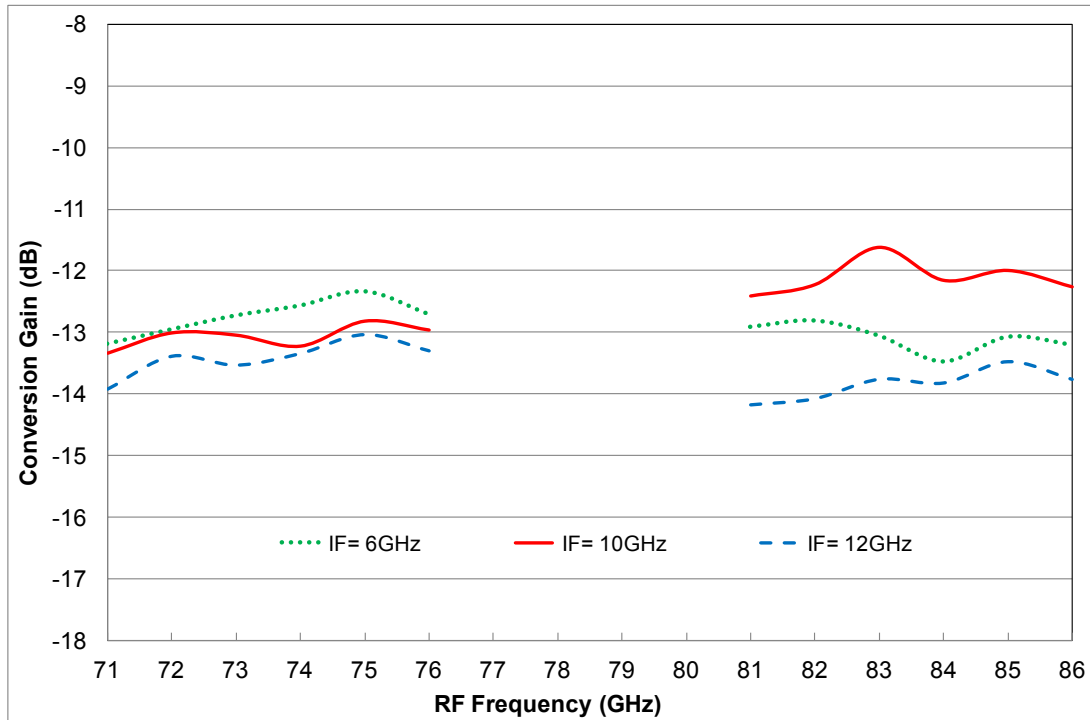

**Typical on wafer Measurements as Up converter**

Tamb.= +25°C, Vd = +3.5V

Measurement conditions, base line:

GX= -2V, Pin\_IF= -10dBm, Pin\_LO= 2dBm, IF Frequency = 6GHz

G tuned for Id\_LO= 85mA ( G close to -2.2V)

USB: RF= 2LO+ IF; LSB: RF= 2LO-IF

Measure with external IF 90° hybrid

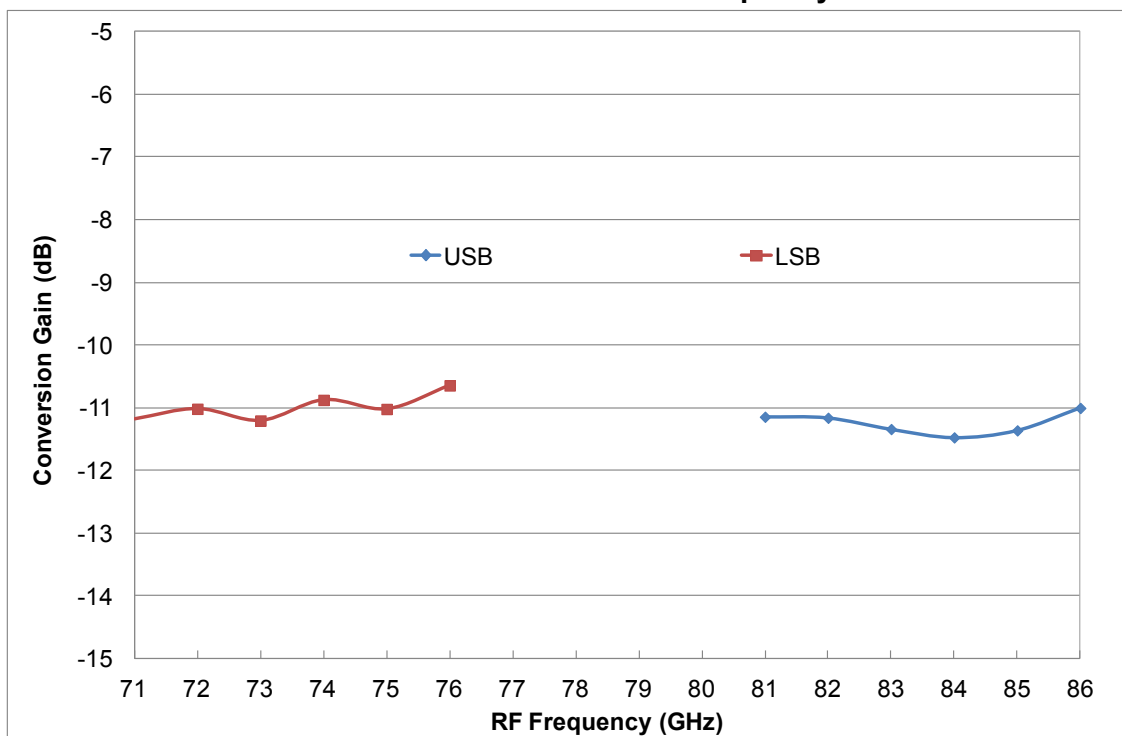
**Conversion Gain versus RF frequency**

## Typical on wafer Measurements as Up converter

Tamb.= +25°C, Vd = +3.5V

### Image rejection versus RF frequency

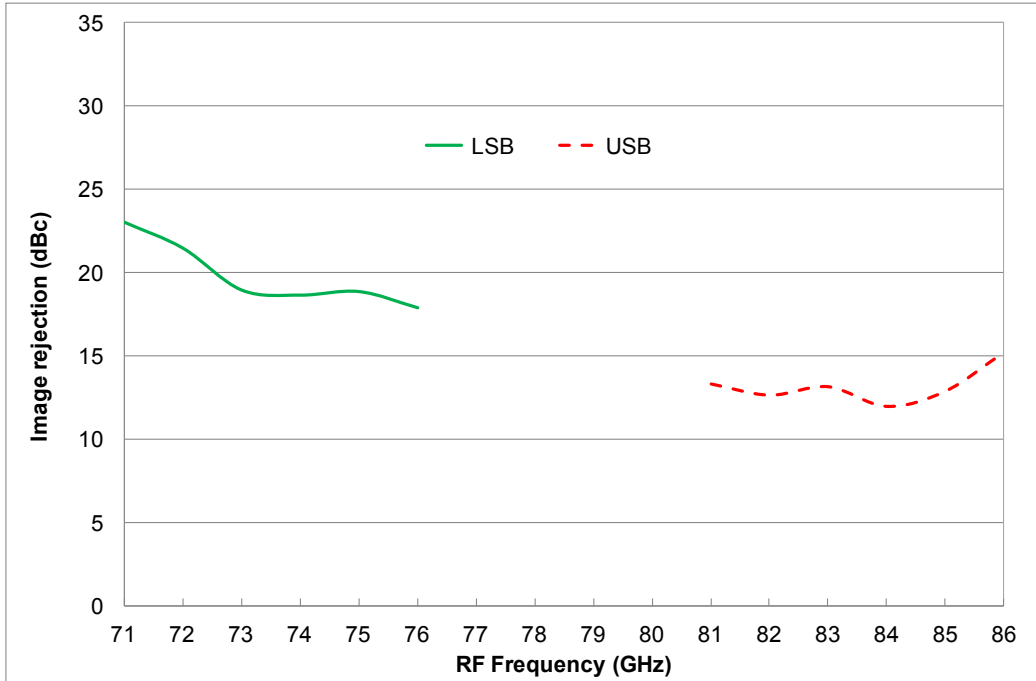

### Isolation versus LO Frequency

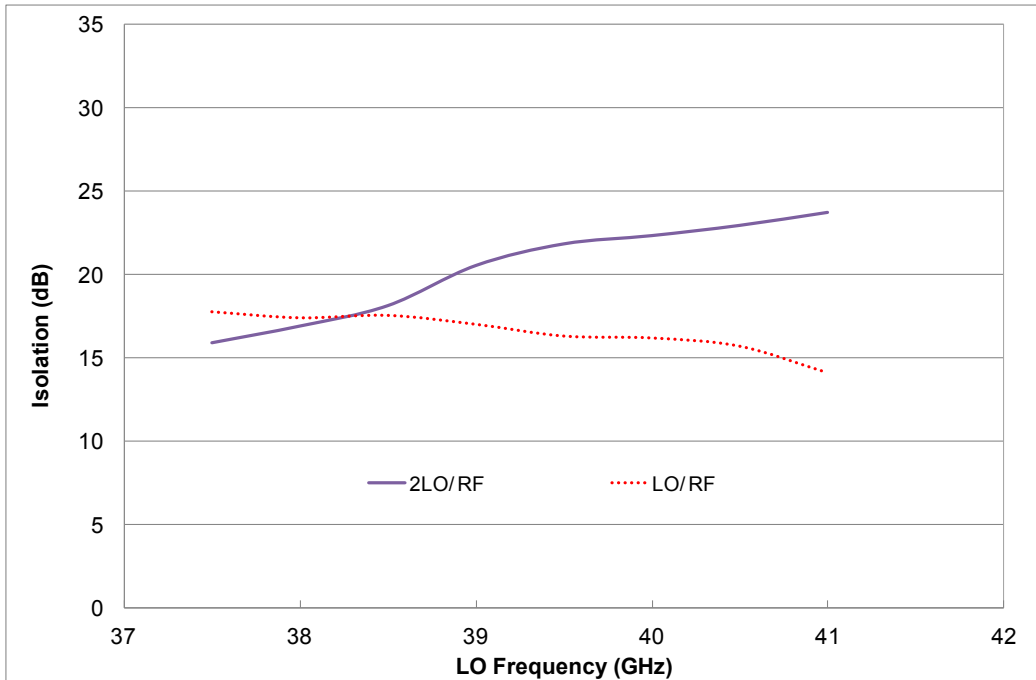



Typical on wafer Measurements as Up converter

Tamb.= +25°C, Vd = +3.5V

Conversion Gain versus LO power

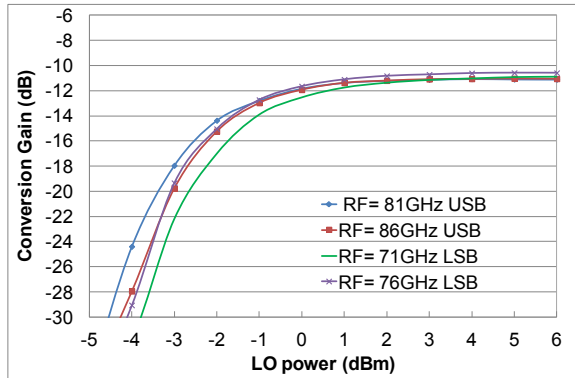

2LO leakage versus LO power

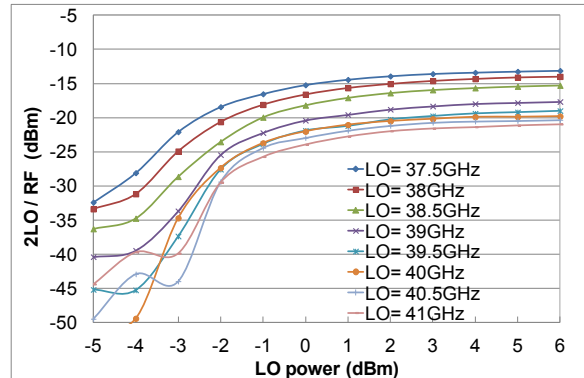

Conversion Gain versus Mixer Voltage

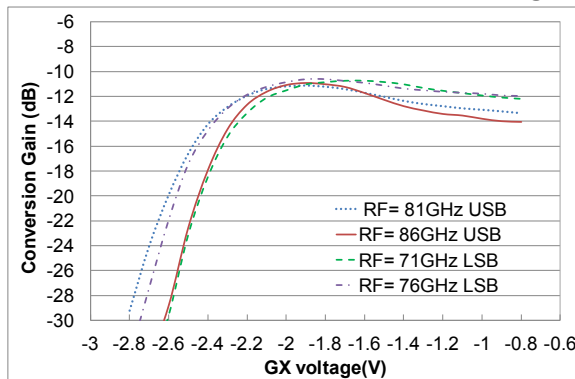

2LO leakage versus Mixer Voltage

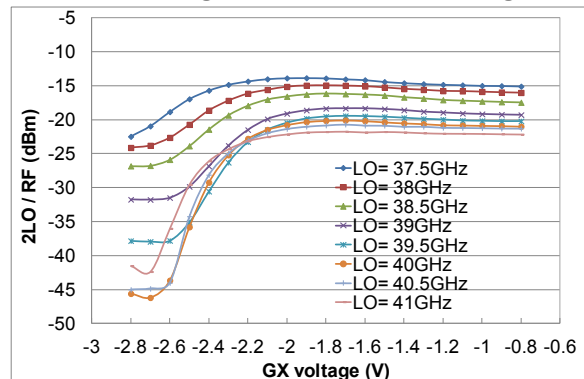

Conversion Gain & LO buffer current versus LO Buffer Voltage G

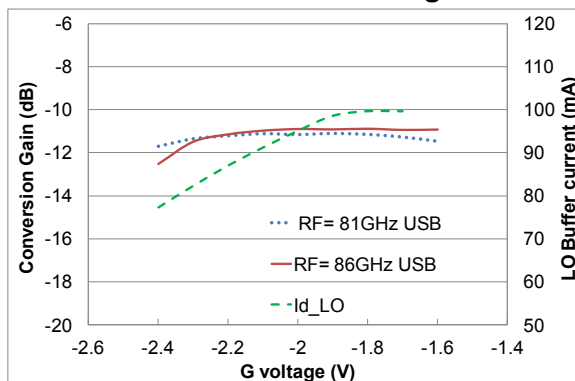

2LO leakage vs LO Buffer Voltage

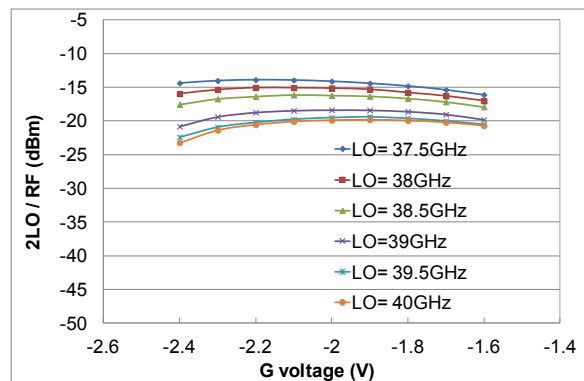

## Typical on wafer Measurements as Up converter

Tamb.= +25°C, Vd = +3.5V

Input power compression versus RF Frequency

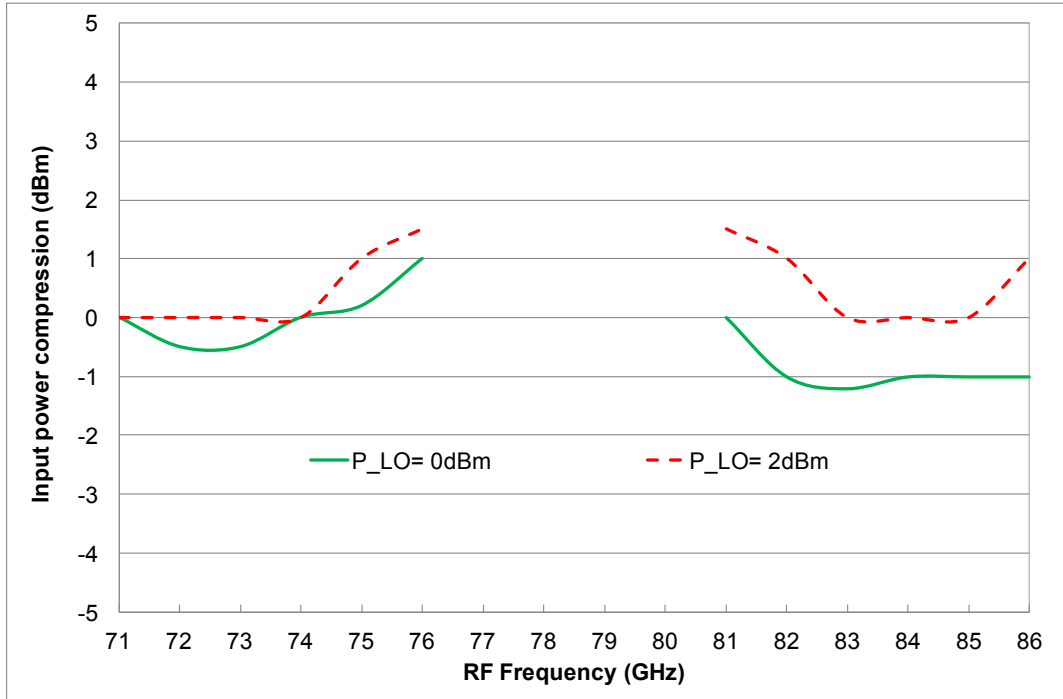

LO return loss versus Frequency

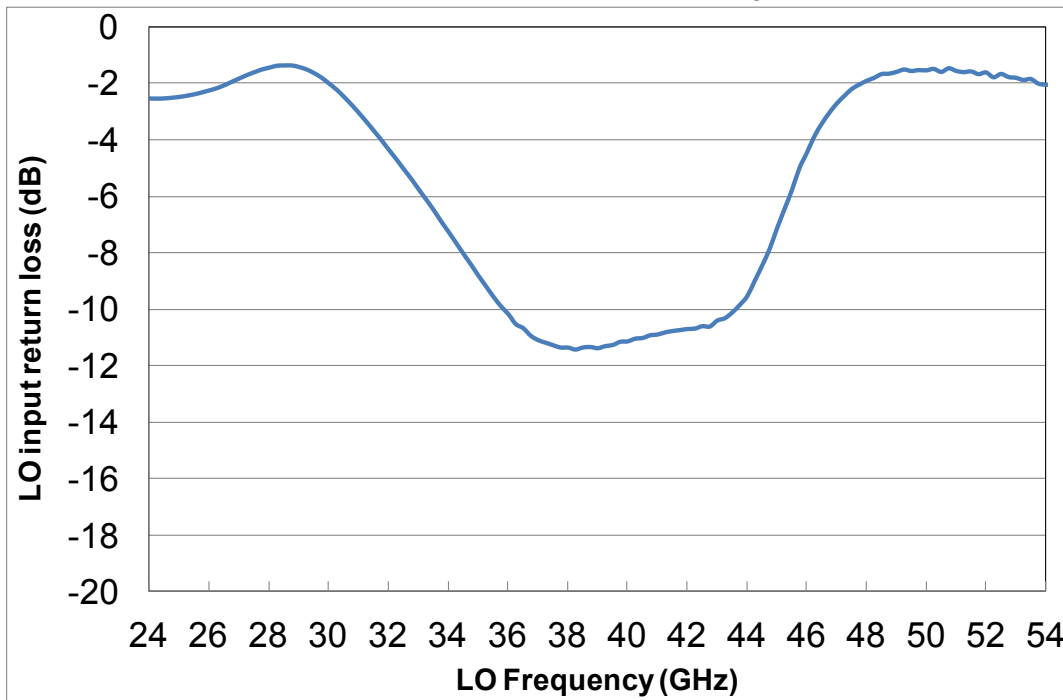

**Typical on wafer Measurements in Baseband configuration**

Tamb.= +25°C, Vd = +3.5V

Measure with low IF at 10MHz, with 90° between I and Q signal

GX= -2V, Pin\_IF= -10dBm, Pin\_LO= 2dBm

G tuned for Id\_LO= 85mA ( G close to -2.2V)

**Conversion Gain & Image Rejection versus RF Frequency**

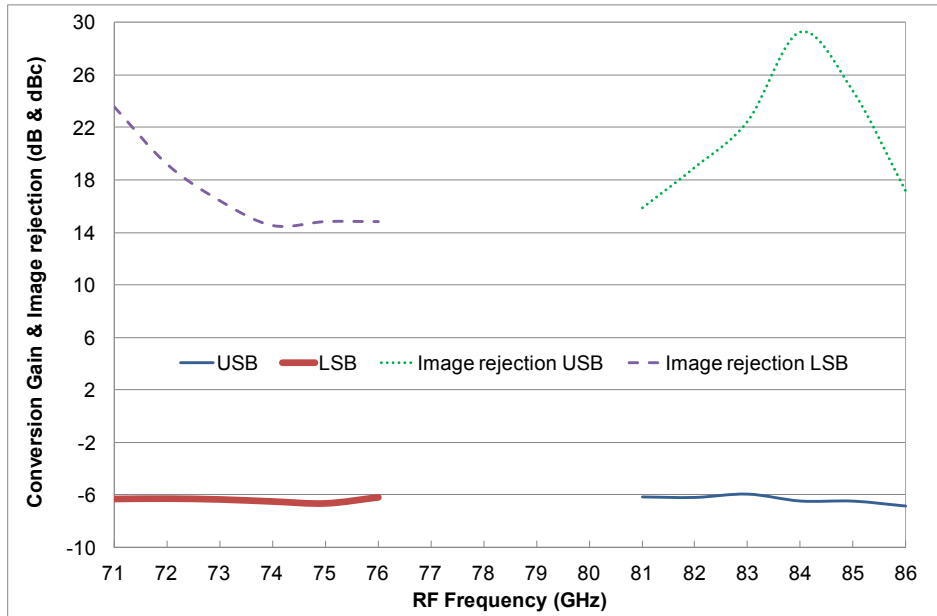

**Isolation versus LO Frequency <sup>(1)</sup>**

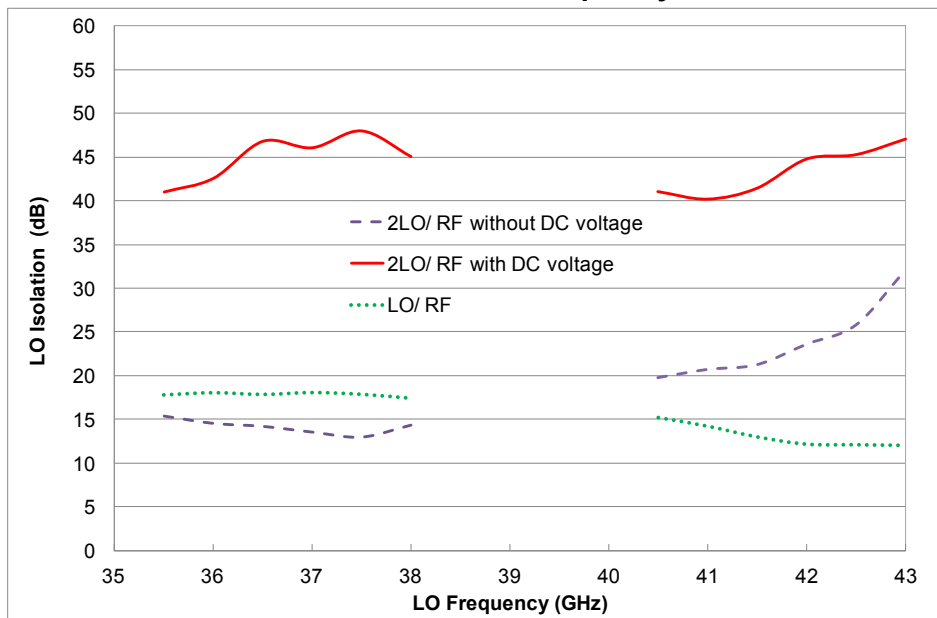

<sup>(1)</sup> In baseband configuration, a DC voltage on I & Q could be applied to cancel the 2LO leakage. V\_I & V\_Q should be tuned independently for each frequency and temperature.

## Mechanical data

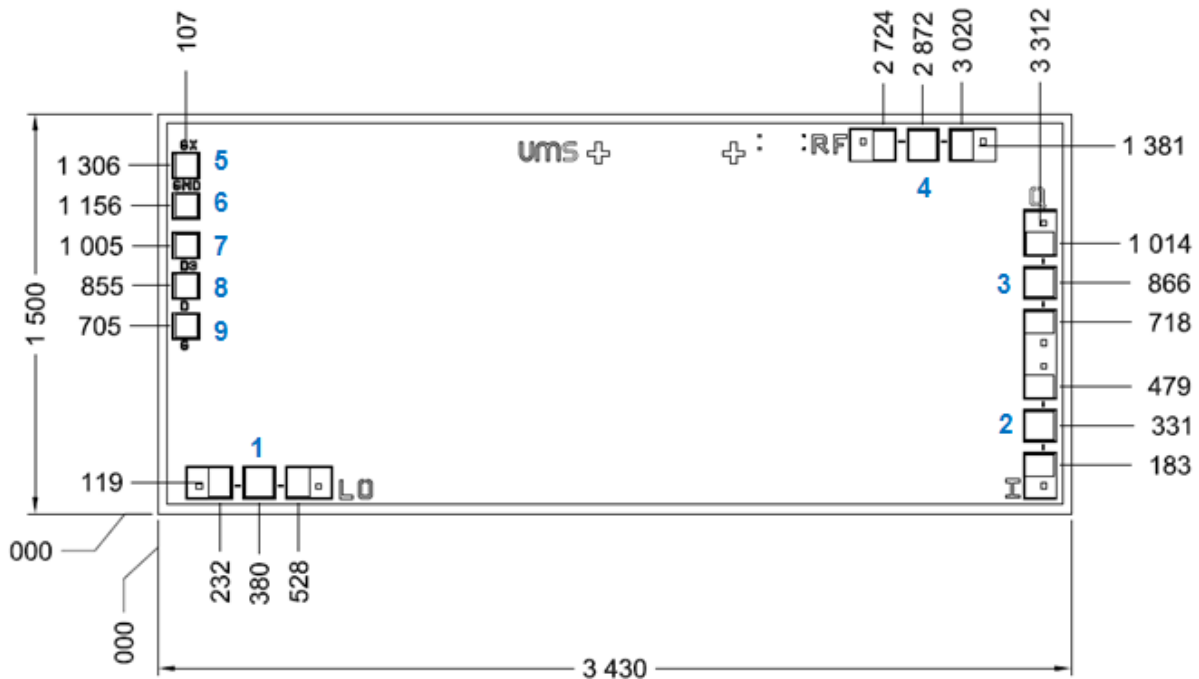

Chip thickness: 70µm.  
 Chip size: 3430x1500 ±35µm  
 All dimensions are in micrometers

RF Pads = 108 x 106 (BCB opening)  
 DC Pads = 86 x 83 (BCB opening)

## Recommended circuit bonding table

Pin number	Pin name	Description	Decoupling
1	LO	LO In	
2	I	IF (I)	
3	Q	IF (Q)	
4	RF	RF in-out	
5	GX	DC Mixer Gate Voltage (-2V)	120pF, 10nF
6, 7		Not connected	
8	D	DC LO Buffer Drain Voltage (3.5V)	120pF, 10nF
9	G	DC LO Buffer Gate Voltage (-2.2V)	120pF, 10nF

## Recommended assembly plan

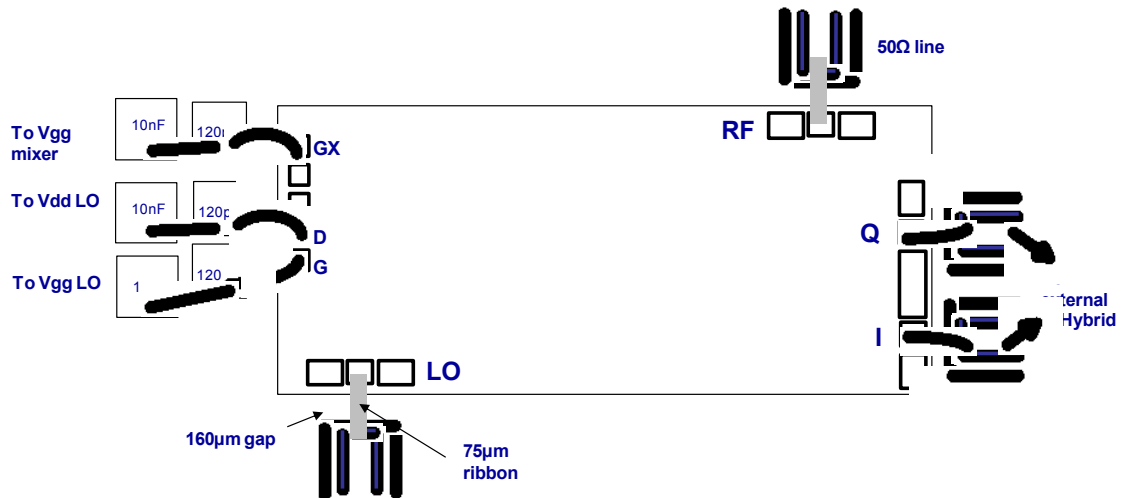

The design integrates a half ribbon (75μm wide) connection at the RF and LO input of the MMIC amplifier compliant with a 50Ω line on GaAs MMIC.

Circuits having to be as close as possible to each other, the ribbon length must be reduced to the achievable minimum (160μm gap between two chips is considered) and the loop height must also be the smallest realizable (80μm).

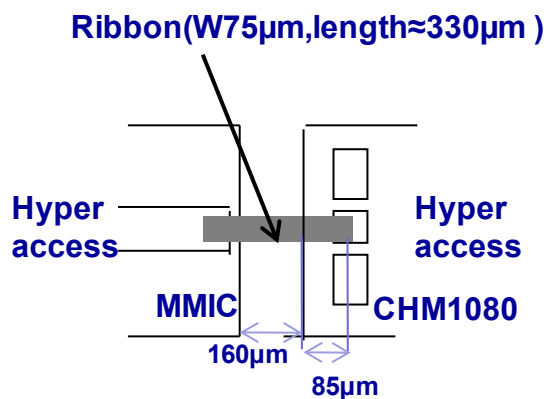

A second solution is the use of double wires (Ø 25μm). In this case, a minimum of two wires and the same chip to chip distance than ribbon solution are necessary to reduce the inductance effect. Nevertheless, simulations have demonstrated an improvement of RF performance for E-band frequency range with the use of ribbon connection instead of wire.

Regarding the connection of the DC pads, a 25μm wedge bonding is preferred.

## DC Schematic

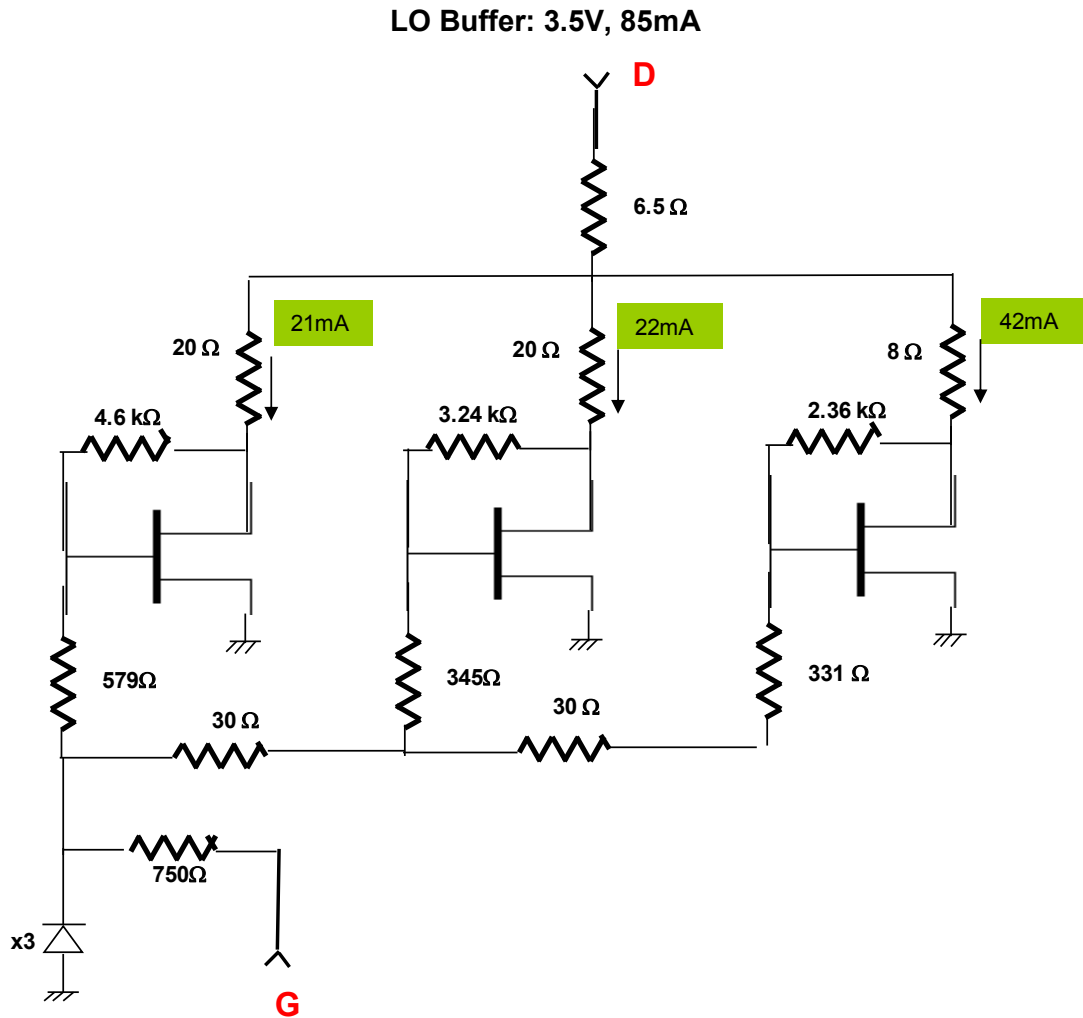

**Notes**

## Recommended ESD management

Refer to the application note AN0020 available at <http://www.ums-gaas.com> for ESD sensitivity and handling recommendations for the UMS products.

## Recommended environmental management

UMS products are compliant with the regulation in particular with the directives RoHS N°2011/65 and REACH N°1907/2006. More environmental data are available in the application note AN0019 also available at <http://www.ums-gaas.com>.

## Ordering Information

Chip form:

CHM1080-98F/00

Information furnished is believed to be accurate and reliable. However **United Monolithic Semiconductors S.A.S.** assumes no responsibility for the consequences of use of such information nor for any infringement of patents or other rights of third parties which may result from its use. No license is granted by implication or otherwise under any patent or patent rights of **United Monolithic Semiconductors S.A.S.** Specifications mentioned in this publication are subject to change without notice. This publication supersedes and replaces all information previously supplied. **United Monolithic Semiconductors S.A.S.** products are not authorised for use as critical components in life support devices or systems without express written approval from **United Monolithic Semiconductors S.A.S.**