

Drawing(mm)

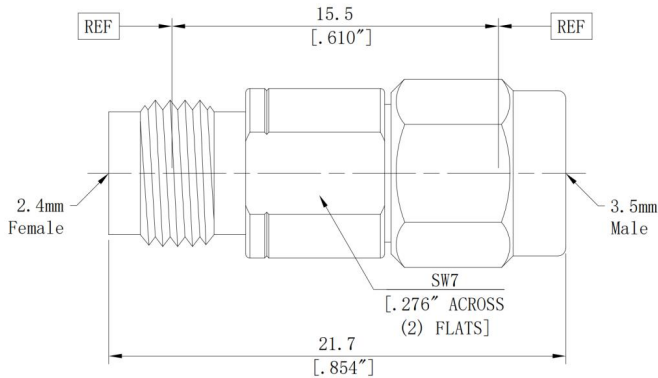

Electrical & Environmental

Impedance	50 ohm
Frequency Range	33 GHz
VSWR	1.15 max
Operating Temp	-55°C to +165°C
Interface	3.5mm per IEC 60169, 2.4mm per IEC 61169

Material

Connector Body	Passivated stainless steel
Center Contact	Gold plated beryllium copper
Insulator	PEI

Typical Test Data

