



Electrical

Impedance	50 ohm
Frequency Range	DC-50 GHz
VSWR	1.34 max
Input Avg Power	20W@25°C ambient, derating linearly to 2W at 100°C
Peak Power	100W (5 micro-sec pulse width, 8% duty cycle)

Mechanical

Connector Body	Passivated stainless steel
Center Contact	1.27um gold plated BeCu
Heat Sink	Black anodized aluminum

Environmental

Operating Temp	-55°C to 100°C
Storage Temp	-55°C to 125°C
RoHS	Compliant

Dimensions(mm)

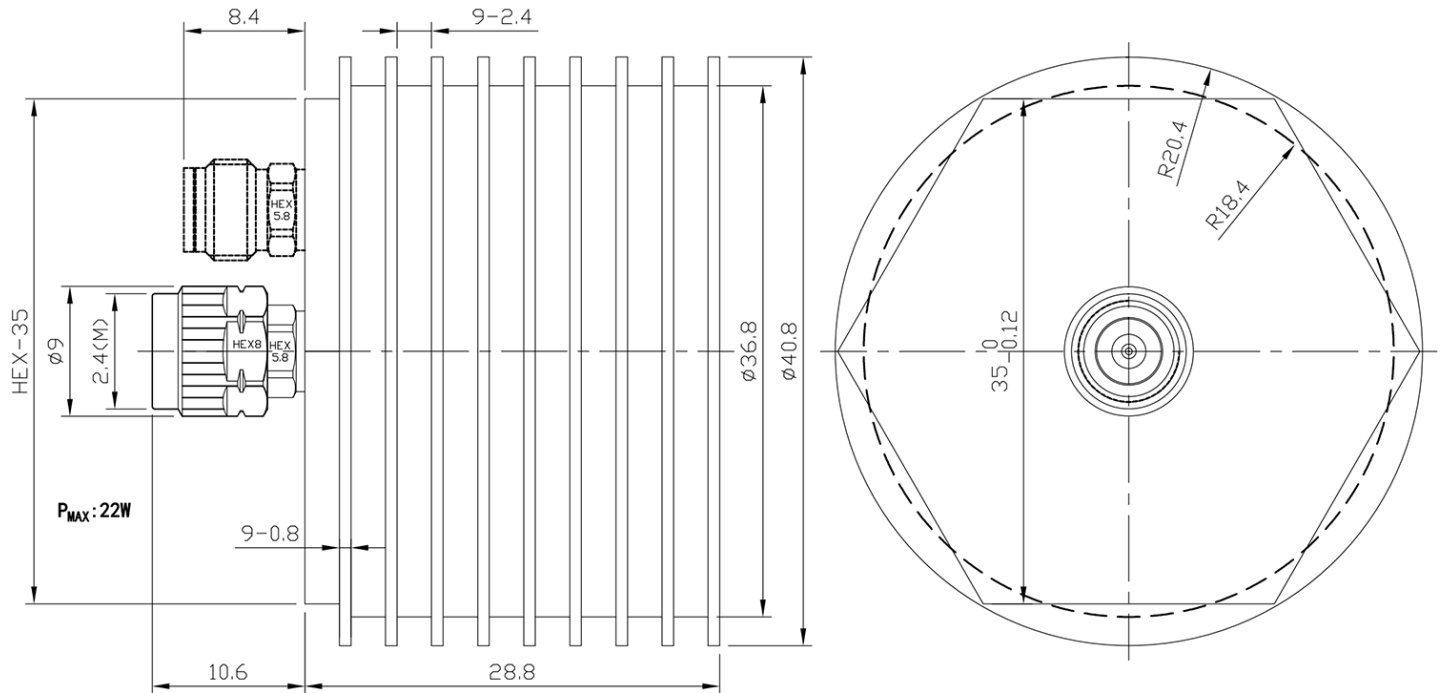

Typical Test Data

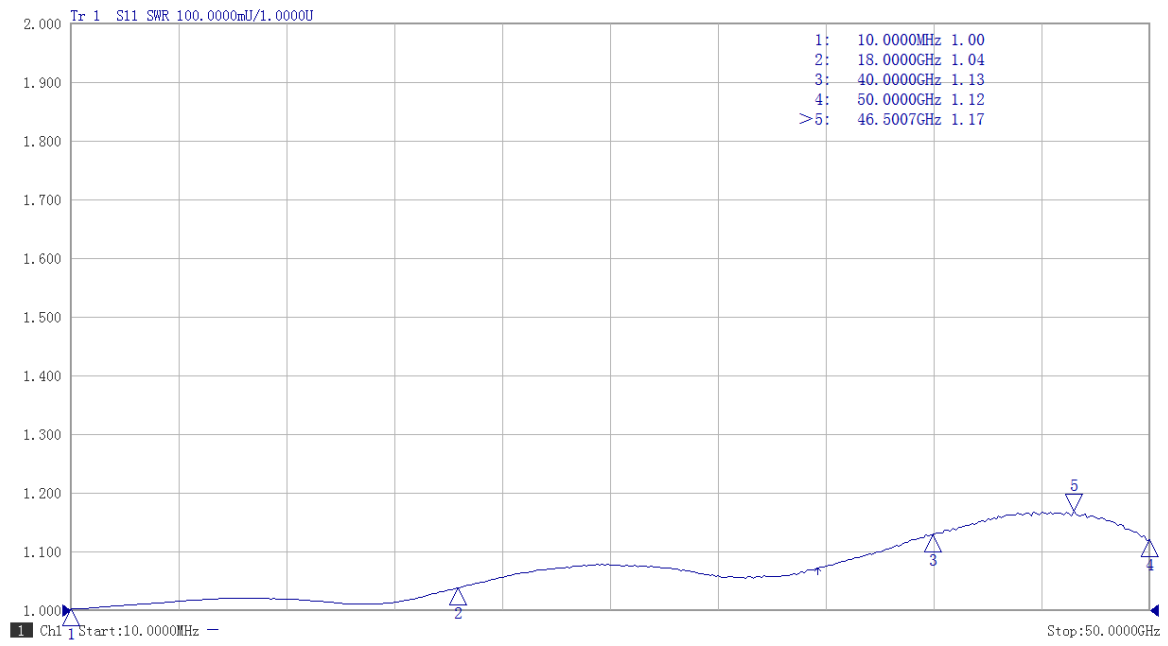

Notes

1. Customized outlines and optimal VSWR available.
2. To maintain best performance, recommended to use fan to keep the case temperature under 85°C.