

Fully Integrated HBT K-band VCO

GaAs Monolithic Microwave IC in QFN package

Description

The CHV3241-QDG is a monolithic multifunction circuit suitable for frequency generation. It integrates an X-band “push-push” oscillator with frequency control (VCO) thanks to base-collector diodes, used as varactors, a K-band buffer amplifier and a divider by 512. All the active devices are internally self-biased.

The circuit is fully integrated on InGaP HBT technology: 2µm emitter length, via holes through the substrate and high Q passive elements.

The chip is delivered in a standard 24 Leads RoHS compliant QFN4x4 package.

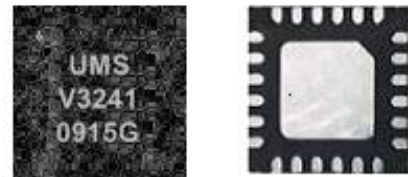

Plastic package

Main Features

- K-band VCO & K-band buffer
- Prescaler/512 generating 24MHz output suitable for software frequency loop
- Prescaler and buffer switching capability with low pulling, for optimum efficiency
- Fully integrated VCO (no external Resonator)
- Low phase noise
- High temperature range
- High output power
- 4th amplifier bias usable for power setting
- High frequency stability
- On chip self biased devices
- RoHS SMD package: 24L-QFN4x4

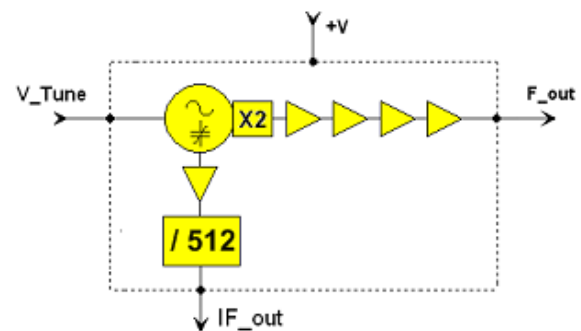

Multifunction block diagram

Main Characteristics

T_{amb.} = +25°C

Symbol	Parameter	Min	Typ	Max	Unit
F _{out}	Specified output frequency range	24	24.125	24.25	GHz
F _{vco}	Oscillator frequency	F _{out} /2			GHz
IF _{out}	Output Intermediate frequency (IF)	F _{out} /1024			GHz
P _{out}	Output power at F _{out}		16		dBm
Pres_P	Output power at (IF)		0		dBm
PN	SSB Phase Noise @ F _{out} @ 100kHz		-94		dBc/Hz

ESD Protection: Electrostatic discharge sensitive device. Observe handling precautions!

Electrical Characteristics

Full temperature and supply voltage range

VCO & Amplifier Part

Symbol	Parameters	Min	Typ	Max	Unit
F_out	Output Frequency range (Operating band)	24		24.25	GHz
F_vco	VCO frequency	F_out/2			
V_Tune	Voltage Tuning range	1		6	V
T_sens	Tuning sensitivity	250	400	725	MHz/V
F_drift	Temperature frequency drift rate		4		MHz/°C
H1	Harmonics 1/2 F_out		-50	-40	dBc
H3	Harmonics 3/2 F_out		-50	-40	dBc
H4	Harmonics 2 F_out		-30	-20	dBc
Pres_Rj	F_out prescaler spurious rejection	45	65		dBc
PN	SSB Phase Noise @ F_out @ 100KHz		-94	-80	dBc/Hz
VSWR	Main Output (F_Out) VSWR		2:1		
L_pull	RF load pulling into 2:1 VSWR all phases			8	MHz
Pull	Prescaler and buffer switching pulling		12		MHz
Push	Bias pushing @ within the V_tune range			250	MHz/V
P_out	Nominal output Power on F_out port	12	16	19	dBm
P_out_V B2_2	Output Power on F_out port @ VB2=2V		9		dBm
+I	Positive supply current		130	170	mA

Prescaler & Buffer Part

Symbol	Parameters	Min	Typ	Max	Unit
IF_out	IF Output Frequency	F_out/1024			GHz
Pres_P	Output Power on 50Ω load	-3	0		dBm
Pres_I	Positive supply current		95	145	mA
VSWR	Prescaler Output (IF) VSWR on 100Ω		2:1		

General

Symbol	Parameters	Min	Typ	Max	Unit
V	Positive supply voltage: VB, V1, VB1, V2, VB2, VD	4.9	5	5.1	V
I	Total Positive supply current: IB1 + IB2 + I1 + I2		225	315	mA
Top	Operating temperature range	-40		+105	°C

All the parameters are specified within F_out specified frequency range.

Remark:

The minimum and maximum values take into account the spread due to the operating temperature and process spread.

These performances have been obtained with the chip in QFN package assembled on the recommended boards (ref. 97836) described in this document. These performances are highly dependent on this environment.

Absolute Maximum Ratings (1)

Tamb = +25°C

Symbol	Parameters	Values	Unit
V_tune	Positive Tuning voltage	10	V
+V	Positive supply voltage	6	V
+ID	Positive supply current (Prescaler)	170	mA
+IB1/+IB2	Positive supply current (amplifiers 2 & 3)	50 / 60	mA
+I1/+I2	Positive supply current (VCO+amplifier 1)	40 / 50	mA
+IB	Positive supply current (prescaler's buffer)	10	mA
Top	Operating temperature range (2)	-40 to +105	°C
Tstg	Storage temperature range	-55 to +125	°C

(1) Operation of this device above anyone of these parameters may cause permanent damage.

(2) Temperature of the back side of the QFN package

Typical QFN measurements on board 97836 (QFN RF Pin plan)

Remark: The temperature mentioned below is taken at the back side of the QFN package.

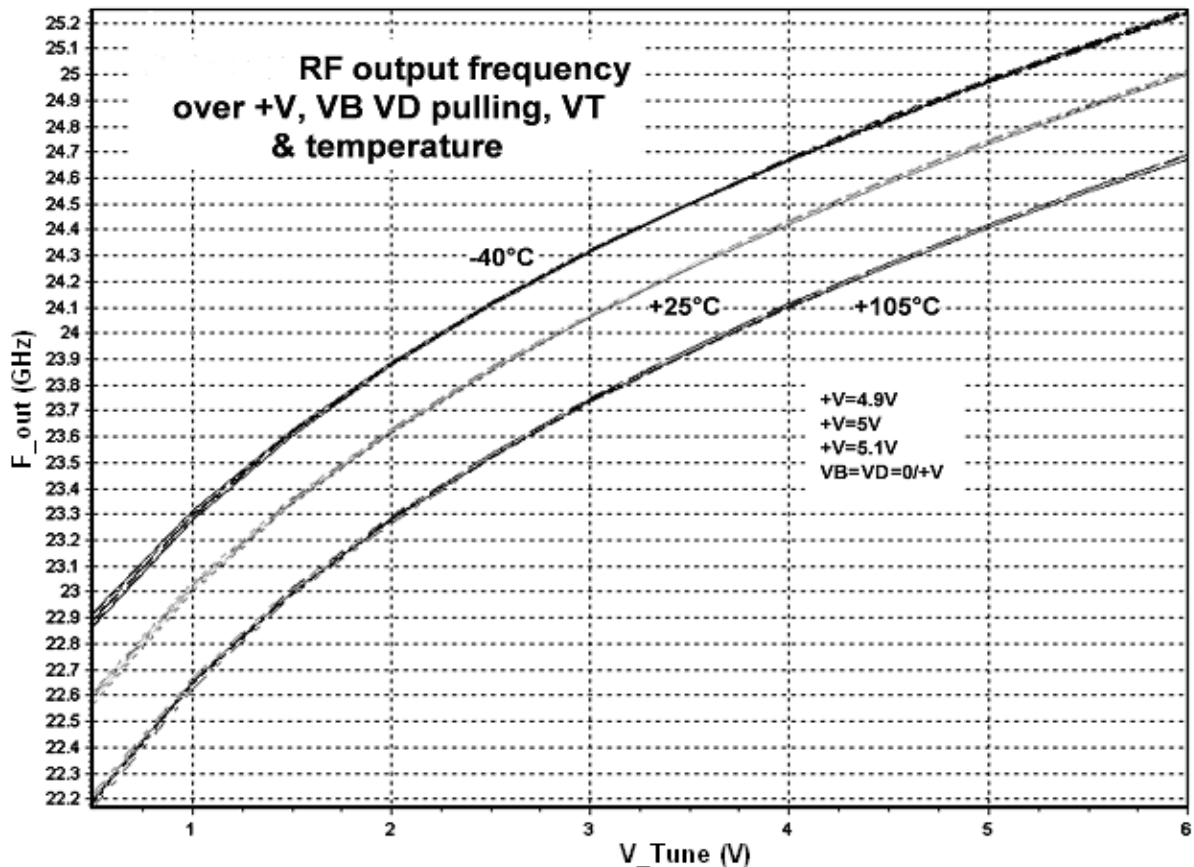
F_out frequency versus V_tune, +V & Top

F_out sensitivity versus V_tune & Top @ +V = 5V

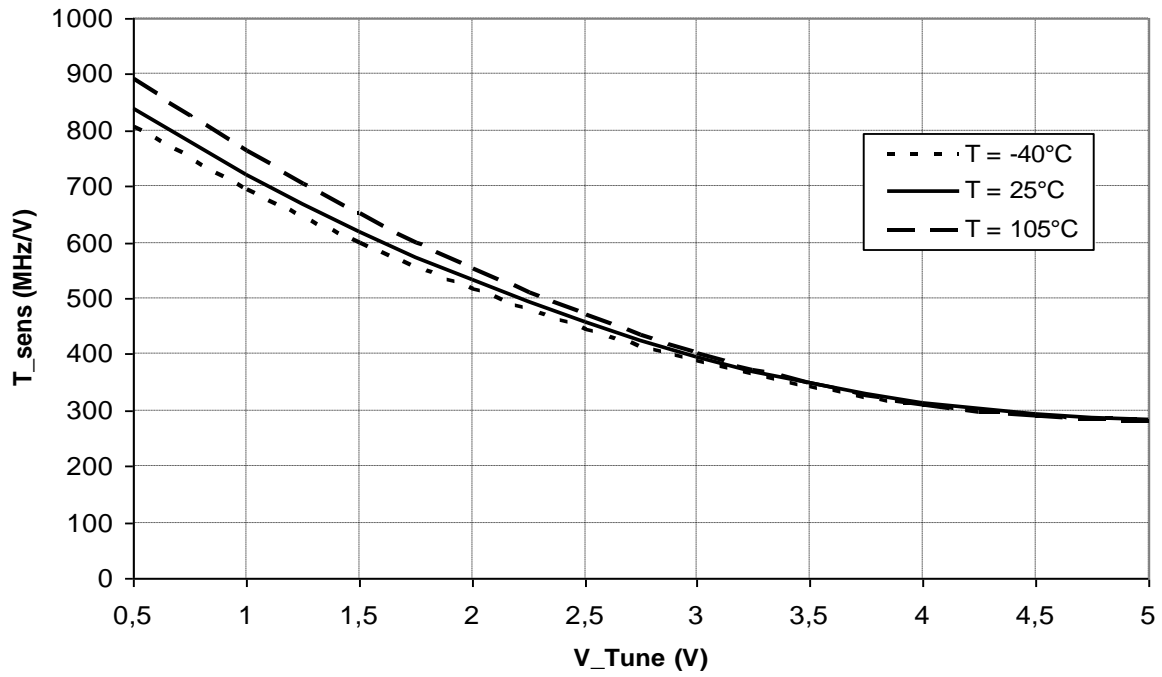

F_out output power versus V_tune

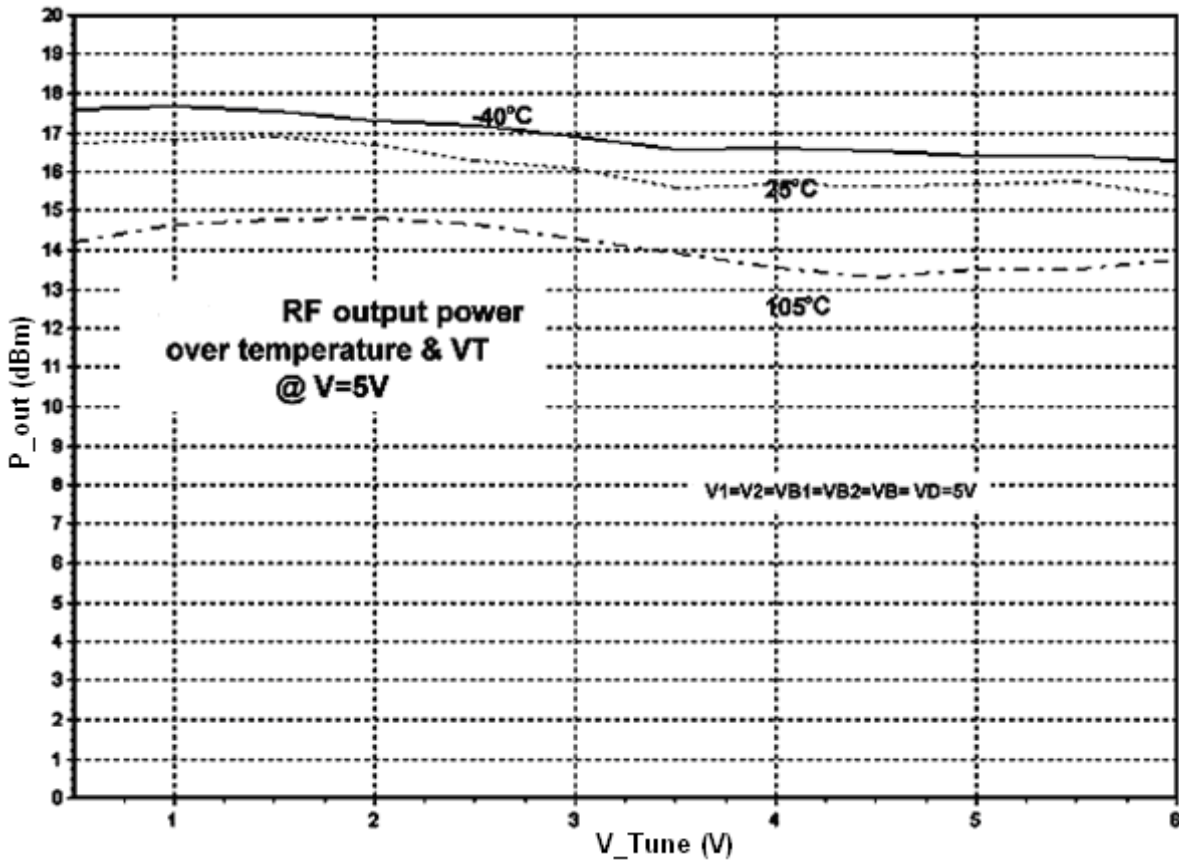

IF_out output power versus V_tune on 50Ω load

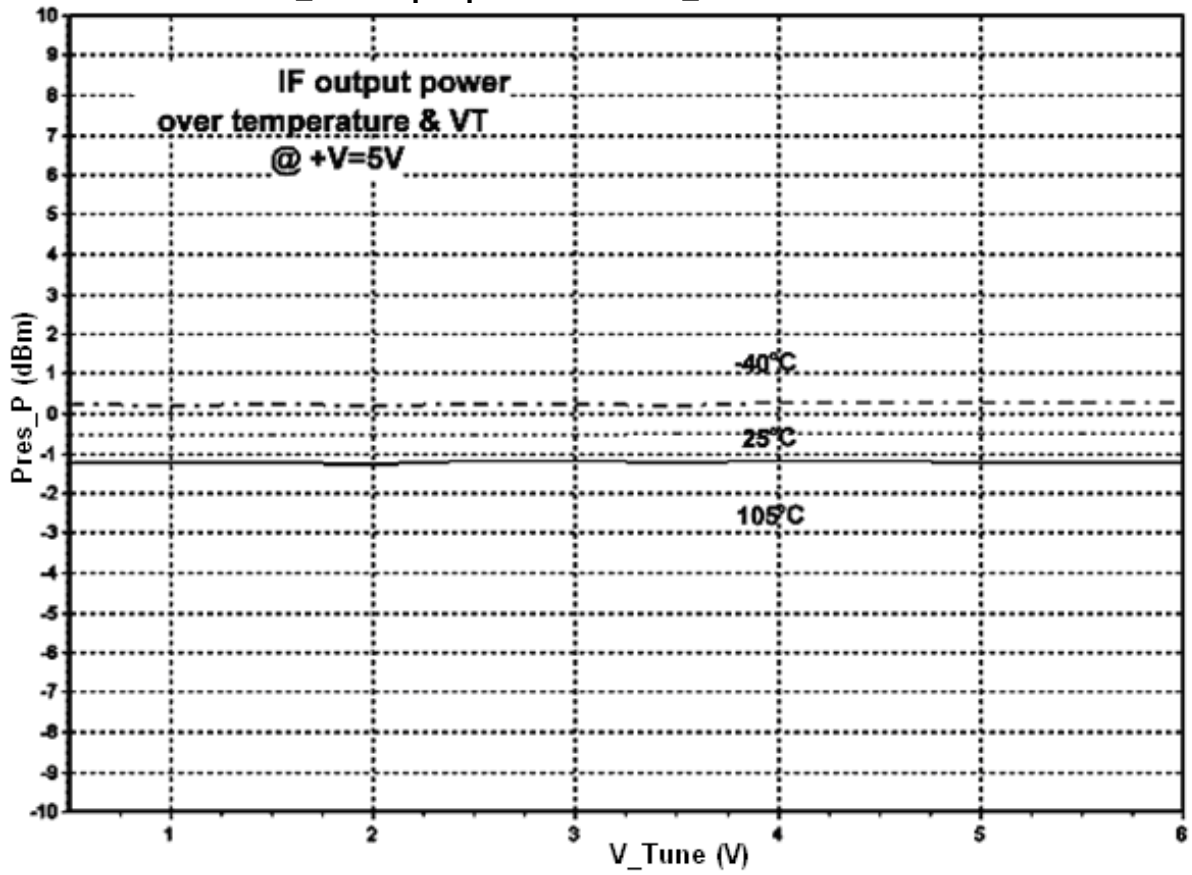

VCO F_out phase Noise versus V_tune

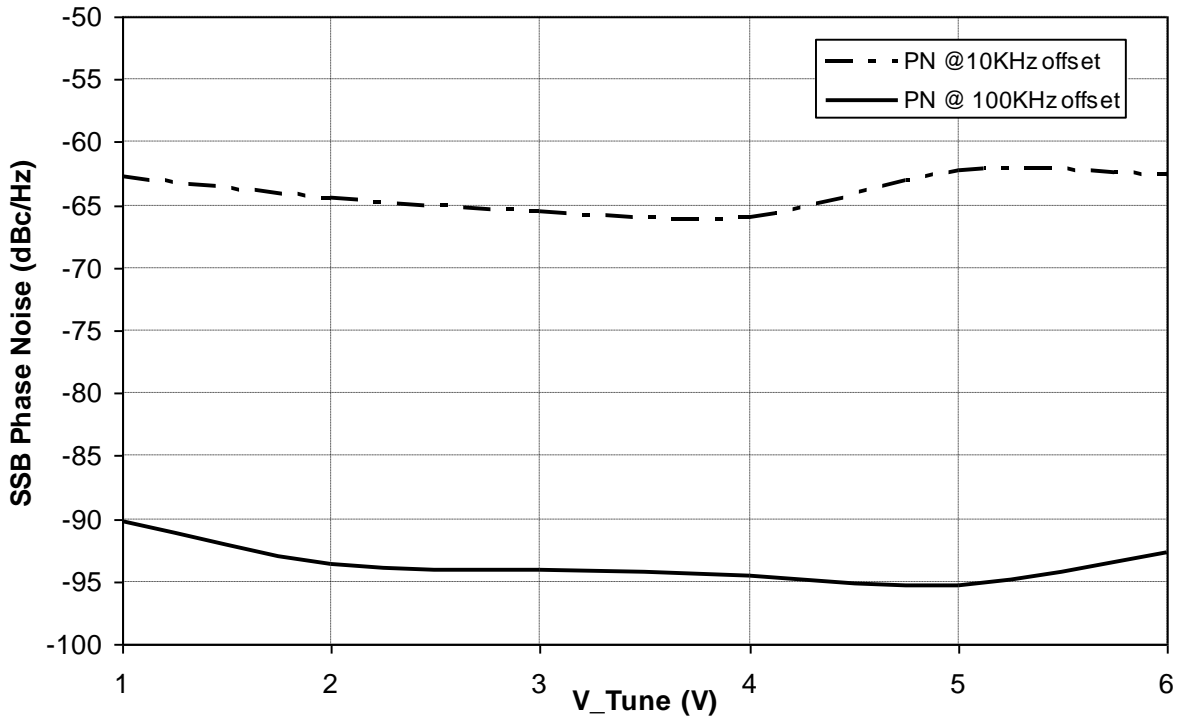

Phase Noise versus Offset frequency from carrier @ Top = +25°C

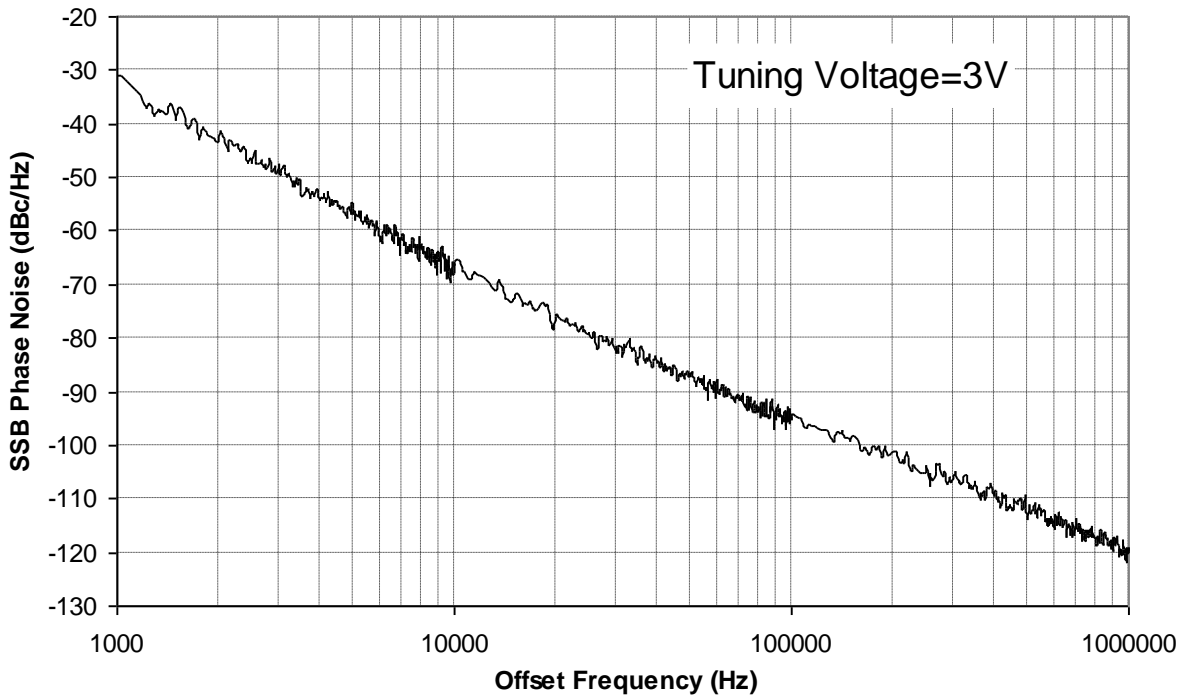

Phase Noise versus Offset frequency from carrier & +V @ Vt = 3V, Top = -40°C

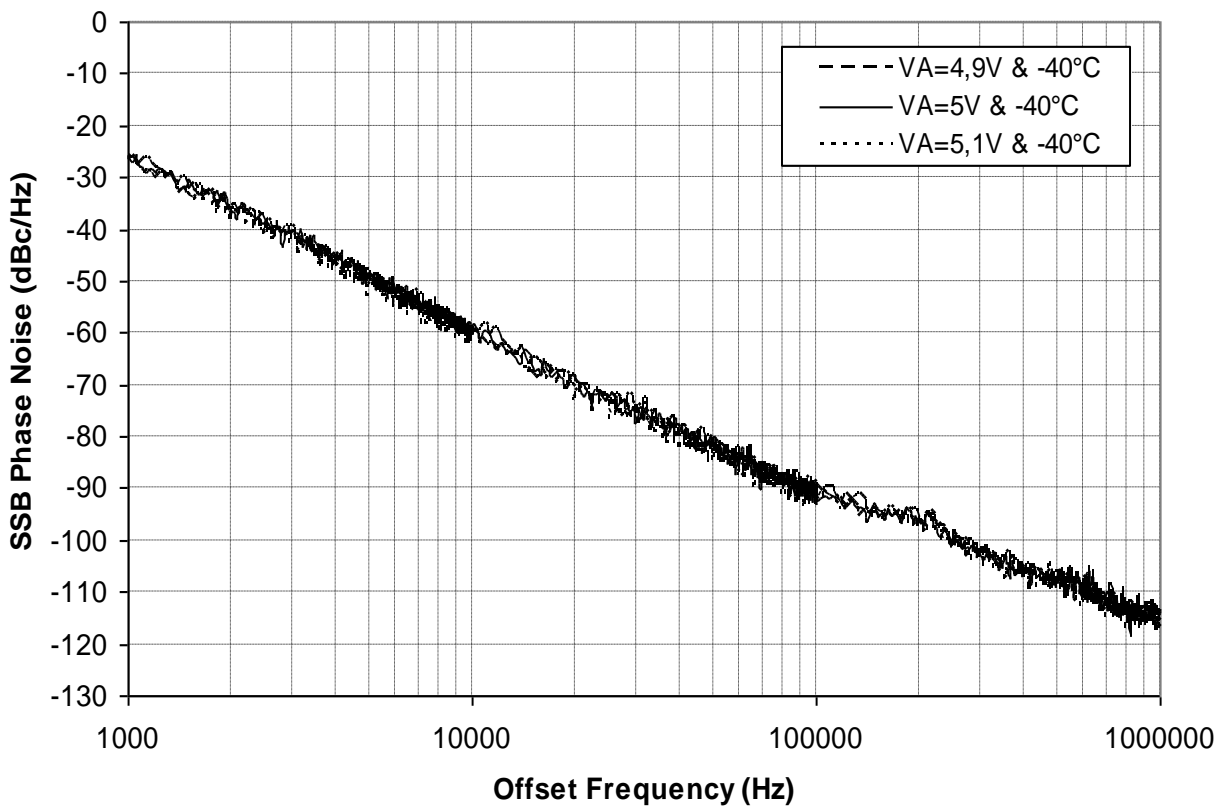

Phase Noise versus Offset frequency from carrier & +V @ $V_t=3V$, $T_{op}=+105^{\circ}C$

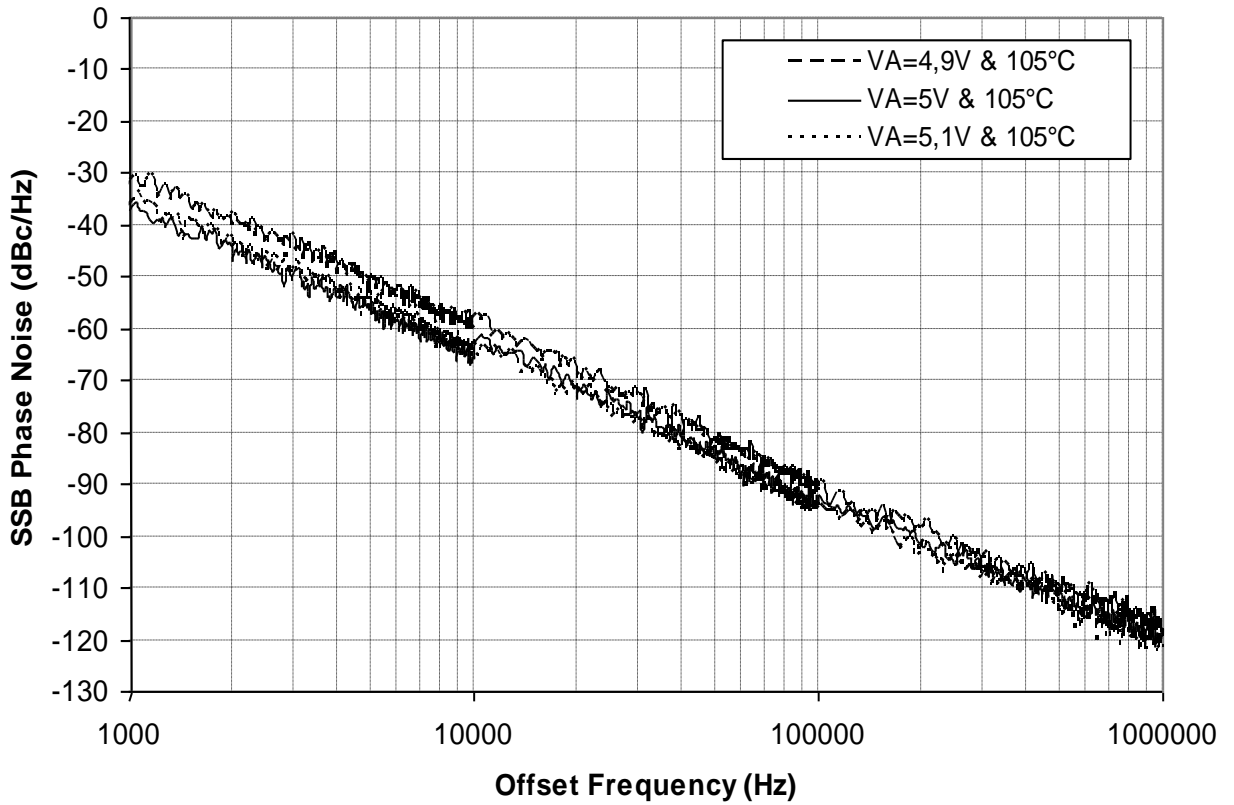

4th stage of the RF amplifier bias VB2 used for power setting

Output Power vs VB2 @ 24GHz

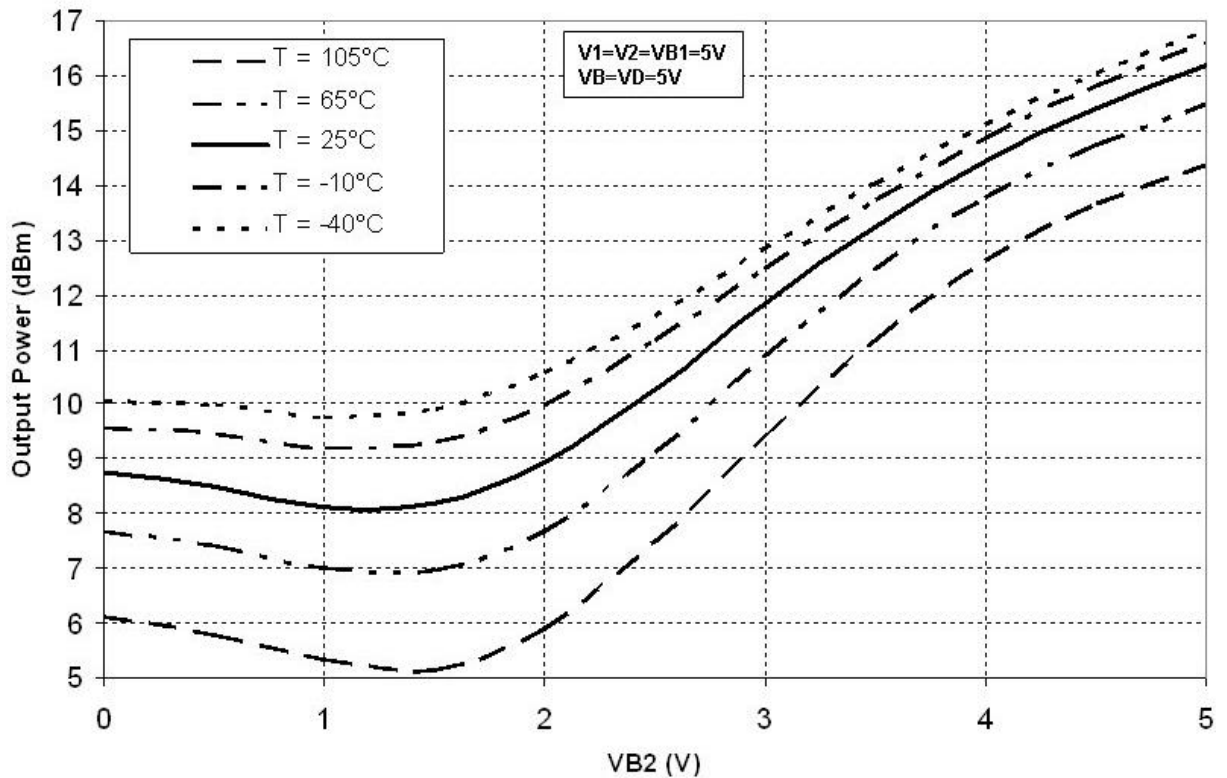

4th stage of the RF amplifier bias VB2 used for power setting

Current consumption vs VB2 @ 24GHz

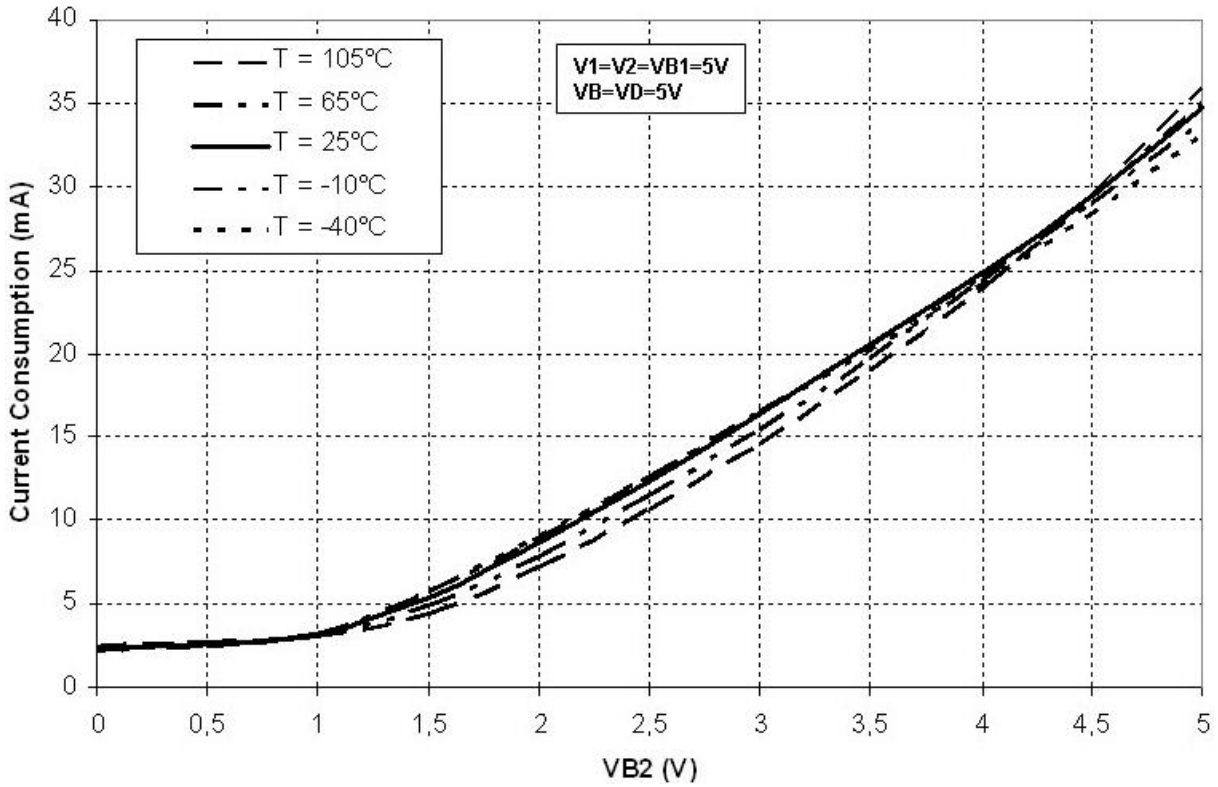

Prescaler and 12GHz buffer switching effect on VCO frequency (MHz)

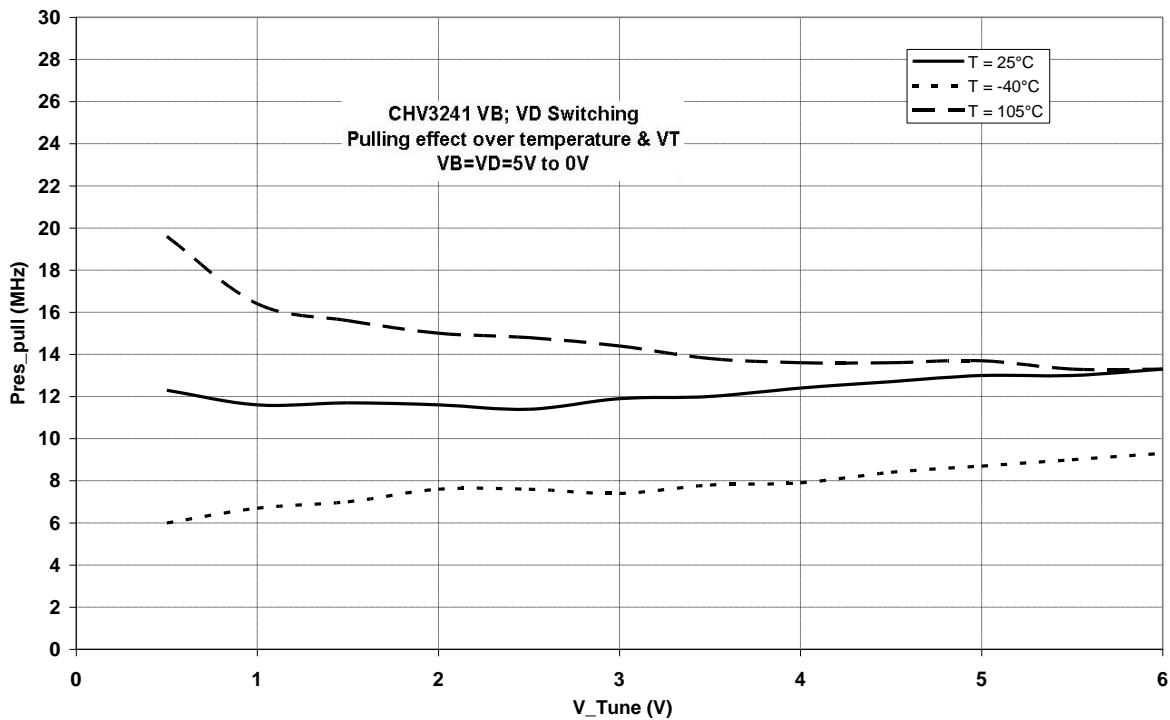

QFN Outlines and Pin-out ⁽¹⁾

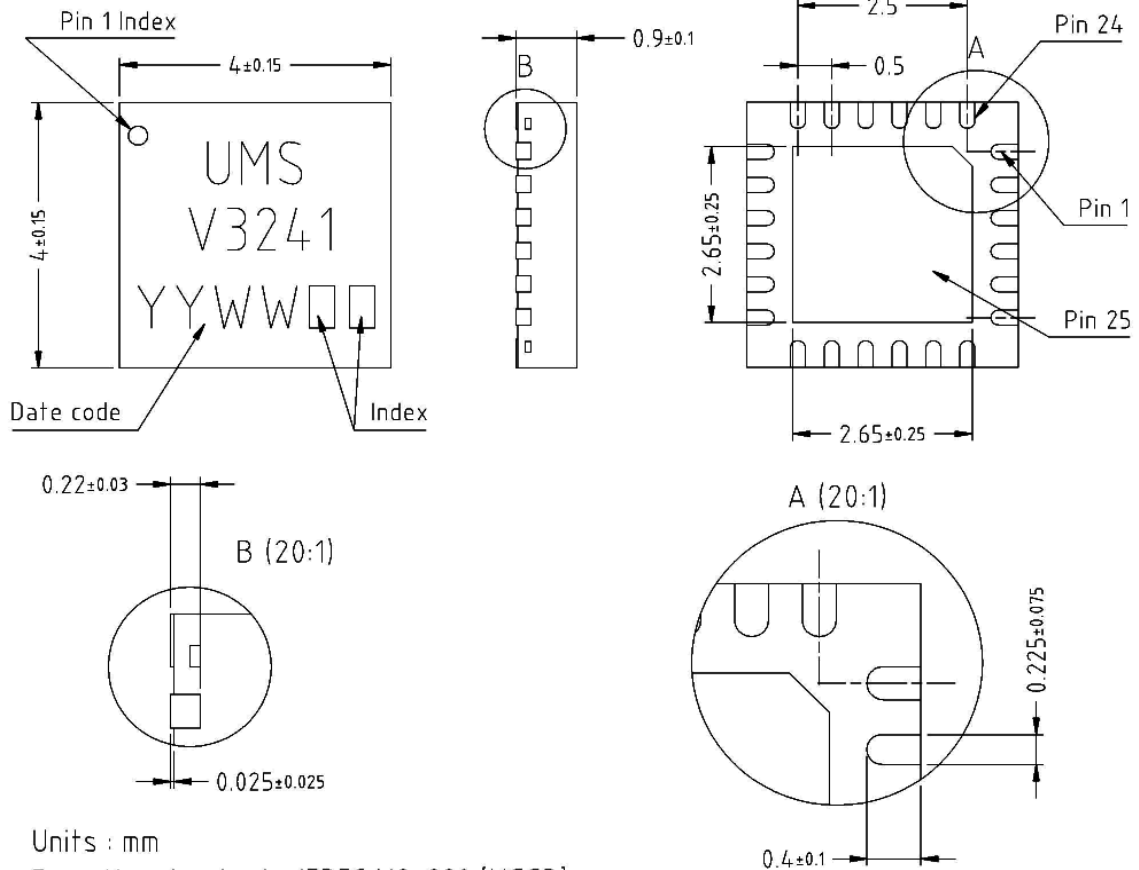

Units : mm

From the standard : JEDEC MO-220 [VGGD]

Matt tin, Lead free (Green)

1- Nc	9- Nc	17- Gnd	25- GND Exposed Pad
2- P	10- VB	18- Nc	
3- Nc	11- V1	19- Nc	
4- VT	12- Nc	20- VB2	
5- Nc	13- VB1	21- V2	
6- Nc	14- Nc	22- Nc	
7- Nc	15- Gnd	23- VD	
8- Nc	16- RF	24- Nc	

(1) The package outline drawing is given for indication. Refer to the application note AN0017 available at <https://www.ums-rf.com> for exact package dimensions.

QFN Pin-out description

Pin number	Pin name	Symbol Name	Description
15, 17, 25	<i>GND</i>		Ground
4	VT	V_Tune	Frequency Tuning Port
10,11,13, 20, 21, 23	VB, V1, VB1, VB2, V2, VD	+V	Positive supply voltage
10	VB		Positive supply voltage of 12GHz prescaler's buffer
11, 21	V1, V2		Positive supply voltage of the VCO core + the 24GHz buffer , 1 st stage
13	VB1		Positive supply voltage of the 24GHz buffer, 2 nd & 3 rd stages
20	VB2		Positive supply voltage of the 24GHz buffer, 4 th stages
23	VD		Positive supply voltage of the Prescaler
16	RF	F_out	RF output at 24GHz
2	P	F_out/1024	Prescaler output at 24MHz
1,3,5,6,7,8,9,12,14,18, 19, 22, 24	Nc		Not connected

External Components and bias configuration (recommended)

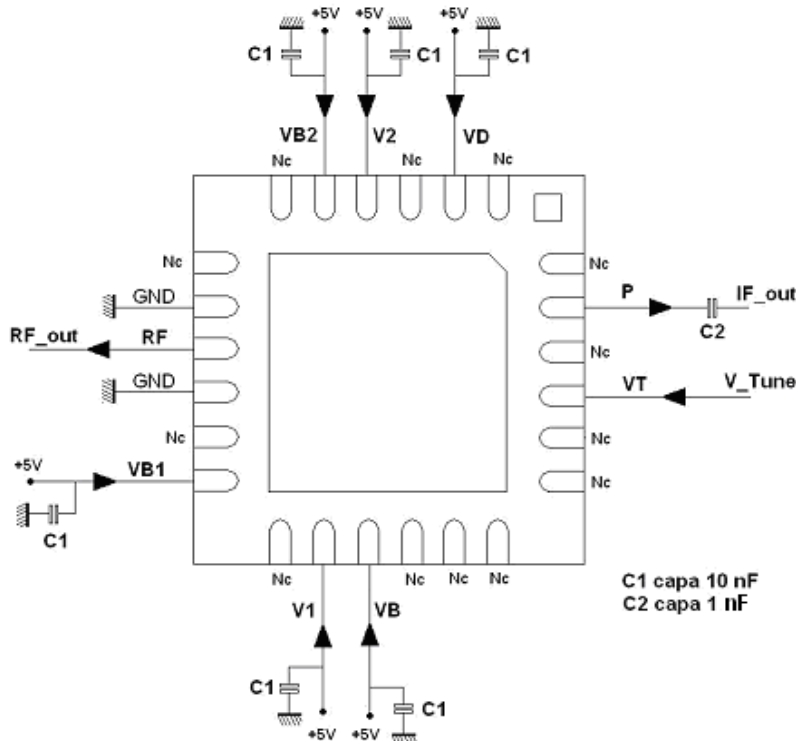

Important: A capacitor is required on the prescaler output port as a DC block (C2).

Fully Integrated HBT K-band VCO

CHV3241-QDG

Recommended Test Fixture (Ref. 97836) for measurements over Temperature Range

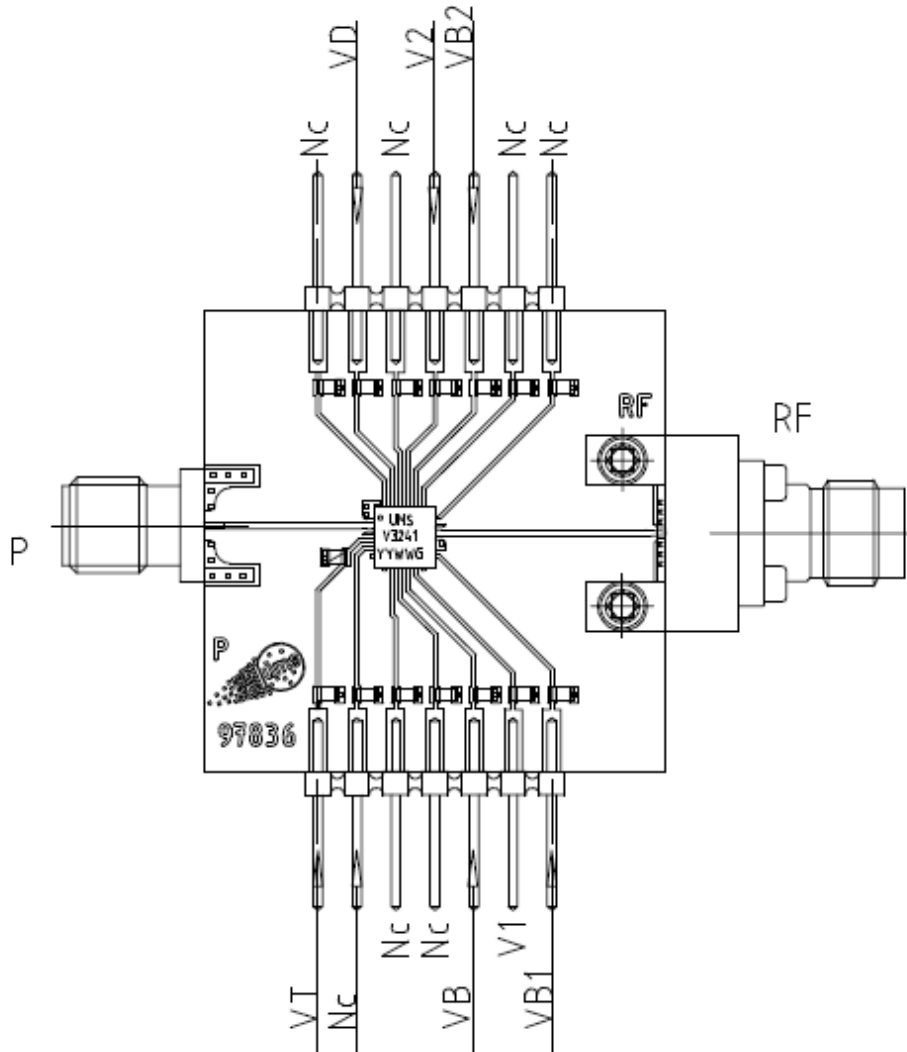

Rep	P/N	Qt	DESIGNATION	REF FABRICANT	FABRICANT
	61495564	1	Monture 30X30 EDG	SEMELLE	
	61497836	1	Demo board VCO	CIRCUIT 97836	
		1	Connecteur 2.9mm (DC-50GHz)	1492-03A-5	SOUTHWEST
		1	Connecteur RF SMA (DC-18 GHz)	PSF-S01-1,62MM	GIGALANE
		14	Condo 0603 X7R 10nF ±10% 50V	GRM1888R71H103K	MURATA
		1	Condo 0603 X5R 1µF ±10% 10V	C0603C105K8PAC	KEMET
		2	Barette Male 7x2 Contacts	4730334180400	Konfek COMATEL
		1	CHV3241QDG		

CHV3241-QDG

Fully Integrated HBT K-band VCO

Recommended Test Fixture PCB layout (Ref. 97836)

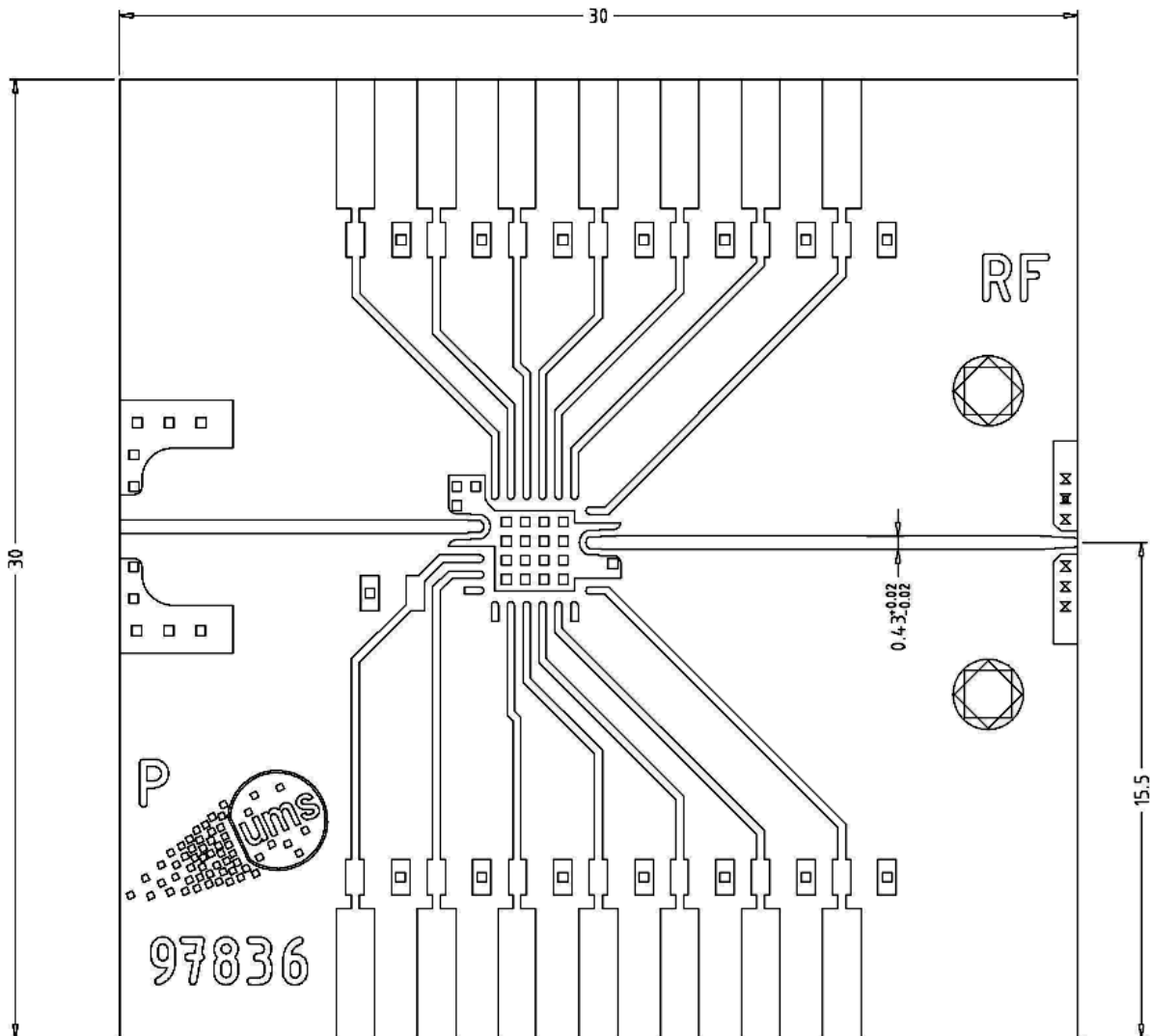

MATERIAL
 Ro4003 ROGERS
 Thickness : 0.008 in (0.203 mm)
 2 sides Cu 17,5µm

METALLIZATION
 Front side : Electroless Ni 5 - 7 µm
 Electroless Au 0.08 - 0.1 µm
 Back side : Electroless Ni 5 - 7 µm
 Electroless Au 0.08 - 0.1 µm

VIA HOLE

□	49	∅ 0.2 finish
⊗	6	∅ 0.35 finish
⊙	4	∅ 2 finish



Recommended ESD management

Norm	Value
MIL-STD-1686C	HBM Class 1 (<1000V)
ESD STM5.1-1998	HBM Class 0 (<250V)

Refer to the application note AN0020 available at <https://www.ums-rf.com> for ESD sensitivity and handling recommendations for the UMS package products.

Package Information

Parameter	
Package body material	RoHS-compliant Low stress Injection Molded Plastic
Lead finish	100% matte Sn
MSL Rating	MSL1

Recommended surface mount package assembly (UMS AN0017)

For volume production the SMD type package can be treated as a standard surface mount component (please refer to the IPC/JEDEC J-STD-020C standard or equivalent). The assembly on the motherboard can be performed using a standard assembly process (e.g. stencil solder printing, standard pick-and-place machinery, and solder reflow oven). However, caution should be taken to perform a good and reliable contact over the whole pad area.

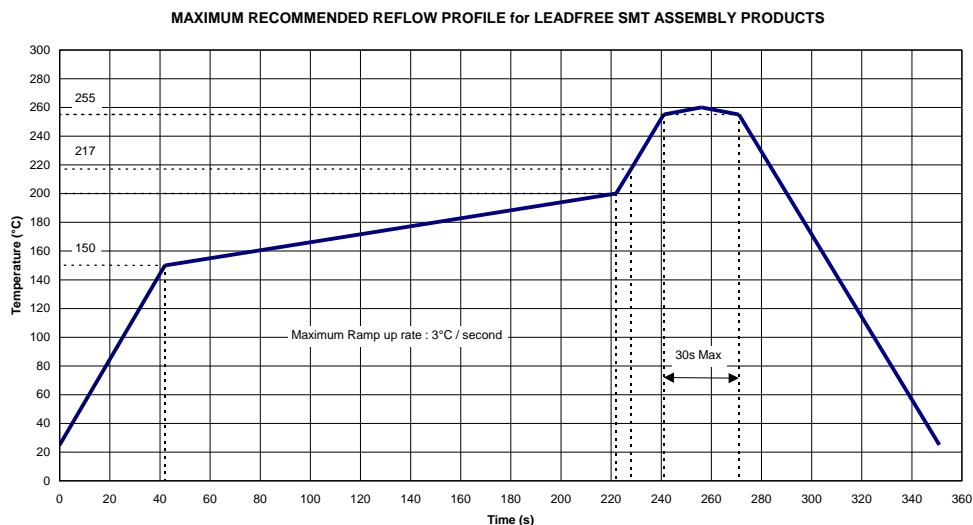

Recommendation:

The solder thickness after reflow should be typical 50µm [2 mils] and the lateral alignment between the package and the motherboard should be within 50µm [2 mils].

It is important for the performance of the product that the whole overlapping area between the motherboard and package pads is connected. Voids or other improper connections, in particular, between the ground pads on motherboard and package will lead to a deterioration of the RF performance and the heat dissipation. The latter effect can reduce drastically reliability and lifetime of the product.

Recommended environmental management

Refer to the application note AN0019 available at <https://www.ums-rf.com> for environmental data on UMS package products.

Ordering Information

24L-QFN4x4 Lead Free Package: CHV3241-QDG/XY

Stick: XY=20 Tape and reel: XY=21

Information furnished is believed to be accurate and reliable. However **United Monolithic Semiconductors S.A.S.** assumes no responsibility for the consequences of use of such information nor for any infringement of patents or other rights of third parties which may result from its use. No license is granted by implication or otherwise under any patent or patent rights of **United Monolithic Semiconductors S.A.S.**. Specifications mentioned in this publication are subject to change without notice. This publication supersedes and replaces all information previously supplied. **United Monolithic Semiconductors S.A.S.** products are not authorised for use as critical components in life support devices or systems without express written approval from **United Monolithic Semiconductors S.A.S.**